

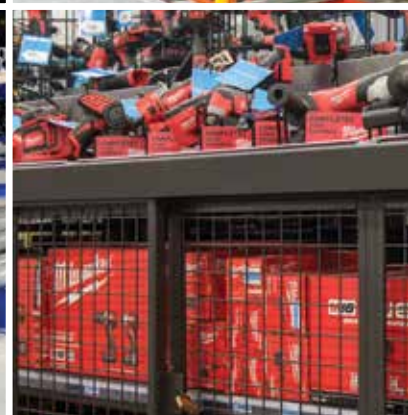

PRODUCTS AND PARTS CATALOG

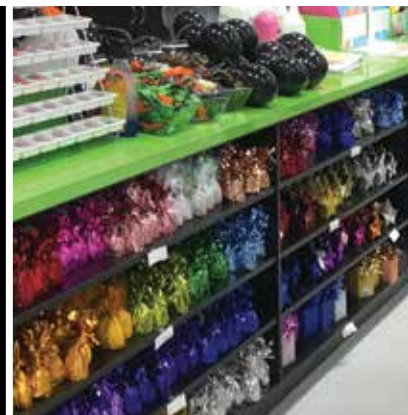

www.etalex.ca



Click on the product to go directly to its page.
Use Acrobat's search button to find a specific product.

COMMERCIAL SHELVING

- 04 E Series - Wall
- 06 E Series - Island
- 09 E Series - End Cap
- 12 S Series - Wall
- 15 S Series - Island
- 18 S Series - End Cap
- 21 C Series - Wall
- 22 C Series - Island and End Cap
- 23 C Series - Configurations

GROCERY

- 25 E Series - Wall, Island and End Cap
- 33 S Series - Wall, Island and End Cap
- 42 C Series - Wall, Island and End Cap
- 45 Profit Panel
- 46 Cold Rooms
- 56 Cigarette Cabinets
- 57 Reserves
- 58 Commercial Racking Systems

PHARMACY

- 64 E Series - Wall, Island and End Cap
- 72 S Series - Wall, Island and End Cap
- 81 C Series - Wall, Island and End Cap
- 84 End Cap Options
- 85 Lighted Shelves
- 86 RX Lab System for Laboratory
- 88 Optiwall
- 89 Laboratory Units
- 96 Displays

HARDWARE

- 103 E Series - Wall, Island and End Cap
- 111 S Series - Wall, Island and End Cap
- 120 C Series - Wall, Island and End Cap
- 123 Cabinets
- 124 Wire Mesh Doors
- 125 Displays
- 130 Slatwall Panels
- 131 Tool Section
- 139 Displays and Accessories

COMMERCIAL RACKING

- 148 Uprights
- 153 Beams
- 157 Security Bars
- 160 Warehouse Wire mesh Panels
- 162 Dividers/Spacers
- 163 Hardware
- 164 Shims
- 165 Protectors
- 168 Miscellaneous

- 169 Doors and Stoppers
- 171 Caps and Brackets
- 173 Accessories
- 175 Warehouse Racking
- 178 Displays and Brackets
- 184 Plumbing
- 185 Ceiling Light and Fan Displays
- 187 Cable and Wire Displays
- 189 Miscellaneous Displays
- 191 Rug Displays
- 193 Carpet Displays
- 194 Floor Covering Displays
- 198 Handles and Locks Displays
- 199 Door Displays
- 200 Miscellaneous Displays
- 202 Accessories for Tools
- 206 Light Racking - Type WS
- 209 Warehousing System
- 211 Supplementary Products

COUNTERS

- 219 Cash Counters
- 223 Cosmetic Counters
- 226 Customer Service Counters
- 228 Pharmacy and Laboratory Counters
- 231 Custom-Made Counters

DISPLAYS

- 234 4 -Sided Displays
- 236 Cosmetic Displays
- 237 Magazine Displays
- 238 Wire Mesh Displays
- 239 Custom Displays

ACCESSORIES AND COMPONENTS

- 242 Shelves
- 245 Brackets
- 247 Miscellaneous Accessories
- 248 Wire Mesh Baskets
- 249 Wire Mesh Shelves and Dividers
- 250 Brackets for Baskets
- 251 Wire Mesh Shelves
- 254 Wire Mesh Baskets
- 255 Miscellaneous Accessories
- 256 Hooks
- 261 Accessories
- 272 Frames for Shelves
- 273 Accessories - Systems
- 276 Acrylic Fence
- 279 Cigarette Cabinets
- 280 Slatwall Panels
- 284 End Caps
- 289 Components

INDEX



IN THIS SECTION

E SERIES

S SERIES

C SERIES

COMMERCIAL SHELVING

E SERIES - WALL



EXAMPLE*:
36 in. long x 84 in. high wall with a 24 in.
deep base shelf

PLAIN METAL BACK - REMOVABLE SHOE GUARD

	STRUCTURE CODE	AVAILABLE LENGTHS in 6-inch increments	AVAILABLE HEIGHTS in 6-inch increments	AVAILABLE DEPTHS in 2-inch increments
STARTER	MDUJ (L x H x Base)	24 to 48 in.	48 to 120 in.	6 to 30 in.
* Example:	MDUJ368424	36	84	24
ADDITION	MAUJ (L x H x Base)	24 to 48 in.	48 to 120 in.	6 to 30 in.
* Example:	MAUJ368424	36	84	24

PLAIN METAL BACK - KICKPLATE

	STRUCTURE CODE	AVAILABLE LENGTHS in 6-inch increments	AVAILABLE HEIGHTS in 6-inch increments	AVAILABLE DEPTHS in 2-inch increments
STARTER	MDUP (L x H x Base)	24 to 48 in.	48 to 120 in.	6 to 30 in.
* Example:	MDUP368424	36	84	24
ADDITION	MAUP (L x H x Base)	24 to 48 in.	48 to 120 in.	6 to 30 in.
* Example:	MAUP368424	36	84	24

This is an example of coding based on the image above. Structure codes vary according to the size chosen.

E SERIES - WALL



PERFORATED BACK - REMOVABLE SHOE GUARD

	STRUCTURE CODE	AVAILABLE LENGTHS in 6-inch increments	AVAILABLE HEIGHTS in 6-inch increments	AVAILABLE DEPTHS in 2-inch increments
STARTER	MDPJ (L x H x Base)	24 to 48 in.	48 to 120 in.	6 to 30 in.
* Example:	MDPJ368424	36	84	24
ADDITION	MAPJ (L x H x Base)	24 to 48 in.	48 to 120 in.	6 to 30 in.
* Example:	MAPJ368424	36	84	24

PERFORATED BACK - KICKPLATE

	STRUCTURE CODE	AVAILABLE LENGTHS in 6-inch increments	AVAILABLE HEIGHTS in 6-inch increments	AVAILABLE DEPTHS in 2-inch increments
STARTER	MDPP (L x H x Base)	24 to 48 in.	48 to 120 in.	6 to 30 in.
* Example:	MDPP368424	36	84	24
ADDITION	MAPP (L x H x Base)	24 to 48 in.	48 to 120 in.	6 to 30 in.
* Example:	MAPP368424	36	84	24

This is an example of coding based on the image above. Structure codes vary according to the size chosen.

E SERIES - ISLAND

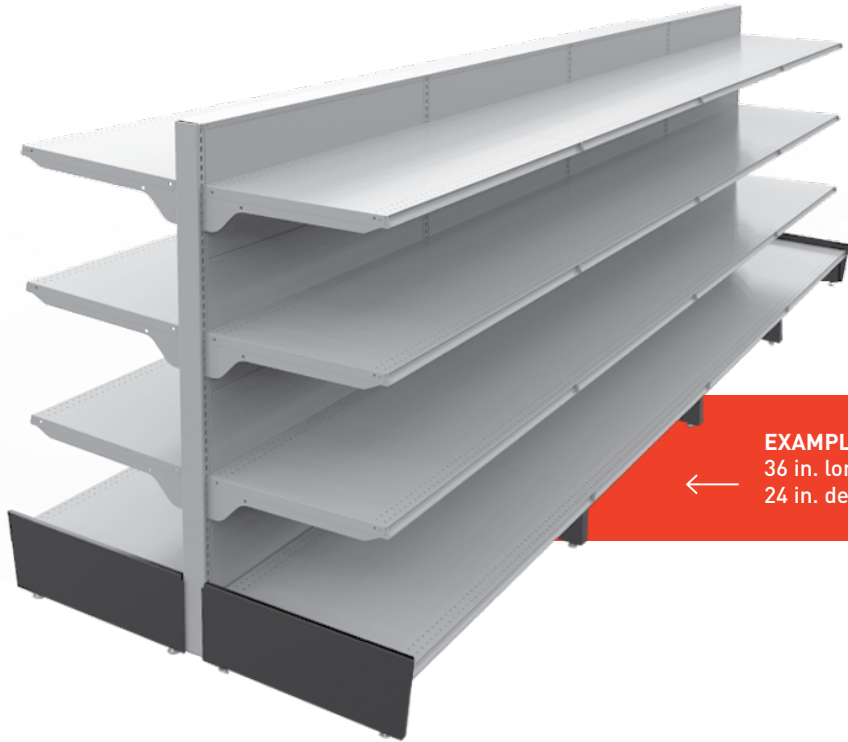

PLAIN METAL BACK - REMOVABLE SHOE GUARD

	STRUCTURE CODE	AVAILABLE LENGTHS in 6-inch increments	AVAILABLE HEIGHTS in 6-inch increments	AVAILABLE DEPTHS in 2-inch increments
STARTER	IDUJ (L x H x Base)	24 to 48 in.	48 to 120 in.	6 to 30 in.
* Example:	IDUJ36842424	36	84	24
ADDITION	IAUJ (L x H x Base)	24 to 48 in.	48 to 120 in.	6 to 30 in.
* Example:	IAUJ36842424	36	84	24

PLAIN METAL BACK - KICKPLATE

	STRUCTURE CODE	AVAILABLE LENGTHS in 6-inch increments	AVAILABLE HEIGHTS in 6-inch increments	AVAILABLE DEPTHS in 2-inch increments
STARTER	IDUP (L x H x Base)	24 to 48 in.	48 to 120 in.	6 to 30 in.
* Example:	IDUP36842424	36	84	24
ADDITION	IAUP (L x H x Base)	24 to 48 in.	48 to 120 in.	6 to 30 in.
* Example:	IAUP36842424	36	84	24

This is an example of coding based on the image above. Structure codes vary according to the size chosen.

E SERIES - ISLAND

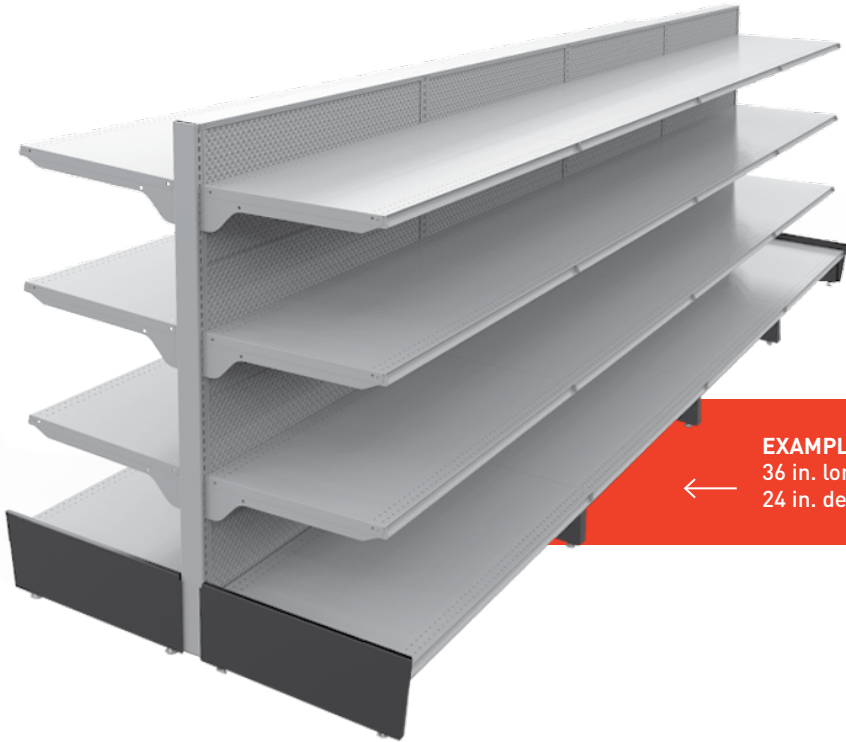

EXAMPLE*:

36 in. long x 84 in. high island with a 24 in. deep base shelf on each side

PERFORATED BACK- REMOVABLE SHOE GUARD

	STRUCTURE CODE	AVAILABLE LENGTHS in 6-inch increments	AVAILABLE HEIGHTS in 6-inch increments	AVAILABLE DEPTHS in 2-inch increments
STARTER	IDPJ (L x H x Base)	24 to 48 in.	48 to 120 in.	6 to 30 in.
* Example:	IDPJ36842424	36	84	24
ADDITION	IAPJ (L x H x Base)	24 to 48 in.	48 to 120 in.	6 to 30 in.
* Example:	IAPJ36842424	36	84	24

PERFORATED BACK - KICKPLATE

	STRUCTURE CODE	AVAILABLE LENGTHS in 6-inch increments	AVAILABLE HEIGHTS in 6-inch increments	AVAILABLE DEPTHS in 2-inch increments
STARTER	IDPP (L x H x Base)	24 to 48 in.	48 to 120 in.	6 to 30 in.
* Example:	IDPP36842424	36	84	24
ADDITION	IAPP (L x H x Base)	24 to 48 in.	48 to 120 in.	6 to 30 in.
* Example:	IAPP36842424	36	84	24

This is an example of coding based on the image above. Structure codes vary according to the size chosen.

E SERIES - ISLAND



EXAMPLE*:

36 in. long x 84 in. high island with a 24 in. deep base shelf on each side

SLATWALL BACK - REMOVABLE SHOE GUARD

	STRUCTURE CODE	AVAILABLE LENGTHS in 6-inch increments	AVAILABLE HEIGHTS in 6-inch increments	AVAILABLE DEPTHS in 2-inch increments
STARTER	-	24 to 48 in.	48 to 120 in.	6 to 30 in.
* Example:	-	36	84	24
ADDITION	-	24 to 48 in.	48 to 120 in.	6 to 30 in.
* Example:	-	36	84	24

SLATWALL BACK - KICKPLATE

	STRUCTURE CODE	AVAILABLE LENGTHS in 6-inch increments	AVAILABLE HEIGHTS in 6-inch increments	AVAILABLE DEPTHS in 2-inch increments
STARTER	-	24 to 48 in.	48 to 120 in.	6 to 30 in.
* Example:	-	36	84	24
ADDITION	-	24 to 48 in.	48 to 120 in.	6 to 30 in.
* Example:	-	36	84	24

This is an example of coding based on the image above. Structure codes vary according to the size chosen.

E SERIES - END CAP



EXAMPLE*:
36 in. long x 84 in. high island with
a 24 in. deep base shelf

PLAIN METAL BACK - REMOVABLE SHOE GUARD

	STRUCTURE CODE	AVAILABLE LENGTHS in 6-inch increments	AVAILABLE HEIGHTS in 6-inch increments	AVAILABLE DEPTHS in 2-inch increments
STARTER	BDUJ (L x H x Base)	24 to 48 in.	48 to 120 in.	6 to 30 in.
* Example:	BDUJ368424	36	84	24
ADDITION	BAUJ (L x H x Base)	24 to 48 in.	48 to 120 in.	6 to 30 in.
* Example:	BAUJ368424	36	84	24

PLAIN METAL BACK - KICKPLATE

	STRUCTURE CODE	AVAILABLE LENGTHS in 6-inch increments	AVAILABLE HEIGHTS in 6-inch increments	AVAILABLE DEPTHS in 2-inch increments
STARTER	BDUP (L x H x Base)	24 to 48 in.	48 to 120 in.	6 to 30 in.
* Example:	BDUP368424	36	84	24
ADDITION	BAUP (L x H x Base)	24 to 48 in.	48 to 120 in.	6 to 30 in.
* Example:	BAUP368424	36	84	24

This is an example of coding based on the image above. Structure codes vary according to the size chosen.
See the **Accessories and Components** section for end caps

E SERIES - END CAP

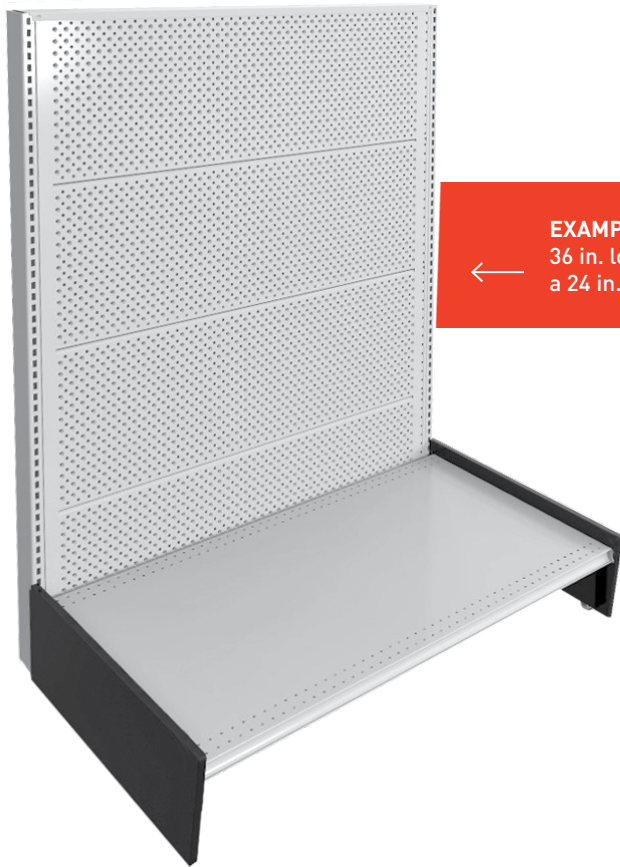

EXAMPLE*:
 ← 36 in. long x 84 in. high with
 a 24 in. deep base shelf

PERFORATED BACK - REMOVABLE SHOE GUARD

	STRUCTURE CODE	AVAILABLE LENGTHS in 6-inch increments	AVAILABLE HEIGHTS in 6-inch increments	AVAILABLE DEPTHS in 2-inch increments
STARTER	BDPJ (L x H x Base)	24 to 48 in.	48 to 120 in.	6 to 30 in.
* Example:	BDPJ368424	36	84	24
ADDITION	BAPJ (L x H x Base)	24 to 48 in.	48 to 120 in.	6 to 30 in.
* Example:	BAPJ368424	36	84	24

PERFORATED BACK - KICKPLATE

	STRUCTURE CODE	AVAILABLE LENGTHS in 6-inch increments	AVAILABLE HEIGHTS in 6-inch increments	AVAILABLE DEPTHS in 2-inch increments
STARTER	BDPP (L x H x Base)	24 to 48 in.	48 to 120 in.	6 to 30 in.
* Example:	BDPP368424	36	84	24
ADDITION	BAPP (L x H x Base)	24 to 48 in.	48 to 120 in.	6 to 30 in.
* Example:	BAPP368424	36	84	24

This is an example of coding based on the image above. Structure codes vary according to the size chosen.
 See the **Accessories and Components** section for end caps

E SERIES - END CAP



EXAMPLE*:
 ← 36 in. long x 84 in. high with
 a 24 in. deep base shelf

SLATWALL BACK - REMOVABLE SHOE GUARD

	STRUCTURE CODE	AVAILABLE LENGTHS in 6-inch increments	AVAILABLE HEIGHTS in 6-inch increments	AVAILABLE DEPTHS in 2-inch increments
STARTER	-	24 to 48 in.	48 to 120 in.	6 to 30 in.
* Example:	-	36	84	24
ADDITION	-	24 to 48 in.	48 to 120 in.	6 to 30 in.
* Example:	-	36	84	24

SLATWALL BACK - KICKPLATE

	STRUCTURE CODE	AVAILABLE LENGTHS in 6-inch increments	AVAILABLE HEIGHTS in 6-inch increments	AVAILABLE DEPTHS in 2-inch increments
STARTER	-	24 to 48 in.	48 to 120 in.	6 to 30 in.
* Example:	-	36	84	24
ADDITION	-	24 to 48 in.	48 to 120 in.	6 to 30 in.
* Example:	-	36	84	24

This is an example of coding based on the image above. Structure codes vary according to the size chosen.
 See the **Accessories and Components** section for end caps

S SERIES - WALL



EXAMPLE*:
36 in. long x 84 in. high wall with a 24 in.
deep base shelf

SOLID MASONITE BACK - SHOE GUARD

	STRUCTURE CODE	AVAILABLE LENGTHS in 6-inch increments	AVAILABLE HEIGHTS in 6-inch increments	AVAILABLE DEPTHS in 2-inch increments
STARTER	SMBDUJ3B (L x H x Base)	24 to 48 in.	48 to 120 in.	6 to 30 in.
* Example:	SMBDUJ3B368424	36	84	24
ADDITION	SMBAUJ3B (L x H x Base)	24 to 48 in.	48 to 120 in.	6 to 30 in.
* Example:	SMBAUJ3B368424	36	84	24
BASE SHELF HEIGHT (2 heights available): 5 3/4 in. H <i>Low base</i> (from floor to shelf) 7 1/4 in. H <i>High base</i> (from floor to shelf)				

SOLID MASONITE BACK - KICKPLATE

	STRUCTURE CODE	AVAILABLE LENGTHS in 6-inch increments	AVAILABLE HEIGHTS in 6-inch increments	AVAILABLE DEPTHS in 2-inch increments
STARTER	SMBDPJ3B (L x H x Base)	24 to 48 in.	48 to 120 in.	6 to 30 in.
* Example:	SMBDPJ3B368424	36	84	24
ADDITION	SMBAUP3B (L x H x Base)	24 to 48 in.	48 to 120 in.	6 to 30 in.
* Example:	SMBAUP3B368424	36	84	24
BASE SHELF HEIGHT (2 heights available): 5 3/4 in. H <i>Low base</i> (from floor to shelf) 7 1/4 in. H <i>High base</i> (from floor to shelf)				

This is an example of coding based on the image above. Structure codes vary according to the size chosen.

S SERIES - WALL

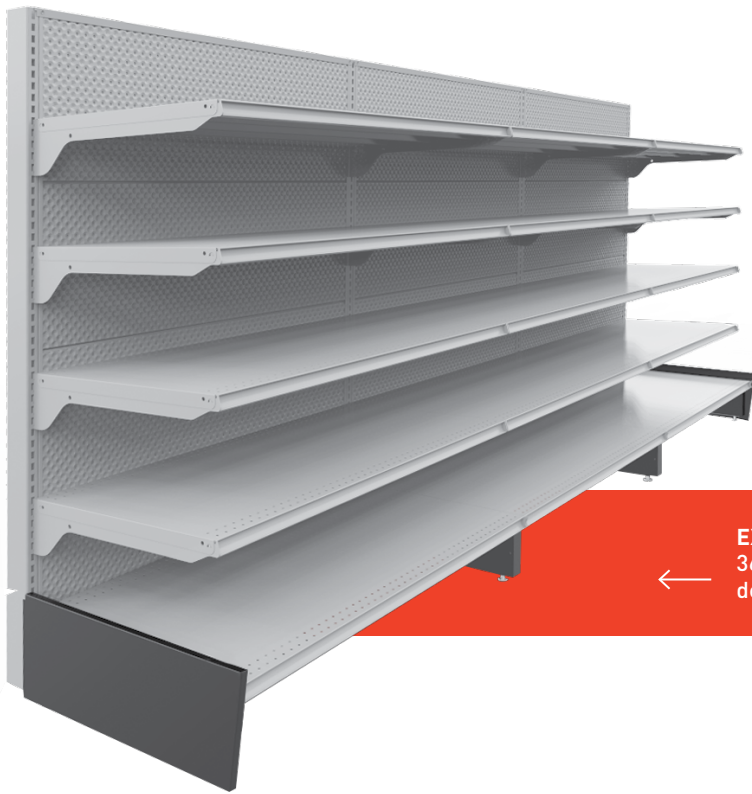

EXAMPLE*:
36 in. long x 84 in. high wall with a 24 in.
deep base shelf

PERFORATED MASONITE BACK - SHOE GUARD

	STRUCTURE CODE	AVAILABLE LENGTHS in 6-inch increments	AVAILABLE HEIGHTS in 6-inch increments	AVAILABLE DEPTHS in 2-inch increments
STARTER	SMBDPJ3B (L x H x Base)	24 to 48 in.	48 to 120 in.	6 to 30 in.
* Example:	SMBDPJ3B368424	36	84	24
ADDITION	SMBAPJ3B (L x H x Base)	24 to 48 in.	48 to 120 in.	6 to 30 in.
* Example:	SMBAPJ3B368424	36	84	24
BASE SHELF HEIGHT (2 heights available): 5 3/4 in. H <i>Low base</i> (from floor to shelf) 7 1/4 in. H <i>High base</i> (from floor to shelf)				

PERFORATED MASONITE BACK - KICKPLATE

	STRUCTURE CODE	AVAILABLE LENGTHS in 6-inch increments	AVAILABLE HEIGHTS in 6-inch increments	AVAILABLE DEPTHS in 2-inch increments
STARTER	SMBDPP3B (L x H x Base)	24 to 48 in.	48 to 96 in.	10 to 30 in.
* Example:	SMBDPP3B368424	36	84	24
ADDITION	SMBAPP3B (L x H x Base)	24 to 48 in.	48 to 96 in.	10 to 30 in.
* Example:	SMBAPP3B368424	36	84	24
BASE SHELF HEIGHT (2 heights available): 5 3/4 in. H <i>Low base</i> (from floor to shelf) 7 1/4 in. H <i>High base</i> (from floor to shelf)				

This is an example of coding based on the image above. Structure codes vary according to the size chosen.

S SERIES - WALL



EXAMPLE*:
36 in. long x 84 in. high wall with a 24 in.
deep base shelf

SLATWALL BACK - SHOE GUARD

	STRUCTURE CODE	AVAILABLE LENGTHS in 6-inch increments	AVAILABLE HEIGHTS in 6-inch increments	AVAILABLE DEPTHS in 2-inch increments
STARTER	-	24 to 48 in.	48 to 120 in.	6 to 30 in.
* Example:	-	36	84	24
ADDITION	-	24 to 48 in.	48 to 120 in.	6 to 30 in.
* Example:	-	36	84	24
BASE SHELF HEIGHT (2 heights available): 5 3/4 in. H <i>Low base</i> (from floor to shelf) 7 1/4 in. H <i>High base</i> (from floor to shelf)				

SLATWALL BACK - KICKPLATE

	STRUCTURE CODE	AVAILABLE LENGTHS in 6-inch increments	AVAILABLE HEIGHTS in 6-inch increments	AVAILABLE DEPTHS in 2-inch increments
STARTER	SMSDIP3B (L x H x Base)	24 to 48 in.	48 to 96 in.	10 to 30 in.
* Example:	SMSDIP3B36842424B	36	84	24
ADDITION	SMSAIP3B (L x H x Base)	24 to 48 in.	48 to 96 in.	10 to 30 in.
* Example:	SMSAIP3B36842424B	36	84	24
BASE SHELF HEIGHT (2 heights available): 5 3/4 in. H <i>Low base</i> (from floor to shelf) 7 1/4 in. H <i>High base</i> (from floor to shelf)				

This is an example of coding based on the image above. Structure codes vary according to the size chosen.

S SERIES - ISLAND

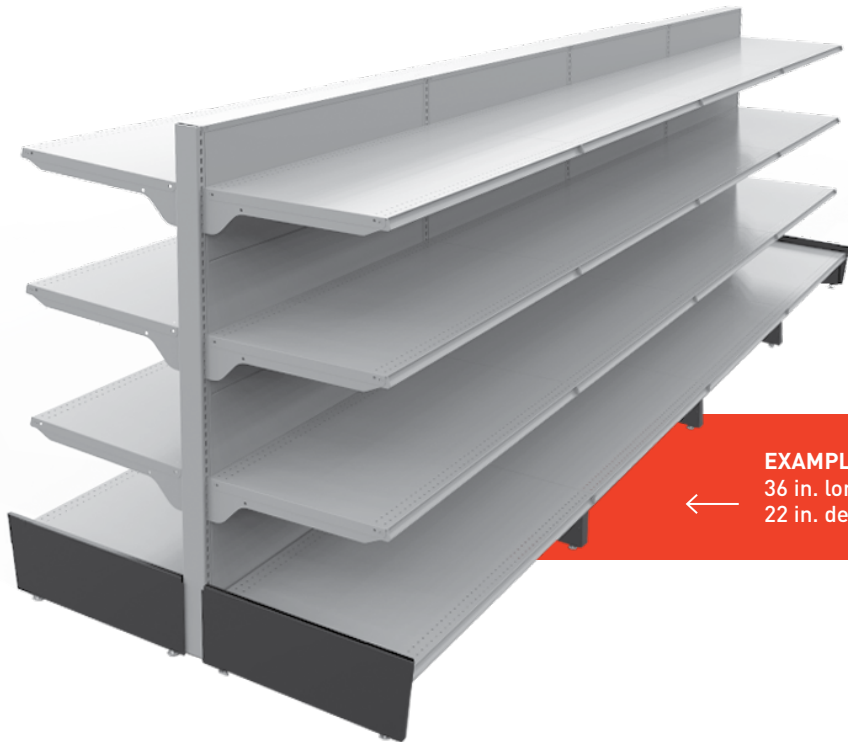

EXAMPLE*:

36 in. long x 84 in. high island with a 22 in. deep base shelf on each side

SOLID MASONITE BACK - SHOE GUARD

	STRUCTURE CODE	AVAILABLE LENGTHS in 6-inch increments	AVAILABLE HEIGHTS in 6-inch increments	AVAILABLE DEPTHS in 2-inch increments
STARTER	SIBDUJ3B (L x H x Base)	24 to 48 in.	48 to 120 in.	6 to 30 in.
* Example:	SIBDUJ3B36842222	36	84	22
ADDITION	SIBAUJ3B (L x H x Base)	24 to 48 in.	48 to 120 in.	6 to 30 in.
* Example:	SIBAUJ3B36842222	36	84	22
BASE SHELF HEIGHT (2 heights available): 5 3/4 in. H <i>Low base</i> (from floor to shelf) 7 1/4 in. H <i>High base</i> (from floor to shelf)				

SOLID MASONITE BACK - KICKPLATE

	STRUCTURE CODE	AVAILABLE LENGTHS in 6-inch increments	AVAILABLE HEIGHTS in 6-inch increments	AVAILABLE DEPTHS in 2-inch increments
STARTER	SIBDUP3B (L x H x Base)	24 to 48 in.	48 to 96 in.	10 to 30 in.
* Example:	SIBDUP3B36842222	36	84	22
ADDITION	SIBAU3B (L x H x Base)	24 to 48 in.	48 to 96 in.	10 to 30 in.
* Example:	SIBAU3B36842222	36	84	22
BASE SHELF HEIGHT (2 heights available): 5 3/4 in. H <i>Low base</i> (from floor to shelf) 7 1/4 in. H <i>High base</i> (from floor to shelf)				

This is an example of coding based on the image above. Structure codes vary according to the size chosen.

S SERIES - ISLAND



← **EXAMPLE*:**
36 in. long x 84 in. high island with a
22 in. deep base shelf on each side

PERFORATED MASONITE BACK - SHOE GUARD

	STRUCTURE CODE	AVAILABLE LENGTHS in 6-inch increments	AVAILABLE HEIGHTS in 6-inch increments	AVAILABLE DEPTHS in 2-inch increments
STARTER	SIBDPJ3B (L x H x Base)	24 to 48 in.	48 to 96 in.	10 to 30 in.
* Example:	SIBDPJ3B36842222	36	84	22
ADDITION	SIBAPJ3B (L x H x Base)	24 to 48 in.	48 to 96 in.	10 to 30 in.
* Example:	SIBAPJ3B36842222	36	84	22
BASE SHELF HEIGHT (2 heights available): 5 3/4 in. H <i>Low base</i> (from floor to shelf) 7 1/4 in. H <i>High base</i> (from floor to shelf)				

PERFORATED MASONITE BACK - KICKPLATE

	STRUCTURE CODE	AVAILABLE LENGTHS in 6-inch increments	AVAILABLE HEIGHTS in 6-inch increments	AVAILABLE DEPTHS in 2-inch increments
STARTER	SIBDPP3B (L x H x Base)	24 to 48 in.	48 to 96 in.	10 to 30 in.
* Example:	SIBDPP3B36842222	36	84	22
ADDITION	SIBAPP3B (L x H x Base)	24 to 48 in.	48 to 96 in.	10 to 30 in.
* Example:	SIBAPP3B36842222	36	84	22
BASE SHELF HEIGHT (2 heights available): 5 3/4 in. H <i>Low base</i> (from floor to shelf) 7 1/4 in. H <i>High base</i> (from floor to shelf)				

This is an example of coding based on the image above. Structure codes vary according to the size chosen.

S SERIES - ISLAND: MASONITE BACK



SLATWALL BACK - KICKPLATE

	STRUCTURE CODE	AVAILABLE LENGTHS in 6-inch increments	AVAILABLE HEIGHTS in 6-inch increments	AVAILABLE DEPTHS in 2-inch increments
STARTER	SISDIP3B (L x H x Base)	24 to 48 in.	48 to 96 in.	10 to 30 in.
* Example:	SISDIP3B36842424B	36	84	24
ADDITION	SISAIP3B (L x H x Base)	24 to 48 in.	48 to 96 in.	10 to 30 in.
* Example:	SISAIP3B36842424B	36	84	24
BASE SHELF HEIGHT (2 heights available): 5 3/4 in. H <i>Low base</i> (from floor to shelf) 7 1/4 in. H <i>High base</i> (from floor to shelf)				

This is an example of coding based on the image above. Structure codes vary according to the size chosen.

S SERIES - END CAP

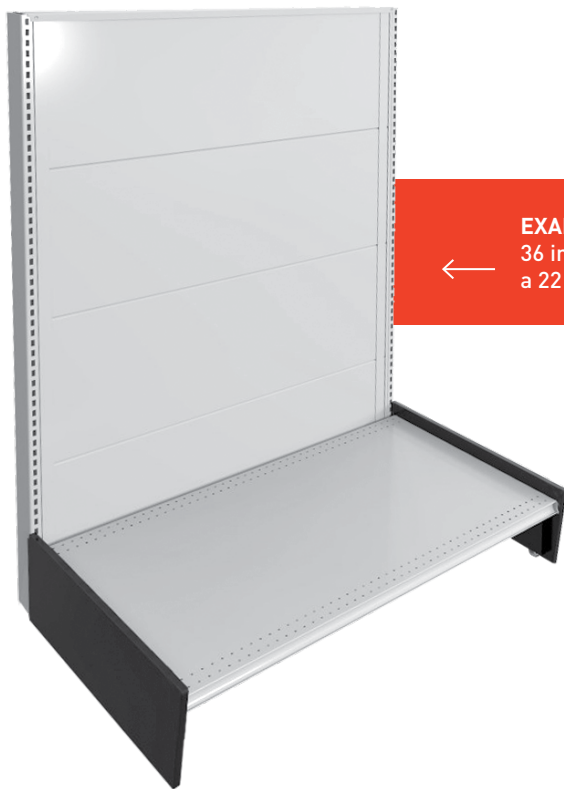

EXAMPLE*:

36 in. long x 96 in. high island with a 22 in. deep base shelf

SOLID MASONITE BACK - SHOE GUARD

	STRUCTURE CODE	AVAILABLE LENGTHS in 6-inch increments	AVAILABLE HEIGHTS in 6-inch increments	AVAILABLE DEPTHS in 2-inch increments
STARTER	SBBDUJ3H (L x H x Base)	24 to 48 in.	48 to 96 in.	10 to 30 in.
* Example:	SBBDUJ3H369624	36	96	24
ADDITION	SBBAUJ3H (L x H x Base)	24 to 48 in.	48 to 96 in.	10 to 30 in.
* Example:	SBBAUJ3H369624	36	96	24
BASE SHELF HEIGHT (2 heights available): 5 3/4 in. H <i>Low base</i> (from floor to shelf) 7 1/4 in. H <i>High base</i> (from floor to shelf)				

SOLID MASONITE BACK - KICKPLATE

	STRUCTURE CODE	AVAILABLE LENGTHS in 6-inch increments	AVAILABLE HEIGHTS in 6-inch increments	AVAILABLE DEPTHS in 2-inch increments
STARTER	SBBDUP3H (L x H x Base)	24 to 48 in.	48 to 96 in.	10 to 30 in.
* Example:	SBBDUP3H369624	36	96	24
ADDITION	SBBAUP3H (L x H x Base)	24 to 48 in.	48 to 96 in.	10 to 30 in.
* Example:	SBBAUP3H369624	36	96	24
BASE SHELF HEIGHT (2 heights available): 5 3/4 in. H <i>Low base</i> (from floor to shelf) 7 1/4 in. H <i>High base</i> (from floor to shelf)				

*This is an example of coding based on the image above. Structure codes vary according to the size chosen. See the **Accessories and Components** section for end caps*

S SERIES - END CAP

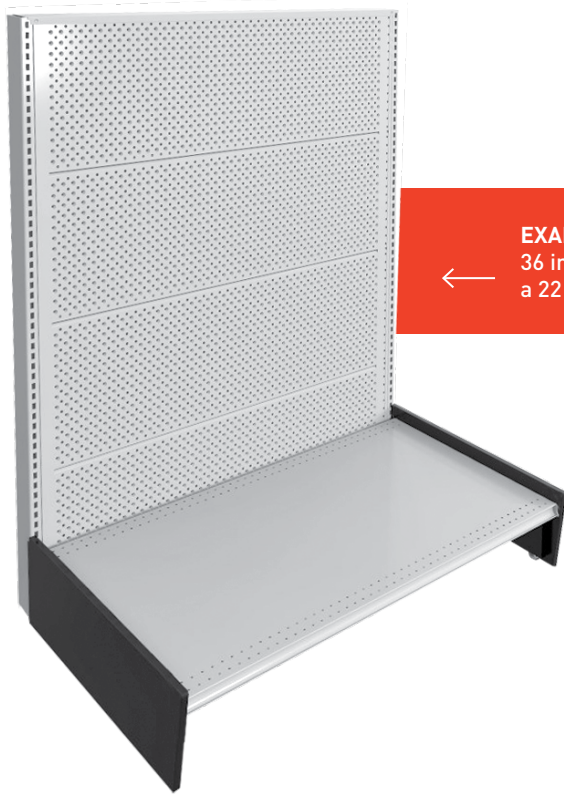

EXAMPLE*:

36 in. long x 96 in. high island with
a 22 in. deep base shelf



PERFORATED MASONITE BACK - SHOE GUARD

	STRUCTURE CODE	AVAILABLE LENGTHS in 6-inch increments	AVAILABLE HEIGHTS in 6-inch increments	AVAILABLE DEPTHS in 2-inch increments
STARTER	SBDPJ3H (L x H x Base)	24 to 48 in.	48 to 96 in.	10 to 30 in.
* Example:	SBDPJ3H369624	36	96	24
ADDITION	SBBAPJ3H (L x H x Base)	24 to 48 in.	48 to 96 in.	10 to 30 in.
* Example:	SBBAPJ3H369624	36	96	24
BASE SHELF HEIGHT (2 heights available): 5 3/4 in. H <i>Low base</i> (from floor to shelf) 7 1/4 in. H <i>High base</i> (from floor to shelf)				

PERFORATED MASONITE BACK - KICKPLATE

	STRUCTURE CODE	AVAILABLE LENGTHS in 6-inch increments	AVAILABLE HEIGHTS in 6-inch increments	AVAILABLE DEPTHS in 2-inch increments
STARTER	SBDPP3H (L x H x Base)	24 to 48 in.	48 to 96 in.	10 to 30 in.
* Example:	SBDPP3H369624	36	96	24
ADDITION	SBBAPP3H (L x H x Base)	24 to 48 in.	48 to 96 in.	10 to 30 in.
* Example:	SBBAPP3H369624	36	96	24
BASE SHELF HEIGHT (2 heights available): 5 3/4 in. H <i>Low base</i> (from floor to shelf) 7 1/4 in. H <i>High base</i> (from floor to shelf)				

This is an example of coding based on the image above. Structure codes vary according to the size chosen.
See the **Accessories and Components** section for end caps

S SERIES - END CAP



EXAMPLE*:

36 in. long x 90 in. high island with a 22 in. deep base shelf

SLATWALL BACK - SHOE GUARD

	STRUCTURE CODE	AVAILABLE LENGTHS in 6-inch increments	AVAILABLE HEIGHTS in 6-inch increments	AVAILABLE DEPTHS in 2-inch increments
STARTER	-	24 to 48 in.	48 to 96 in.	10 to 30 in.
* Example:	-	36	96	24
ADDITION	-	24 to 48 in.	48 to 96 in.	10 to 30 in.
* Example:	-	36	96	24

BASE SHELF HEIGHT (2 heights available): 5 3/4 in. H *Low base* (from floor to shelf)
7 1/4 in. H *High base* (from floor to shelf)

SLATWALL BACK - KICKPLATE

	STRUCTURE CODE	AVAILABLE LENGTHS in 6-inch increments	AVAILABLE HEIGHTS in 6-inch increments	AVAILABLE DEPTHS in 2-inch increments
STARTER	SBSDIP3B (L x H x Base)	24 to 48 in.	48 to 96 in.	10 to 30 in.
* Example:	SBSDIP3B369024	36	96	24
ADDITION	SBSAIP3B (L x H x Base)	24 to 48 in.	48 to 96 in.	10 to 30 in.
* Example:	SBSAIP3B369024	36	96	24

BASE SHELF HEIGHT (2 heights available): 5 3/4 in. H *Low base* (from floor to shelf)
7 1/4 in. H *High base* (from floor to shelf)

This is an example of coding based on the image above. Structure codes vary according to the size chosen.
See the **Accessories and Components** section for end caps

C SERIES - WALL



DIMENSIONS

MEASURE (IN.)

AVAILABLE HEIGHTS 36 - 42 - 48 - 54 - 60 - 66 - 72

AVAILABLE WIDTHS 24 - 30 - 36 - 48

AVAILABLE BASE DEPTHS 8 - 10 - 12 - 14 - 16

AVAILABLE SHELF DEPTHS 8 - 10 - 12 - 14 - 16

OPTION: with or without shelves

BACK OPTION: masonite (plain or perforated), wire mesh and slatwall

C SERIES - ISLAND (END CAP AND PANEL OPTIONAL)



← Plain back island with base, slatwall panel and accessories (optional end cap or panel)

DIMENSIONS

MEASURE (IN.)

AVAILABLE HEIGHTS	36 - 42 - 48 - 54 - 60 - 66 - 72
AVAILABLE WIDTHS	24 - 30 - 36 - 48
AVAILABLE BASE DEPTHS	6 - 8 - 10 - 12 - 14 - 16
AVAILABLE SHELF DEPTHS	6 - 8 - 10 - 12 - 14 - 16

OPTION: with or without shelves

OPTION: on wheels or levelers

BACK OPTION: masonite (plain or perforated), wire mesh and slatwall

C SERIES - SEVERAL POSSIBLE CONFIGURATIONS



← Slatwall island with base, end cap and various accessories



→ Island with various backs, end caps and accessories

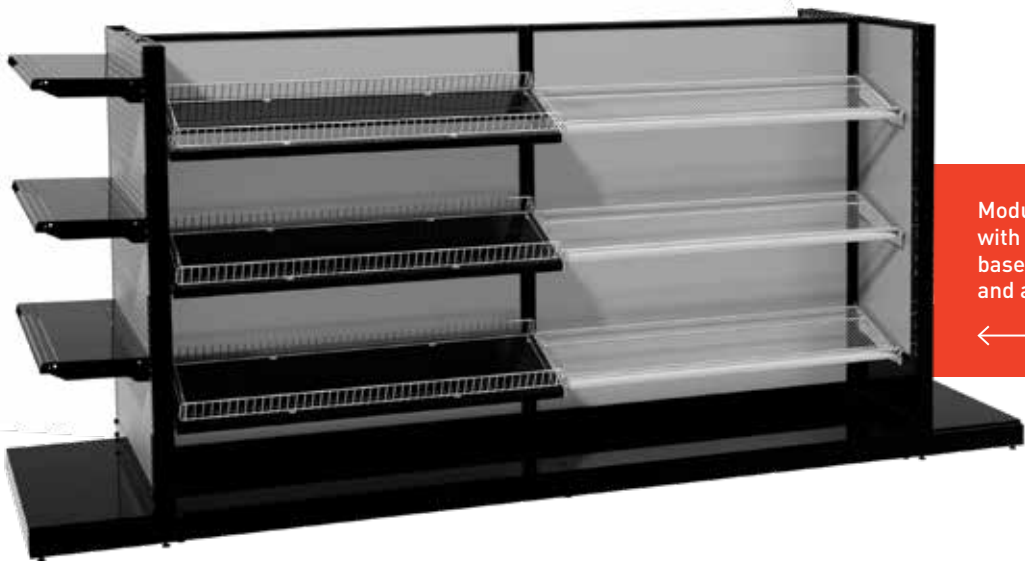

← Modular island with various backs, bases, island ends and accessories



IN THIS SECTION

E SERIES

S SERIES

C SERIES

COLD ROOMS

CIGARETTE CABINETS

RESERVES

COMMERCIAL RACKING SYSTEMS

GROCERY

E SERIES - WALL



PLAIN METAL BACK - SHOE GUARD

	STRUCTURE CODE	AVAILABLE LENGTHS in 6-inch increments	AVAILABLE HEIGHTS in 6-inch increments	AVAILABLE DEPTHS in 2-inch increments
STARTER	MDUJ (L x H x Base)	24 to 48 in.	48 to 120 in.	6 to 30 in.
* Example:	MDUJ368424	36	84	24
ADDITION	MAUJ (L x H x Base)	24 to 48 in.	48 to 120 in.	6 to 30 in.
* Example:	MAUJ368424	36	84	24

PLAIN METAL BACK - KICKPLATE

	STRUCTURE CODE	AVAILABLE LENGTHS in 6-inch increments	AVAILABLE HEIGHTS in 6-inch increments	AVAILABLE DEPTHS in 2-inch increments
STARTER	MDUP (L x H x Base)	24 to 48 in.	48 to 120 in.	6 to 30 in.
* Example:	MDUP368424	36	84	24
ADDITION	MAUP (L x H x Base)	24 to 48 in.	48 to 120 in.	6 to 30 in.
* Example:	MAUP368424	36	84	24

This is an example of coding based on the image above. Structure codes vary according to the size chosen.

E SERIES - WALL

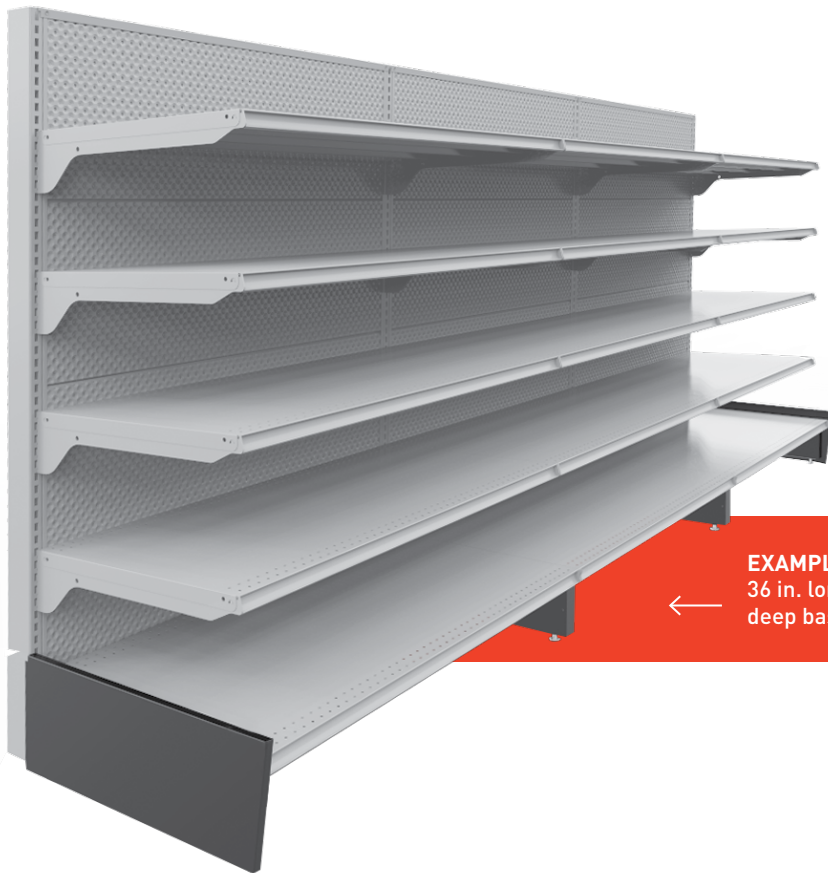

← **EXAMPLE*:**
36 in. long x 84 in. high wall with a 24 in.
deep base shelf

PERFORATED BACK - SHOE GUARD

	STRUCTURE CODE	AVAILABLE LENGTHS in 6-inch increments	AVAILABLE HEIGHTS in 6-inch increments	AVAILABLE DEPTHS in 2-inch increments
STARTER	MDPJ (L x H x Base)	24 to 48 in.	48 to 120 in.	6 to 30 in.
* Example:	MDPJ368424	36	84	24
ADDITION	MAPJ (L x H x Base)	24 to 48 in.	48 to 120 in.	6 to 30 in.
* Example:	MAPJ368424	36	84	24

PERFORATED BACK - KICKPLATE

	STRUCTURE CODE	AVAILABLE LENGTHS in 6-inch increments	AVAILABLE HEIGHTS in 6-inch increments	AVAILABLE DEPTHS in 2-inch increments
STARTER	MDPP (L x H x Base)	24 to 48 in.	48 to 120 in.	6 to 30 in.
* Example:	MDPP368424	36	84	24
ADDITION	MAPP (L x H x Base)	24 to 48 in.	48 to 120 in.	6 to 30 in.
* Example:	MAPP368424	36	84	24

This is an example of coding based on the image above. Structure codes vary according to the size chosen.

E SERIES - ISLAND



PLAIN METAL BACK - SHOE GUARD

	STRUCTURE CODE	AVAILABLE LENGTHS in 6-inch increments	AVAILABLE HEIGHTS in 6-inch increments	AVAILABLE DEPTHS in 2-inch increments
STARTER	IDUJ (L x H x Base)	24 to 48 in.	48 to 120 in.	6 to 30 in.
* Example:	IDUJ36842424	36	84	24
ADDITION	IAUJ (L x H x Base)	24 to 48 in.	48 to 120 in.	6 to 30 in.
* Example:	IAUJ36842424	36	84	24

PLAIN METAL BACK - KICKPLATE

	STRUCTURE CODE	AVAILABLE LENGTHS in 6-inch increments	AVAILABLE HEIGHTS in 6-inch increments	AVAILABLE DEPTHS in 2-inch increments
STARTER	IDUP (L x H x Base)	24 to 48 in.	48 to 120 in.	6 to 30 in.
* Example:	IDUP36842424	36	84	24
ADDITION	IAUP (L x H x Base)	24 to 48 in.	48 to 120 in.	6 to 30 in.
* Example:	IAUP36842424	36	84	24

This is an example of coding based on the image above. Structure codes vary according to the size chosen.

E SERIES - ISLAND



EXAMPLE*:

36 in. long x 84 in. high island with a 24 in. deep base shelf on each side

PERFORATED BACK- SHOE GUARD

	STRUCTURE CODE	AVAILABLE LENGTHS in 6-inch increments	AVAILABLE HEIGHTS in 6-inch increments	AVAILABLE DEPTHS in 2-inch increments
STARTER	IDPJ (L x H x Base)	24 to 48 in.	48 to 120 in.	6 to 30 in.
* Example:	IDPJ36842424	36	84	24
ADDITION	IAPJ (L x H x Base)	24 to 48 in.	48 to 120 in.	6 to 30 in.
* Example:	IAPJ36842424	36	84	24

PERFORATED BACK - KICKPLATE

	STRUCTURE CODE	AVAILABLE LENGTHS in 6-inch increments	AVAILABLE HEIGHTS in 6-inch increments	AVAILABLE DEPTHS in 2-inch increments
STARTER	IDPP (L x H x Base)	24 to 48 in.	48 to 120 in.	6 to 30 in.
* Example:	IDPP36842424	36	84	24
ADDITION	IAPP (L x H x Base)	24 to 48 in.	48 to 120 in.	6 to 30 in.
* Example:	IAPP36842424	36	84	24

This is an example of coding based on the image above. Structure codes vary according to the size chosen.

E SERIES - ISLAND



EXAMPLE*:

36 in. long x 84 in. high island with a 24 in. deep base shelf on each side

SLATWALL BACK - SHOE GUARD

	STRUCTURE CODE	AVAILABLE LENGTHS in 6-inch increments	AVAILABLE HEIGHTS in 6-inch increments	AVAILABLE DEPTHS in 2-inch increments
STARTER	-	24 to 48 in.	48 to 120 in.	6 to 30 in.
* Example:	-	36	84	24
ADDITION	-	24 to 48 in.	48 to 120 in.	6 to 30 in.
* Example:	-	36	84	24

SLATWALL BACK - KICKPLATE

	STRUCTURE CODE	AVAILABLE LENGTHS in 6-inch increments	AVAILABLE HEIGHTS in 6-inch increments	AVAILABLE DEPTHS in 2-inch increments
STARTER	-	24 to 48 in.	48 to 120 in.	6 to 30 in.
* Example:	-	36	84	24
ADDITION	-	24 to 48 in.	48 to 120 in.	6 to 30 in.
* Example:	-	36	84	24

This is an example of coding based on the image above. Structure codes vary according to the size chosen.

E SERIES - END CAP



EXAMPLE*:
36 in. long x 84 in. high island with
a 24 in. deep base shelf

PLAIN METAL BACK - SHOE GUARD

	STRUCTURE CODE	AVAILABLE LENGTHS in 6-inch increments	AVAILABLE HEIGHTS in 6-inch increments	AVAILABLE DEPTHS in 2-inch increments
STARTER	BDUJ (L x H x Base)	24 to 48 in.	48 to 120 in.	6 to 30 in.
* Example:	BDUJ368424	36	84	24
ADDITION	BAUJ (L x H x Base)	24 to 48 in.	48 to 120 in.	6 to 30 in.
* Example:	BAUJ368424	36	84	24

PLAIN METAL BACK - KICKPLATE

	STRUCTURE CODE	AVAILABLE LENGTHS in 6-inch increments	AVAILABLE HEIGHTS in 6-inch increments	AVAILABLE DEPTHS in 2-inch increments
STARTER	BDUP (L x H x Base)	24 to 48 in.	48 to 120 in.	6 to 30 in.
* Example:	BDUP368424	36	84	24
ADDITION	BAUP (L x H x Base)	24 to 48 in.	48 to 120 in.	6 to 30 in.
* Example:	BAUP368424	36	84	24

This is an example of coding based on the image above. Structure codes vary according to the size chosen.
See the **Accessories and Components** section for end caps

E SERIES - END CAP

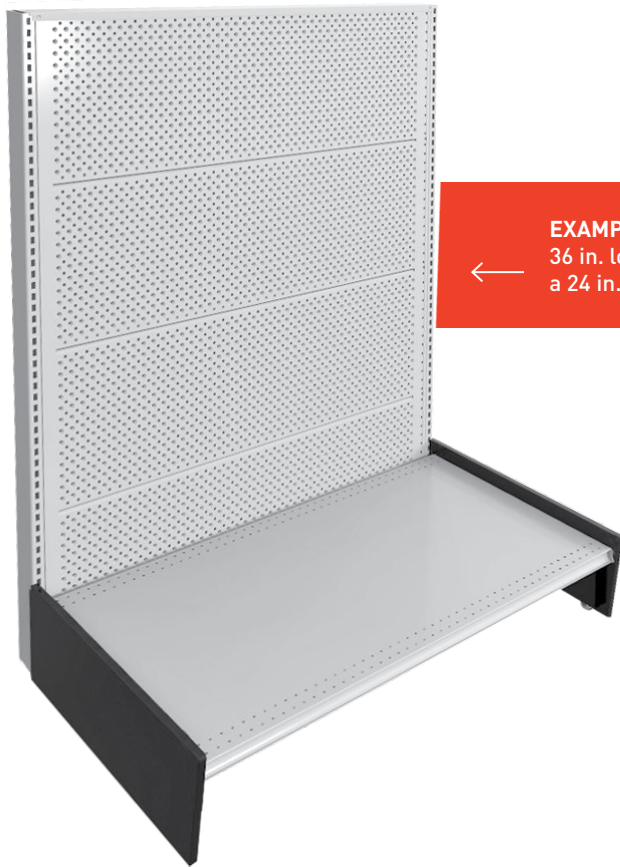

EXAMPLE*:
 ← 36 in. long x 84 in. high with
 a 24 in. deep base shelf

PERFORATED BACK - SHOE GUARD

	STRUCTURE CODE	AVAILABLE LENGTHS in 6-inch increments	AVAILABLE HEIGHTS in 6-inch increments	AVAILABLE DEPTHS in 2-inch increments
STARTER	BDPJ (L x H x Base)	24 to 48 in.	48 to 120 in.	6 to 30 in.
* Example:	BDPJ368424	36	84	24
ADDITION	BAPJ (L x H x Base)	24 to 48 in.	48 to 120 in.	6 to 30 in.
* Example:	BAPJ368424	36	84	24

PERFORATED BACK - KICKPLATE

	STRUCTURE CODE	AVAILABLE LENGTHS in 6-inch increments	AVAILABLE HEIGHTS in 6-inch increments	AVAILABLE DEPTHS in 2-inch increments
STARTER	BDPP (L x H x Base)	24 to 48 in.	48 to 120 in.	6 to 30 in.
* Example:	BDPP368424	36	84	24
ADDITION	BAPP (L x H x Base)	24 to 48 in.	48 to 120 in.	6 to 30 in.
* Example:	BAPP368424	36	84	24

This is an example of coding based on the image above. Structure codes vary according to the size chosen.
 See the **Accessories and Components** section for end caps

E SERIES - END CAP



EXAMPLE*:
 ← 36 in. long x 84 in. high with
 a 24 in. deep base shelf

SLATWALL BACK - SHOE GUARD

	STRUCTURE CODE	AVAILABLE LENGTHS in 6-inch increments	AVAILABLE HEIGHTS in 6-inch increments	AVAILABLE DEPTHS in 2-inch increments
STARTER	-	24 to 48 in.	48 to 120 in.	6 to 30 in.
* Example:	-	36	84	24
ADDITION	-	24 to 48 in.	48 to 120 in.	6 to 30 in.
* Example:	-	36	84	24

SLATWALL BACK - KICKPLATE

	STRUCTURE CODE	AVAILABLE LENGTHS in 6-inch increments	AVAILABLE HEIGHTS in 6-inch increments	AVAILABLE DEPTHS in 2-inch increments
STARTER	-	24 to 48 in.	48 to 120 in.	6 to 30 in.
* Example:	-	36	84	24
ADDITION	-	24 to 48 in.	48 to 120 in.	6 to 30 in.
* Example:	-	36	84	24

This is an example of coding based on the image above. Structure codes vary according to the size chosen.
 See the **Accessories and Components** section for end caps

S SERIES - WALL



EXAMPLE*:
36 in. long x 84 in. high wall with
a 24 in. deep base shelf

DOS MASSONITE UNI - SHOE GUARD

	STRUCTURE CODE	AVAILABLE LENGTHS in 6-inch increments	AVAILABLE HEIGHTS in 6-inch increments	AVAILABLE DEPTHS in 2-inch increments
STARTER	SMBDUJ3B (L x H x Base)	24 to 48 in.	48 to 120 in.	6 to 30 in.
* Example:	SMBDUJ3B368424	36	84	24
ADDITION	SMBAUJ3B (L x H x Base)	24 to 48 in.	48 to 120 in.	6 to 30 in.
* Example:	SMBAUJ3B368424	36	84	24
BASE SHELF HEIGHT (2 heights available): 5 3/4 in. H <i>Low base</i> (from floor to shelf) 7 1/4 in. H <i>High base</i> (from floor to shelf)				

SOLID MASONITE BACK - KICKPLATE

	STRUCTURE CODE	AVAILABLE LENGTHS in 6-inch increments	AVAILABLE HEIGHTS in 6-inch increments	AVAILABLE DEPTHS in 2-inch increments
STARTER	SMBDPJ3B (L x H x Base)	24 to 48 in.	48 to 120 in.	6 to 30 in.
* Example:	SMBDPJ3B368424	36	84	24
ADDITION	SMBAUP3B (L x H x Base)	24 to 48 in.	48 to 120 in.	6 to 30 in.
* Example:	SMBAUP3B368424	36	84	24
BASE SHELF HEIGHT (2 heights available): 5 3/4 in. H <i>Low base</i> (from floor to shelf) 7 1/4 in. H <i>High base</i> (from floor to shelf)				

This is an example of coding based on the image above. Structure codes vary according to the size chosen.

S SERIES - WALL

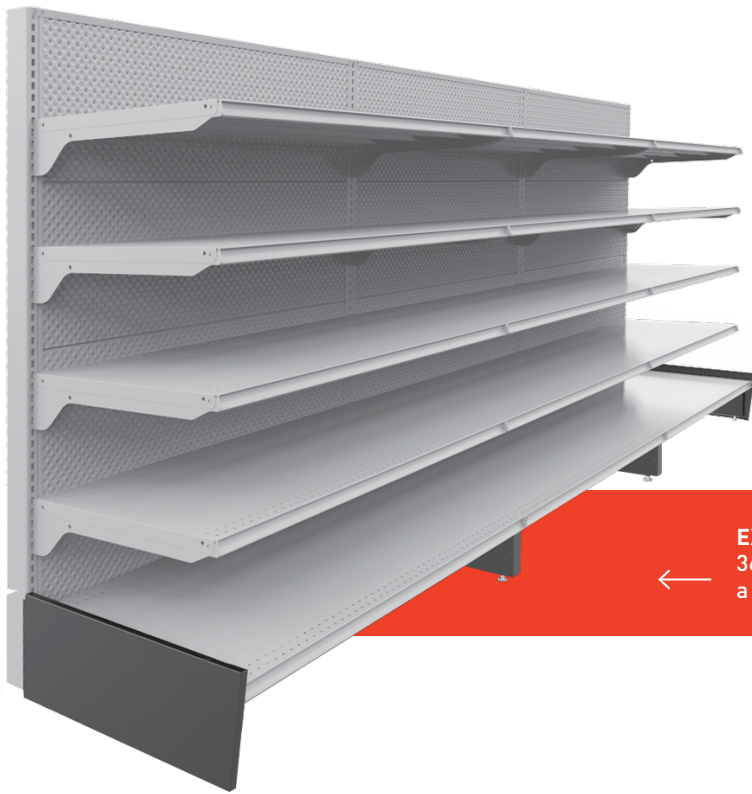

EXAMPLE*:
36 in. long x 84 in. high wall with
a 24 in. deep base shelf

PERFORATED MASONITE BACK - SHOE GUARD

	STRUCTURE CODE	AVAILABLE LENGTHS in 6-inch increments	AVAILABLE HEIGHTS in 6-inch increments	AVAILABLE DEPTHS in 2-inch increments
STARTER	SMBDPJ3B (L x H x Base)	24 to 48 in.	48 to 120 in.	6 to 30 in.
* Example:	SMBDPJ3B368424	36	84	24
ADDITION	SMBAPJ3B (L x H x Base)	24 to 48 in.	48 to 120 in.	6 to 30 in.
* Example:	SMBAPJ3B368424	36	84	24
BASE SHELF HEIGHT (2 heights available): 5 3/4 in. H <i>Low base</i> (from floor to shelf) 7 1/4 in. H <i>High base</i> (from floor to shelf)				

PERFORATED MASONITE BACK - KICKPLATE

	STRUCTURE CODE	AVAILABLE LENGTHS in 6-inch increments	AVAILABLE HEIGHTS in 6-inch increments	AVAILABLE DEPTHS in 2-inch increments
STARTER	SMBDPP3B (L x H x Base)	24 to 48 in.	48 to 96 in.	10 to 30 in.
* Example:	SMBDPP3B368424	36	84	24
ADDITION	SMBAPP3B (L x H x Base)	24 to 48 in.	48 to 96 in.	10 to 30 in.
* Example:	SMBAPP3B368424	36	84	24
BASE SHELF HEIGHT (2 heights available): 5 3/4 in. H <i>Low base</i> (from floor to shelf) 7 1/4 in. H <i>High base</i> (from floor to shelf)				

This is an example of coding based on the image above. Structure codes vary according to the size chosen.

S SERIES - WALL



EXAMPLE*:
36 in. long x 84 in. high wall with
a 24 in. deep base shelf

SLATWALL BACK - SHOE GUARD

	STRUCTURE CODE	AVAILABLE LENGTHS in 6-inch increments	AVAILABLE HEIGHTS in 6-inch increments	AVAILABLE DEPTHS in 2-inch increments
STARTER	-	24 to 48 in.	48 to 120 in.	6 to 30 in.
* Example:	-	36	84	24
ADDITION	-	24 to 48 in.	48 to 120 in.	6 to 30 in.
* Example:	-	36	84	24
BASE SHELF HEIGHT (2 heights available): 5 3/4 in. H <i>Low base</i> (from floor to shelf) 7 1/4 in. H <i>High base</i> (from floor to shelf)				

SLATWALL BACK - KICKPLATE

	STRUCTURE CODE	AVAILABLE LENGTHS in 6-inch increments	AVAILABLE HEIGHTS in 6-inch increments	AVAILABLE DEPTHS in 2-inch increments
STARTER	SMSDIP3B (L x H x Base)	24 to 48 in.	48 to 96 in.	10 to 30 in.
* Example:	SMSDIP3B36842424B	36	84	24
ADDITION	SMSAIP3B (L x H x Base)	24 to 48 in.	48 to 96 in.	10 to 30 in.
* Example:	SMSAIP3B36842424B	36	84	24
BASE SHELF HEIGHT (2 heights available): 5 3/4 in. H <i>Low base</i> (from floor to shelf) 7 1/4 in. H <i>High base</i> (from floor to shelf)				

This is an example of coding based on the image above. Structure codes vary according to the size chosen.

S SERIES - ISLAND

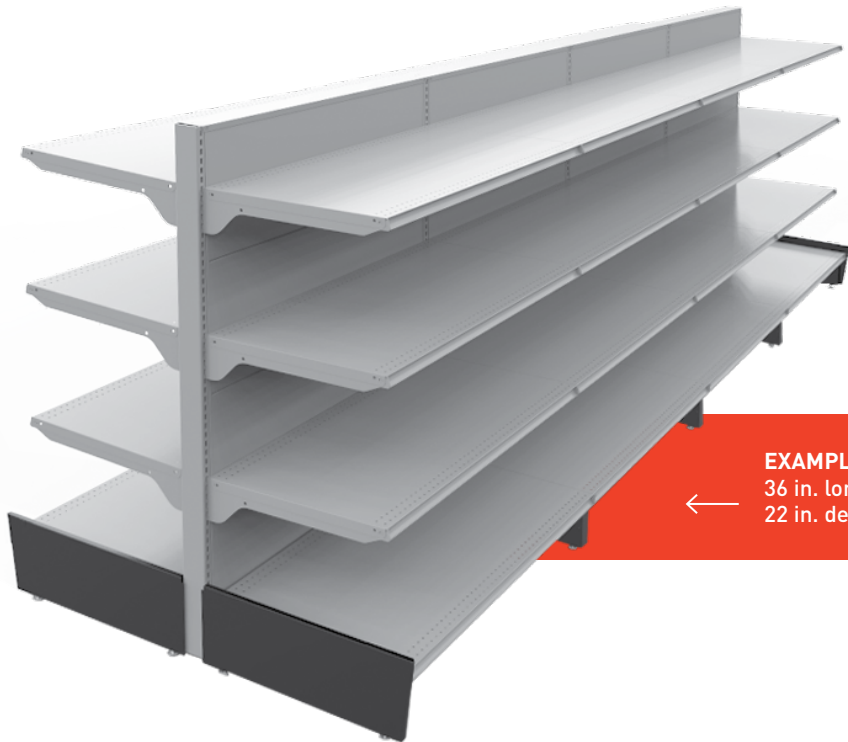

EXAMPLE*:

36 in. long x 84 in. high island with a 22 in. deep base shelf on each side

SOLID MASONITE BACK - SHOE GUARD

	STRUCTURE CODE	AVAILABLE LENGTHS in 6-inch increments	AVAILABLE HEIGHTS in 6-inch increments	AVAILABLE DEPTHS in 2-inch increments
STARTER	SIBDUJ3B (L x H x Base)	24 to 48 in.	48 to 120 in.	6 to 30 in.
* Example:	SIBDUJ3B36842222	36	84	22
ADDITION	SIBAUJ3B (L x H x Base)	24 to 48 in.	48 to 120 in.	6 to 30 in.
* Example:	SIBAUJ3B36842222	36	84	22
BASE SHELF HEIGHT (2 heights available): 5 3/4 in. H <i>Low base</i> (from floor to shelf) 7 1/4 in. H <i>High base</i> (from floor to shelf)				

SOLID MASONITE BACK - KICKPLATE

	STRUCTURE CODE	AVAILABLE LENGTHS in 6-inch increments	AVAILABLE HEIGHTS in 6-inch increments	AVAILABLE DEPTHS in 2-inch increments
STARTER	SIBDUP3B (L x H x Base)	24 to 48 in.	48 to 96 in.	10 to 30 in.
* Example:	SIBDUP3B36842222	36	84	22
ADDITION	SIBAUP3B (L x H x Base)	24 to 48 in.	48 to 96 in.	10 to 30 in.
* Example:	SIBAUP3B36842222	36	84	22
BASE SHELF HEIGHT (2 heights available): 5 3/4 in. H <i>Low base</i> (from floor to shelf) 7 1/4 in. H <i>High base</i> (from floor to shelf)				

This is an example of coding based on the image above. Structure codes vary according to the size chosen.

S SERIES - ISLAND

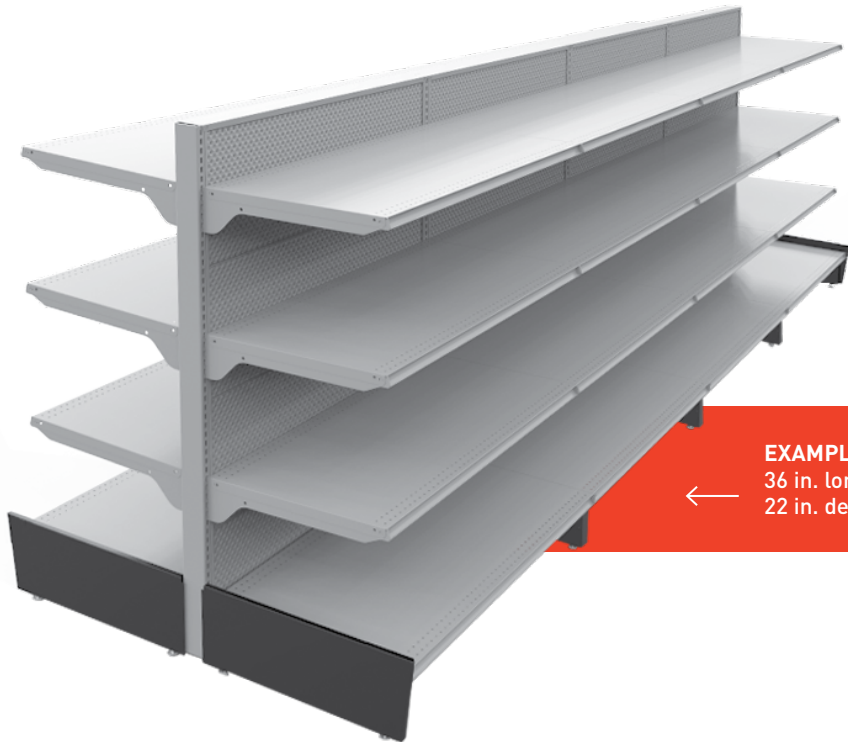

EXAMPLE*:

36 in. long x 84 in. high island with a 22 in. deep base shelf on each side

PERFORATED MASONITE BACK - SHOE GUARD

	STRUCTURE CODE	AVAILABLE LENGTHS in 6-inch increments	AVAILABLE HEIGHTS in 6-inch increments	AVAILABLE DEPTHS in 2-inch increments
STARTER	SIBDPJ3B (L x H x Base)	24 to 48 in.	48 to 96 in.	10 to 30 in.
* Example:	SIBDPJ3B36842222	36	84	22
ADDITION	SIBAPJ3B (L x H x Base)	24 to 48 in.	48 to 96 in.	10 to 30 in.
* Example:	SIBAPJ3B36842222	36	84	22
BASE SHELF HEIGHT (2 heights available): 5 3/4 in. H <i>Low base</i> (from floor to shelf) 7 1/4 in. H <i>High base</i> (from floor to shelf)				

PERFORATED MASONITE BACK - KICKPLATE

	STRUCTURE CODE	AVAILABLE LENGTHS in 6-inch increments	AVAILABLE HEIGHTS in 6-inch increments	AVAILABLE DEPTHS in 2-inch increments
STARTER	SIBDPP3B (L x H x Base)	24 to 48 in.	48 to 96 in.	10 to 30 in.
* Example:	SIBDPP3B36842222	36	84	22
ADDITION	SIBAPP3B (L x H x Base)	24 to 48 in.	48 to 96 in.	10 to 30 in.
* Example:	SIBAPP3B36842222	36	84	22
BASE SHELF HEIGHT (2 heights available): 5 3/4 in. H <i>Low base</i> (from floor to shelf) 7 1/4 in. H <i>High base</i> (from floor to shelf)				

This is an example of coding based on the image above. Structure codes vary according to the size chosen.

S SERIES - ISLAND



← **EXAMPLE*:**
36 in. long x 84 in. high island with a
24 in. deep base shelf on each side

SLATWALL BACK - KICKPLATE

	STRUCTURE CODE	AVAILABLE LENGTHS in 6-inch increments	AVAILABLE HEIGHTS in 6-inch increments	AVAILABLE DEPTHS in 2-inch increments
STARTER	SISDIP3B (L x H x Base)	24 to 48 in.	48 to 96 in.	10 to 30 in.
* Example:	SISDIP3B36842424B	36	84	24
ADDITION	SISAIP3B (L x H x Base)	24 to 48 in.	48 to 96 in.	10 to 30 in.
* Example:	SISAIP3B36842424B	36	84	24
BASE SHELF HEIGHT (2 heights available): 5 3/4 in. H <i>Low base</i> (from floor to shelf) 7 1/4 in. H <i>High base</i> (from floor to shelf)				

This is an example of coding based on the image above. Structure codes vary according to the size chosen.

S SERIES - END CAP



EXAMPLE*:

36 in. long x 96 in. high island with
a 22 in. deep base shelf

SOLID MASONITE BACK - SHOE GUARD

	STRUCTURE CODE	AVAILABLE LENGTHS in 6-inch increments	AVAILABLE HEIGHTS in 6-inch increments	AVAILABLE DEPTHS in 2-inch increments
STARTER	SBBDUJ3H (L x H x Base)	24 to 48 in.	48 to 96 in.	10 to 30 in.
* Example:	SBBDUJ3H369624	36	96	24
ADDITION	SBBAUJ3H (L x H x Base)	24 to 48 in.	48 to 96 in.	10 to 30 in.
* Example:	SBBAUJ3H369624	36	96	24
BASE SHELF HEIGHT (2 heights available): 5 3/4 in. H <i>Low base</i> (from floor to shelf) 7 1/4 in. H <i>High base</i> (from floor to shelf)				

SOLID MASONITE BACK - KICKPLATE

	STRUCTURE CODE	AVAILABLE LENGTHS in 6-inch increments	AVAILABLE HEIGHTS in 6-inch increments	AVAILABLE DEPTHS in 2-inch increments
STARTER	SBBDUP3H (L x H x Base)	24 to 48 in.	48 to 96 in.	10 to 30 in.
* Example:	SBBDUP3H369624	36	96	24
ADDITION	SBBAUP3H (L x H x Base)	24 to 48 in.	48 to 96 in.	10 to 30 in.
* Example:	SBBAUP3H369624	36	96	24
BASE SHELF HEIGHT (2 heights available): 5 3/4 in. H <i>Low base</i> (from floor to shelf) 7 1/4 in. H <i>High base</i> (from floor to shelf)				

This is an example of coding based on the image above. Structure codes vary according to the size chosen.
See the **Accessories and Components** section for end caps

S SERIES - END CAP

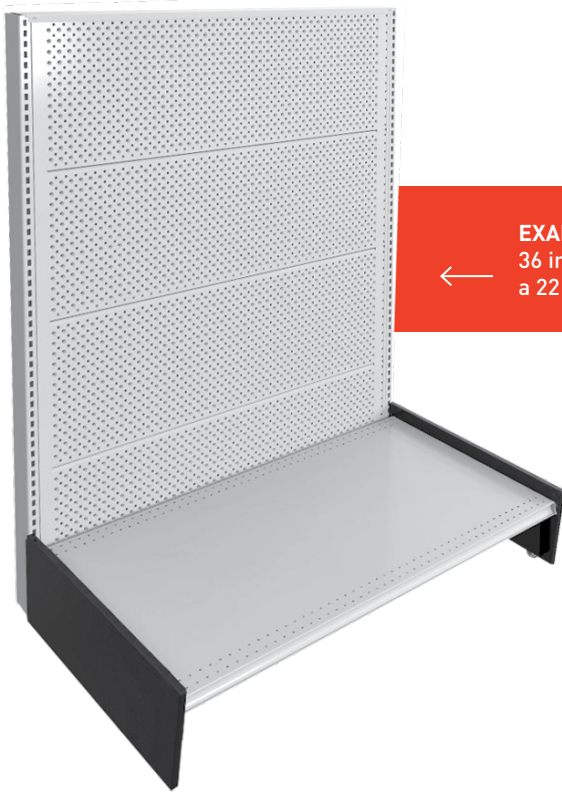

EXAMPLE*:
 ← 36 in. long x 96 in. high island with a 22 in. deep base shelf

PERFORATED MASONITE BACK - SHOE GUARD

	STRUCTURE CODE	AVAILABLE LENGTHS in 6-inch increments	AVAILABLE HEIGHTS in 6-inch increments	AVAILABLE DEPTHS in 2-inch increments
STARTER	SBDPJ3H (L x H x Base)	24 to 48 in.	48 to 96 in.	10 to 30 in.
* Example:	SBDPJ3H369624	36	96	24
ADDITION	SBBAPJ3H (L x H x Base)	24 to 48 in.	48 to 96 in.	10 to 30 in.
* Example:	SBBAPJ3H369624	36	96	24
BASE SHELF HEIGHT (2 heights available): 5 3/4 in. H <i>Low base</i> (from floor to shelf) 7 1/4 in. H <i>High base</i> (from floor to shelf)				

PERFORATED MASONITE BACK - KICKPLATE

	STRUCTURE CODE	AVAILABLE LENGTHS in 6-inch increments	AVAILABLE HEIGHTS in 6-inch increments	AVAILABLE DEPTHS in 2-inch increments
STARTER	SBDPP3H (L x H x Base)	24 to 48 in.	48 to 96 in.	10 to 30 in.
* Example:	SBDPP3H369624	36	96	24
ADDITION	SBBAPP3H (L x H x Base)	24 to 48 in.	48 to 96 in.	10 to 30 in.
* Example:	SBBAPP3H369624	36	96	24
BASE SHELF HEIGHT (2 heights available): 5 3/4 in. H <i>Low base</i> (from floor to shelf) 7 1/4 in. H <i>High base</i> (from floor to shelf)				

*This is an example of coding based on the image above. Structure codes vary according to the size chosen. See the **Accessories and Components** section for end caps*

S SERIES - END CAP



EXAMPLE*:
 ← 36 in. long x 90 in. high island with a 22 in. deep base shelf

SLATWALL BACK - SHOE GUARD

	STRUCTURE CODE	AVAILABLE LENGTHS in 6-inch increments	AVAILABLE HEIGHTS in 6-inch increments	AVAILABLE DEPTHS in 2-inch increments
STARTER	-	24 to 48 in.	48 to 96 in.	10 to 30 in.
* Example:	-	36	96	24
ADDITION	-	24 to 48 in.	48 to 96 in.	10 to 30 in.
* Example:	-	36	96	24

BASE SHELF HEIGHT (2 heights available): 5 3/4 in. H *Low base* (from floor to shelf)
 7 1/4 in. H *High base* (from floor to shelf)

SLATWALL BACK - KICKPLATE

	STRUCTURE CODE	AVAILABLE LENGTHS in 6-inch increments	AVAILABLE HEIGHTS in 6-inch increments	AVAILABLE DEPTHS in 2-inch increments
STARTER	SBSDIP3B (L x H x Base)	24 to 48 in.	48 to 96 in.	10 to 30 in.
* Example:	SBSDIP3B369024	36	96	24
ADDITION	SBSAIP3B (L x H x Base)	24 to 48 in.	48 to 96 in.	10 to 30 in.
* Example:	SBSAIP3B369024	36	96	24

BASE SHELF HEIGHT (2 heights available): 5 3/4 in. H *Low base* (from floor to shelf)
 7 1/4 in. H *High base* (from floor to shelf)

This is an example of coding based on the image above. Structure codes vary according to the size chosen.
 See the **Accessories and Components** section for end caps

C SERIES - WALL



DIMENSIONS

MEASURE (IN.)

AVAILABLE HEIGHTS 36 - 42 - 48 - 54 - 60 - 66 - 72

AVAILABLE WIDTHS 24 - 30 - 36 - 48

AVAILABLE BASE DEPTHS 8 - 10 - 12 - 14 - 16

AVAILABLE SHELF DEPTHS 8 - 10 - 12 - 14 - 16

OPTION: with or without shelves

BACK OPTION: masonite (plain or perforated), wire mesh and slatwall

C SERIES - ISLAND (END CAP AND PANEL OPTIONAL)



← Plain back island with base, slatwall panel and accessories (optional end cap or panel)

DIMENSIONS	MEASURE (IN.)
AVAILABLE HEIGHTS	36 - 42 - 48 - 54 - 60 - 66 - 72
AVAILABLE WIDTHS	24 - 30 - 36 - 48
AVAILABLE BASE DEPTHS	6 - 8 - 10 - 12 - 14 - 16
AVAILABLE SHELF DEPTHS	6 - 8 - 10 - 12 - 14 - 16

OPTION: with or without shelves

OPTION: on wheels or levelers

BACK OPTION: masonite (plain or perforated), wire mesh and slatwall

C SERIES - SEVERAL POSSIBLE CONFIGURATIONS



← Slatwall island with base, end cap and various accessories



→ Island with various backs, end caps and accessories

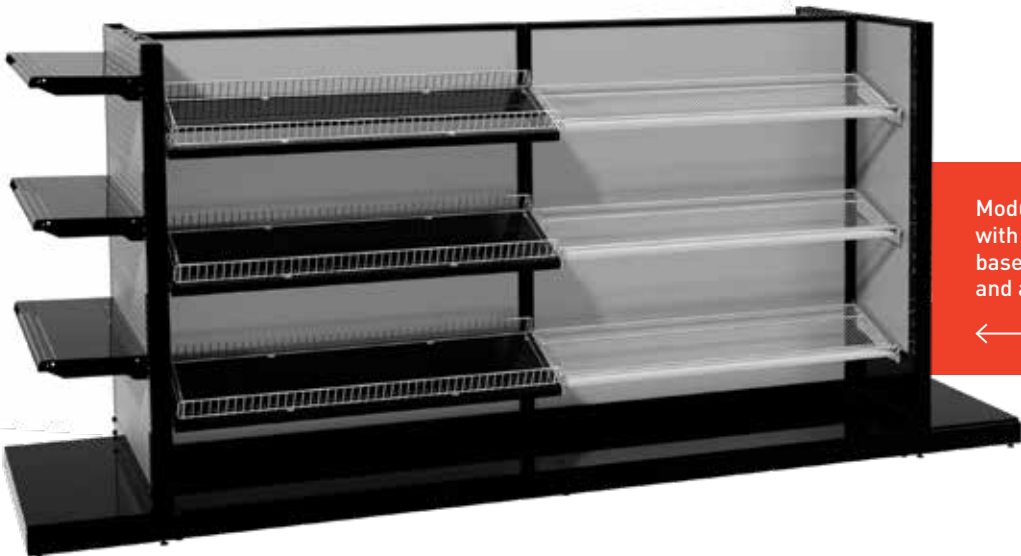

← Modular island with various backs, bases, island ends and accessories

PROFIT PANEL

PROFIT PANEL

SB CODE	MEASURE (IN.)	
P0207145410	14 L x 54 H x 10 D	4 shelves
P0207195410	19 L x 54 H x 10 D	4 shelves
P0207196110	19 L x 61 H x 10 D	5 shelves
P0207245410	24 L x 54 H x 10 D	4 shelves
P0207246010	24 L x 60 H x 10 D	4 shelves
P0207247210	24 L x 72 H x 10 D	6 shelves
P0207247810	24 L x 78 H x 10 D	6 shelves
P0207248410	24 L x 84 H x 10 D	6 shelves
P0207249010	24 L x 90 H x 10 D	6 shelves
P0207265410 (4T)	26 L x 54 H x 10 D	4 shelves
P0207266010 (4T)	26 L x 60 H x 10 D	4 shelves
P0207267210 (6T)	26 L x 72 H x 10 D	6 shelves
P0207267810 (6T)	26 L x 78 H x 10 D	6 shelves
P0207268410 (6T)	26 L x 84 H x 10 D	6 shelves
P0207269010 (6T)	26 L x 90 H x 10 D	6 shelves
P0207269010 (7T)	26 L x 90 H x 10 D	7 shelves

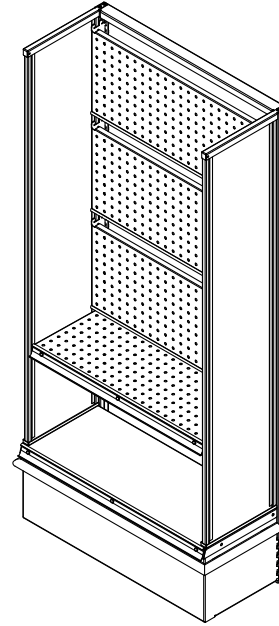

SHELF FOR PROFIT PANEL

SB CODE	MEASURE (IN.)
003670913	14 L x 10 D
003670918	19 L x 10 D
003670923	24 L x 10 D
003670925	26 L x 10 D

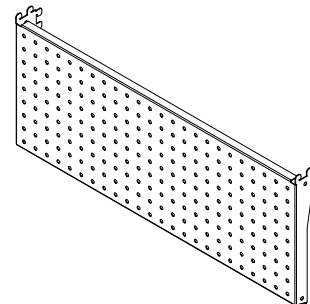
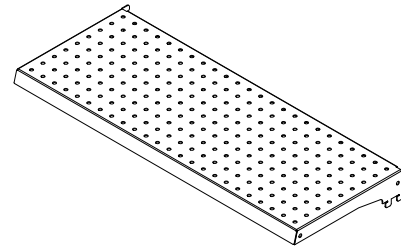

COLD ROOM: PRODUCTS



STAINLESS STEEL WALL



GALVANIZED WALL



OMEGA WALL



BACKLESS WALL

COLD ROOM: STAINLESS WALL

UPRIGHT AND EXTENSION

SB CODE	MEASURE (IN.)
PST-00-0008	96 (upright 92 + extension 9)
PST-00-0009	108 (upright 92 + extension 22)
PST-00-0010	120 (upright 92 + extension 34)

OPENSLAT SHELF WITH BRACKETS

2 BRACKETS INCLUDED

SB CODE	MEASURE (IN.)
026-CS-3012	12 x 30 L
026-CS-3018	18 x 30 L
026-CS-3024	24 x 30 L
026-CS-3612	12 x 36 L
026-CS-3618	18 x 36 L
026-CS-3624	24 x 36 L
026-CS-4812	12 x 46 1/2 L
026-CS-4818	18 x 46 1/2 L
026-CS-4824	24 x 46 1/2 L

BRACKETS

SB CODE	MEASURE (IN.)	
026-04-0012	12	Right - for 3 shelves
026-04-0018	18	Right - for 4 shelves
026-04-0024	24	Right - for 6 shelves
026-04-0112	12	Left - for 3 shelves
026-04-0118	18	Left - for 4 shelves
026-04-0124	24	Left - for 6 shelves

SHELF

SB CODE	MEASURE (IN.)
026-03-0024	2 1/4 x 24 L
026-03-0030	2 1/4 x 30 L
026-03-0036	2 1/4 x 36 L
026-03-0048	2 1/4 x 46 1/2 L

OPENSLAT BASE

SB CODE	MEASURE (IN.)
BAI-00-3624	24 x 36 L
BAI-00-2448	24 x 46 1/2 L

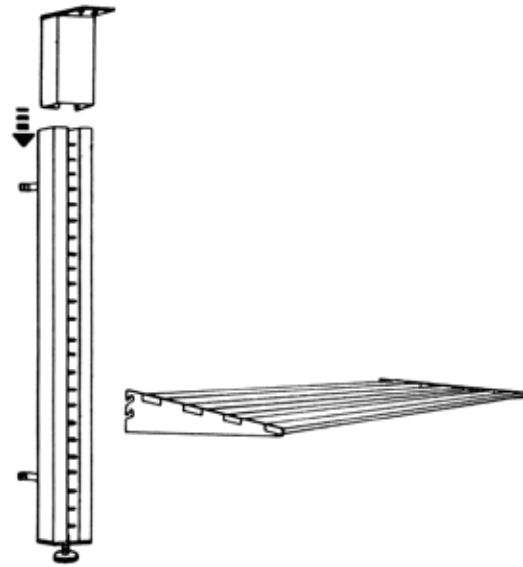

STAINLESS STEEL ACCESSORIES

STARTER GALVANIZED UPRIGHT AND EXTENSIONS

ANJOU CODE	MEASURE (IN.)	
P01070084	Starter upright 7 ft.	2 uprights 80 3/8 in. 2 extensions 9 in. 6 brackets 1 1/4 in.
P01070090	Starter upright 7 ft. 6 in.	2 uprights 83 1/4 in. 2 extensions 12 in. 6 brackets 1 1/4 in.
P01070096	Starter upright 8 ft.	2 uprights 89 1/4 in. 2 extensions 12 in. 6 brackets 1 1/4 in.
P01070102	Starter upright 8 ft. 6 in.	2 uprights 89 1/4 in. 2 extensions 16 in. 6 brackets 1 1/4 in.
P01070108	Starter upright 9 ft.	2 uprights 89 1/4 in. 2 extensions 28 in. 6 brackets 1 1/4 in.

Other dimensions available on request

ADD-ON GALVANIZED UPRIGHT AND EXTENSIONS

ANJOU CODE	MEASURE (IN.)	
P11070084	Add-on upright 7 ft.	2 uprights 80 3/8 in. 2 extensions 9 in. 6 brackets 1 1/4 in.
P11070090	Add-on upright 7 ft. 6 in.	2 uprights 83 1/4 in. 2 extensions 12 in. 6 brackets 1 1/4 in.
P11070096	Add-on upright 8 ft.	2 uprights x 89 1/4 in. 2 extensions 12 in. 6 brackets 1 1/4 in.
P11070102	Add-on upright 8 ft. 6 in.	2 uprights x 89 1/4 in. 2 extensions 16 in. 6 brackets 1 1/4 in.
P11070108	Add-on upright 9 ft.	2 uprights x 89 1/4 in. 2 extensions 28 in. 6 brackets 1 1/4 in.

Other dimensions available on request



STAINLESS STEEL ACCESSORIES

OPENSLAT SHELVES WITH BRACKETS

ANJOU CODE	MEASURE (IN.)
TSS001224	12 x 24
TSS001230	12 x 30
TSS001236	12 x 36
TSS001242	12 x 42
TSS001248	12 x 46 1/2
TSS001824	18 x 24
TSS001830	18 x 30
TSS001836	18 x 36
TSS001842	18 x 42
TSS001848	18 x 46 1/2
TSS002424	24 x 24
TSS002430	24 x 30
TSS002436	24 x 36
TSS002442	24 x 42
TSS002448	24 x 46 1/2

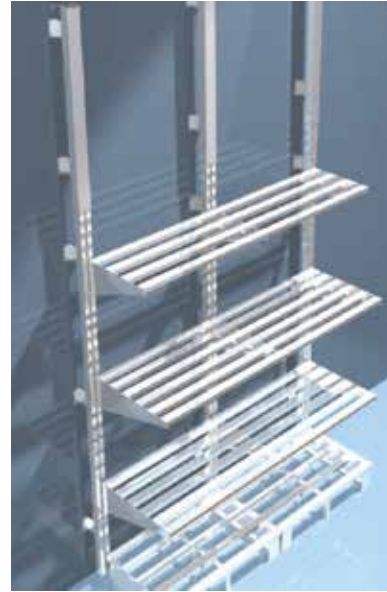

BRACKET

ANJOU CODE	MEASURE (IN.)	
018020013	13	Right
018020018	18	Right
018020024	24	Right
018020113	13	Left
018020118	18	Left
018020124	24	Left

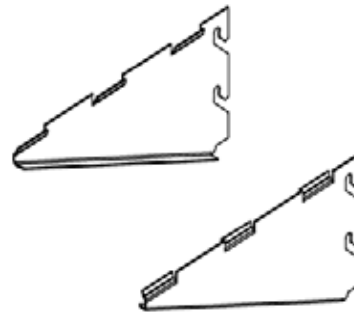

REMOVABLE SLAT

ANJOU CODE	MEASURE (IN.)
018010024	2 1/4 x 24 L
018010030	2 1/4 x 30 L
018010036	2 1/4 x 36 L
018010042	2 1/4 x 42 L
018010048	2 1/4 x 46 1/4 L

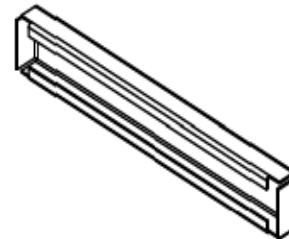

PLATFORM

ANJOU CODE	MEASURE (IN.)
B18001836	18 x 36
B18001848	18 x 48
B18002436	24 x 36
B18002448	24 x 46 1/4



GALVANIZED / STAINLESS STEEL ACCESSORIES

OPENSLAT SHELF WITH BRACKETS

6 in. STAINLESS STEEL SHELVES, GALVANIZED BRACKETS

ANJOU CODE	MEASURE (IN.)
TSG001224	12 x 24
TSG001230	12 x 30
TSG001236	12 x 36
TSG001248	12 x 48
TSG001824	18 x 24
TSG001830	18 x 30
TSG001836	18 x 36
TSG001848	18 x 48
TSG002424	24 x 24
TSG002430	24 x 30
TSG002436	24 x 36
TSG002448	24 x 48



GALVANIZED BRACKET

ANJOU CODE	MEASURE (IN.)	
018060012	12	Right - for 2 shelves
018060018	18	Right - for 3 shelves
018060024	24	Right - for 4 shelves
018060112	12	Left - for 2 shelves
018060118	18	Left - for 3 shelves
018060124	24	Left - for 4 shelves

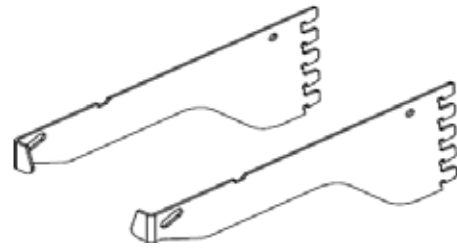

20GA STAINLESS SHELF

ANJOU CODE	MEASURE (IN.)
018010624	6 x 24
018010630	6 x 30
018010636	6 x 36
018010648	6 x 48

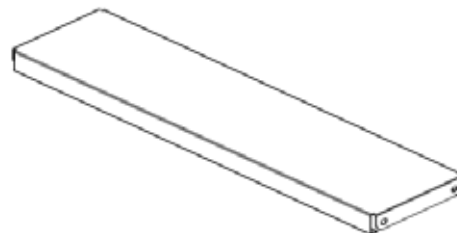

COLD ROOM: GALVANIZED WALL

UPRIGHT, EXTENSION AND 3 ANCHORS

SB CODE	MEASURE (IN.)
027-01-0092	90 5/8

UPRIGHT EXTENSION

SB CODE	MEASURE (IN.)
027-02-0009	9
027-02-0016	16
027-02-0022	22
027-02-0028	28
027-02-0034	34

WALL BRACKET

SB CODE	MEASURE (IN.)
027-00-0000	1 1/4

SHELF WITH BRACKETS

SB CODE	MEASURE (IN.)
027-05-3012	12 x 30 L
027-05-3018	18 x 30 L
027-05-3024	24 x 30 L
027-05-3612	12 x 36 L
027-05-3618	18 x 36 L
027-05-3624	24 x 36 L
027-05-4812	12 x 48 L
027-05-4818	18 x 48 L
027-05-4824	24 x 48 L

BRACKET

SB CODE	MEASURE (IN.)	
027-04-0012	12	Right
027-04-0018	18	Right
027-04-0024	24	Right
027-04-0112	12	Left
027-04-0118	18	Left
027-04-0124	24	Left

SHELF

SB CODE	MEASURE (IN.)
027-03-0024	6 x 24 L
027-03-0030	6 x 30 L
027-03-0036	6 x 36 L
027-03-0048	6 x 48 L

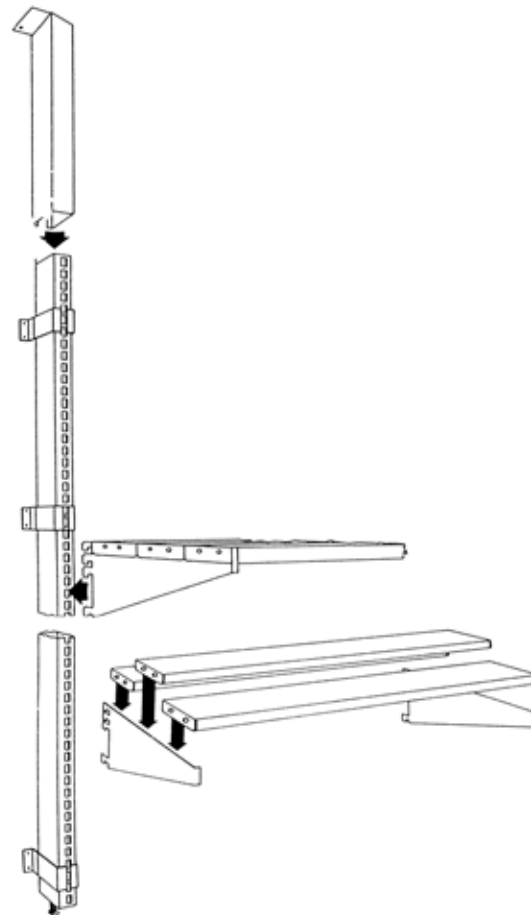

GALVANIZED STEEL ACCESSORIES

STARTER GALVANIZED UPRIGHTS AND EXTENSIONS

ANJOU CODE	MEASURE (IN.)	
P01080084	Starter upright 7 ft.	2 uprights 80 3/8 in. 2 extensions 9 in. 6 brackets 1 1/4 in.
P01080090	Starter upright 7 ft. 6 in.	2 uprights 83 1/4 in. 2 extensions 12 in. 6 brackets 1 1/4 in.
P01080096	Starter upright 8 ft.	2 uprights 89 1/4 in. 2 extensions 12 in. 6 brackets 1 1/4 in.
P01080102	Starter upright 8 ft. 6 in.	2 uprights 89 1/4 in. 2 extensions 16 in. 6 brackets 1 1/4 in.
P01080108	Starter upright 9 ft.	2 uprights 89 1/4 in. 2 extensions 28 in. 6 brackets 1 1/4 in.

Other dimensions available on request

ADD-ON GALVANIZED UPRIGHTS AND EXTENSIONS

ANJOU CODE	MEASURE (IN.)	
P11080084	Add-on upright 7 ft.	2 uprights 80 3/8 in. 2 extensions 9 in. 6 brackets 1 1/4 in.
P11080090	Add-on upright 7 ft. 6 in.	2 uprights 83 1/4 in. 2 extensions 12 in. 6 brackets 1 1/4 in.
P11080096	Add-on upright 8 ft.	2 uprights 89 1/4 in. 2 extensions 12 in. 6 brackets 1 1/4 in.
P11080102	Add-on upright 8 ft. 6 in.	2 uprights 89 1/4 in. 2 extensions 16 in. 6 brackets 1 1/4 in.
P11080108	Add-on upright 9 ft.	2 uprights 89 1/4 in. 2 extensions 28 in. 6 brackets 1 1/4 in.

Other dimensions available on request

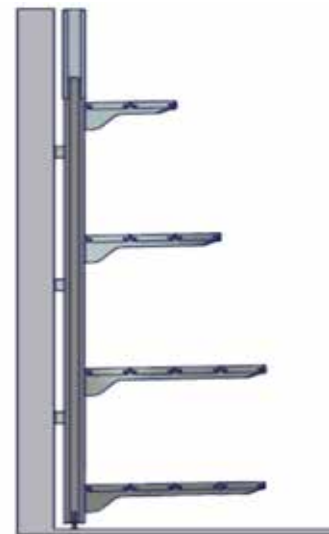

GALVANIZED STEEL ACCESSORIES

OPENSLAT SHELF WITH BRACKETS

ANJOU CODE	MEASURE (IN.)
TGG001224	12 x 24
TGG001230	12 x 30
TGG001236	12 x 36
TGG001242	12 x 42
TGG001248	12 x 48
TGG001824	18 x 24
TGG001830	18 x 30
TGG001836	18 x 36
TGG001842	18 x 42
TGG001848	18 x 48
TGG002424	24 x 24
TGG002430	24 x 30
TGG002436	24 x 36
TGG002442	24 x 42
TGG002448	24 x 48

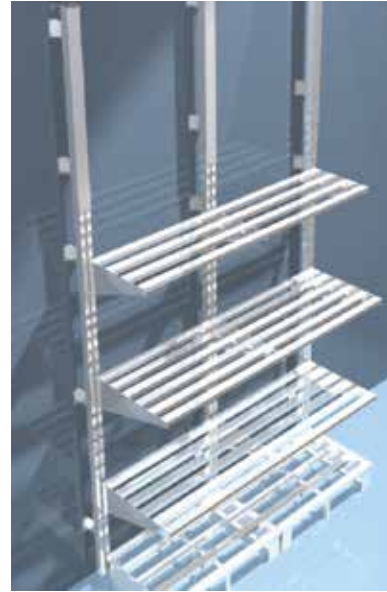

BRACKET

ANJOU CODE	MEASURE (IN.)	
018060012	12	Right - for 2 shelves
018060018	18	Right - for 3 shelves
018060024	24	Right - for 4 shelves
018060112	12	Left - for 2 shelves
018060118	18	Left - for 3 shelves
018060124	24	Left - for 4 shelves

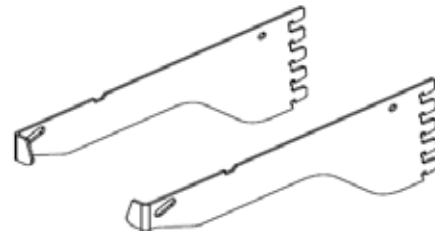

20GA GALVANIZED SHELF

ANJOU CODE	MEASURE (IN.)
018050024	6 x 24 L
018050030	6 x 30 L
018050036	6 x 36 L
018050042	6 x 42 L
018050048	6 x 48 L

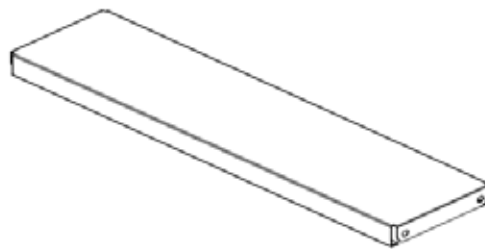

GALVANIZED WALL MOUNT FASTENER

ANJOU CODE	MEASURE (IN.)
001080001	1 1/4
001080004	4



COLD ROOM: OMEGA WALL

UPRIGHT

ANJOU CODE	MEASURE (IN.)
001090084	84
001090088	88
001090092	92
001090096	96
001090100	100
001090104	104
001090108	108
001090112	112
001090116	116
001090120	120

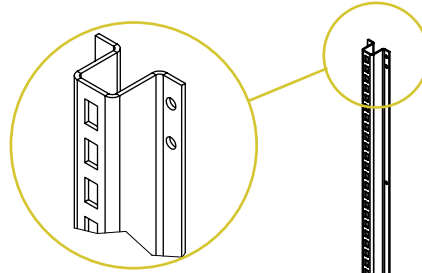

UPRIGHT EXTENSION

ANJOU CODE	MEASURE (IN.)
001091012	12
001091024	24
001091030	30
001091040	40

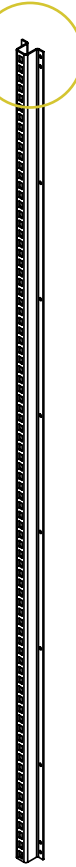

GALVANIZED BRACKET

ANJOU CODE	MEASURE (IN.)	
018060012	12	Right
018060018	18	Right
018060024	24	Right
018060112	12	Left
018060118	18	Left
018060124	24	Left

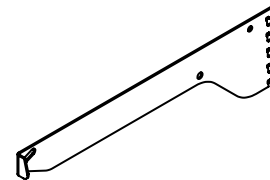

SHELF

ANJOU CODE	MEASURE (IN.)
018050024	6 x 24 L
018050030	6 x 30 L
018050036	6 x 36 L
018050042	6 x 42 L
018050048	6 x 48 L

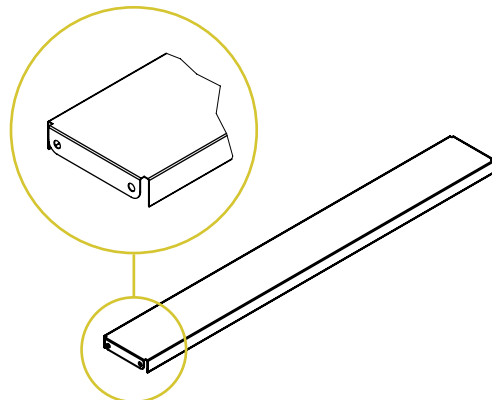

COLD ROOM: BACKLESS WALL

STARTER - D

ONLY THE BASE SHELF IS INCLUDED

CODE	MEASURE (IN.)
MDF248424	24 x 84 H - base 24 + extension 24
MDF248430	24 x 84 H - base 30 + extension 24
MDFX248424	24 x 84 H - base 24 + extension 36
MDFX248430	24 x 84 H - base 30 + extension 36
MDF308424	30 x 84 H - base 24 + extension 24
MDFX308424	30 x 84 H - base 24 + extension 36
MDF368420	36 x 84 H - base 20 + extension 24
MDF368424	36 x 84 H - base 24 + extension 24
MDF368430	36 x 84 H - base 30 + extension 24
MDFX368424	36 x 84 H - base 24 + extension 36
MDFX368430	36 x 84 H - base 30 + extension 36
MDF488424	48 x 84 H - base 24 + extension 24
MDFX488424	48 x 84 H - base 24 + extension 36

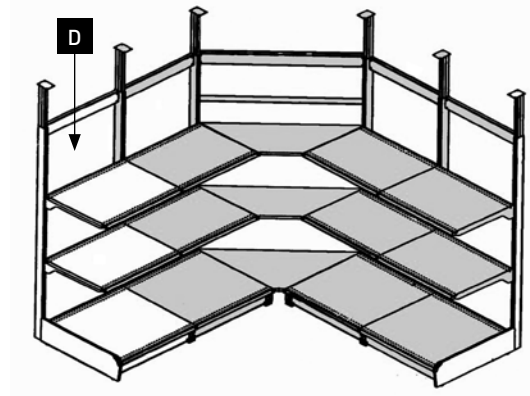

ADD-ON - A

CODE	MEASURE (IN.)
MAF248424	24 x 84 H - base 24 + extension 24
MAF248430	24 x 84 H - base 30 + extension 24
MAF308424	30 x 84 H - base 24 + extension 24
MAF308430	30 x 84 H - base 30 + extension 24
MAF368420	36 x 84 H - base 20 + extension 24
MAF368424	36 x 84 H - base 24 + extension 24
MAF368430	36 x 84 H - base 30 + extension 24
MAF488424	48 x 84 H - base 24 + extension 24

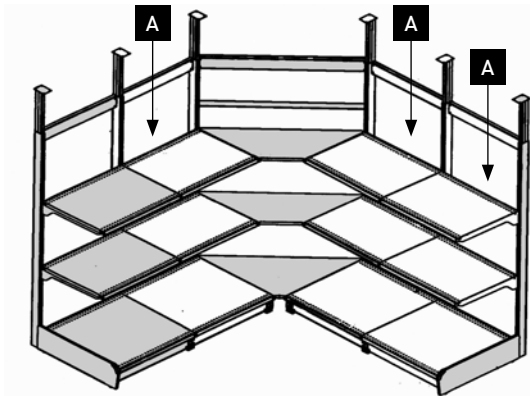

INTERIOR ADD-ON CORNER - C

CODE	MEASURE (IN.)
MAFCI8430	84 H - base 30 + extension 24
MAFCIX8424	84 H - base 24 + extension 36
MAFCIX8430	84 H - base 30 + extension 36

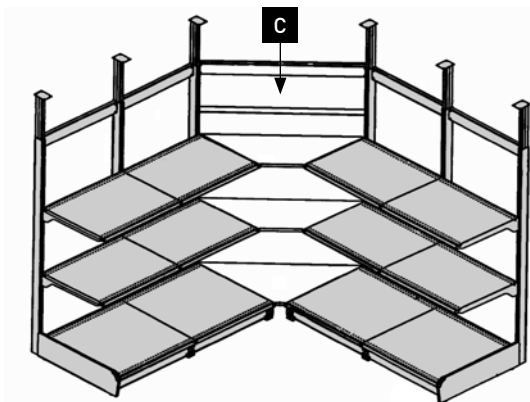

CIGARETTE CABINETS

CIGARETTE CABINET - 18 in. DEPTH

CODE	MEASURE (IN.)	
014503618293T1R	36 L x 29 H	3 drawers + 1 reserve
014503618295T	36 L x 29 H	5 drawers
014503618344T1R	36 L x 34 H	4 drawers + 1 reserve
014503618346T	36 L x 34 H	6 drawers
014503618395T1R	36 L x 39 H	5 drawers + 1 reserve
014504218395T1R	42 L x 34 H	5 drawers + 1 reserve
014504218295T	42 L x 29 H	5 drawers
014504818295T	42 L x 29 H	5 drawers
014504818293T1R	48 L x 29 H	3 drawers + 1 reserve
014504818395T1R	48 L x 39 H	5 drawers + 1 reserve
01450241854	24 L x 54 H	8 drawers
01450361854	36 L x 54 H	8 drawers
01450481854	48 L x 54 H	8 drawers



PAINT COLOURS

More colours are available



Silver Vein - ARV100



Beige - GIB490



Polar White - BLA121



Brown Rat 8019 - BRU154



Copper Vein - COV101

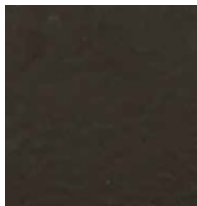

Textured Cricket - GRI547



Hammered Grey - GRI221

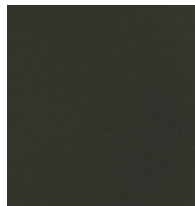

Blacksmith Grey - GRI203



Hammered Grey - GRI204

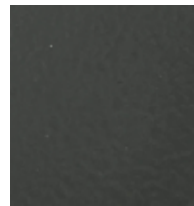

Tabby Grey - GRI022



Matte Black - NOI114

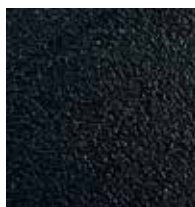

Textured Black - NOI121



Pro Red - ROU125



Super Red - ROU118

RESERVES

SOLID BACK WALL RESERVE

INCLUDES WALL BACKING AND BASE SHELVES

ANJOU CODE	MEASURE (IN.) - L x H x Base
------------	------------------------------

STARTER

RDU248418	24 x 84 x 18
RDU308414	30 x 84 x 14
RDU368418	36 x 84 x 18
RDU488414	48 x 84 x 18

ADDITION

RAU248418	24 x 84 x 18
RAU308414	30 x 84 x 14
RAU368418	36 x 84 x 18
RAU488414	48 x 84 x 18

Other dimensions available on request

PERFORATED BACK WALL RESERVE

INCLUDES WALL BACKING AND BASE SHELVES

ANJOU CODE	MEASURE (IN.) - L x H x Base
------------	------------------------------

STARTER

RDP248418	24 x 84 x 18
RDP308414	30 x 84 x 14
RDP368418	36 x 84 x 18
RDP488414	48 x 84 x 18

ADDITION

RAP248418	24 x 84 x 18
RAP308414	30 x 84 x 14
RAP368418	36 x 84 x 18
RAP488414	48 x 84 x 18

Other dimensions available on request

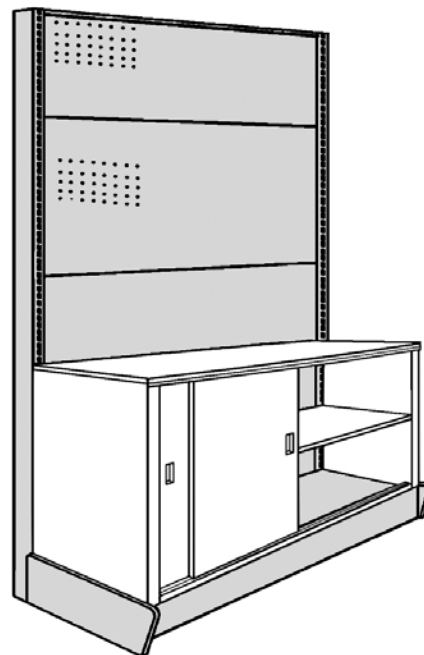

COMMERCIAL RACKING SYSTEM

MEDIUM DUTY FRAME - WS TYPE

CODE	MEASURE (IN.)	HEIGHT
30201	24 D	Available heights: 48, 54, 60, 66, 72, 84, 90, 96, 102
	30 D	
	36 D	
	42 D	
	48 D	



MEDIUM DUTY STEP BEAM - TYPE WS AVAILABLE IN R SERIES OR H SERIES

CODE	MEASURE (IN.)	DESCRIPTION
R SERIES		
30202R	1 3/4	Maximum length of 102 in. Available lengths: 48, 54, 60, 66, 66, 72, 78, 84, 90, 96, 102, 108, 114, 120
	2 1/2	
	3 1/4	
H SERIES		
30202	2	
	3	

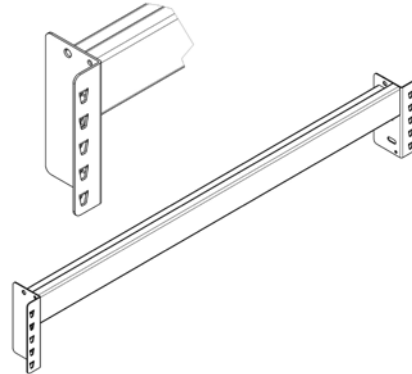

GALVANIZED SHELF

CODE	MEASURE (IN.)	
R SERIES		
402-D0-0333	1 5/8 H x 33 3/16 L (36)	3 1/2 D
402-D0-0433	1 5/8 H x 33 3/16 L (36)	4 1/2 D
402-D0-0621	1 7/16 H x 21 3/16 L (24)	5 15/16 D
402-D0-0627	1 7/16 H x 21 3/16 L (30)	5 15/16 D
402-D0-0633	1 7/16 H x 33 3/16 L (36)	5 15/16 D
402-D0-0639	1 7/16 H x 39 3/16 L (42)	5 15/16 D
402-D0-0645	1 7/16 H x 45 3/16 L (48)	5 15/16 D
H SERIES		
402-DH-0620	1 7/16 H x 20 1/8 L (24)	5 15/16 D
402-DH-0626	1 7/16 H x 26 1/8 L (30)	5 15/16 D
402-DH-0632	1 7/16 H x 32 1/8 L (36)	5 15/16 D
402-DH-0638	1 7/16 H x 38 1/8 L (42)	5 15/16 D
402-DH-0644	1 7/16 H x 44 1/8 L (48)	5 15/16 D

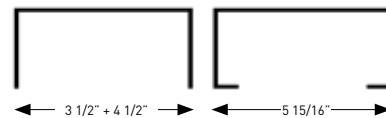
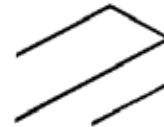
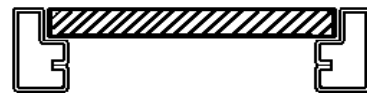

COMMERCIAL SHELVING



GROCERY



COLD ROOMS



MILLWORK FOR FRUIT SHOP







IN THIS SECTION

E SERIES

S SERIES

C SERIES

LIGHTED SHELVES

RXLAB STORAGE SYSTEMS FOR PHARMACIES

OPTIMUR

LABORATORY UNITS

DISPLAYS

PHARMACY

E SERIES - WALL



EXAMPLE*:
36 in. long x 84 in. high wall with
a 24 in. deep base shelf

PLAIN METAL BACK - REMOVABLE SHOE GUARD

	STRUCTURE CODE	AVAILABLE LENGTHS in 6-inch increments	AVAILABLE HEIGHTS in 6-inch increments	AVAILABLE DEPTHS in 2-inch increments
STARTER	MDUJ (L x H x Base)	24 to 48 in.	48 to 120 in.	6 to 30 in.
* Example:	MDUJ368424	36	84	24
ADDITION	MAUJ (L x H x Base)	24 to 48 in.	48 to 120 in.	6 to 30 in.
* Example:	MAUJ368424	36	84	24

PLAIN METAL BACK - KICKPLATE

	STRUCTURE CODE	AVAILABLE LENGTHS in 6-inch increments	AVAILABLE HEIGHTS in 6-inch increments	AVAILABLE DEPTHS in 2-inch increments
STARTER	MDUP (L x H x Base)	24 to 48 in.	48 to 120 in.	6 to 30 in.
* Example:	MDUP368424	36	84	24
ADDITION	MAUP (L x H x Base)	24 to 48 in.	48 to 120 in.	6 to 30 in.
* Example:	MAUP368424	36	84	24

This is an example of coding based on the image above. Structure codes vary according to the size chosen.

E SERIES - WALL

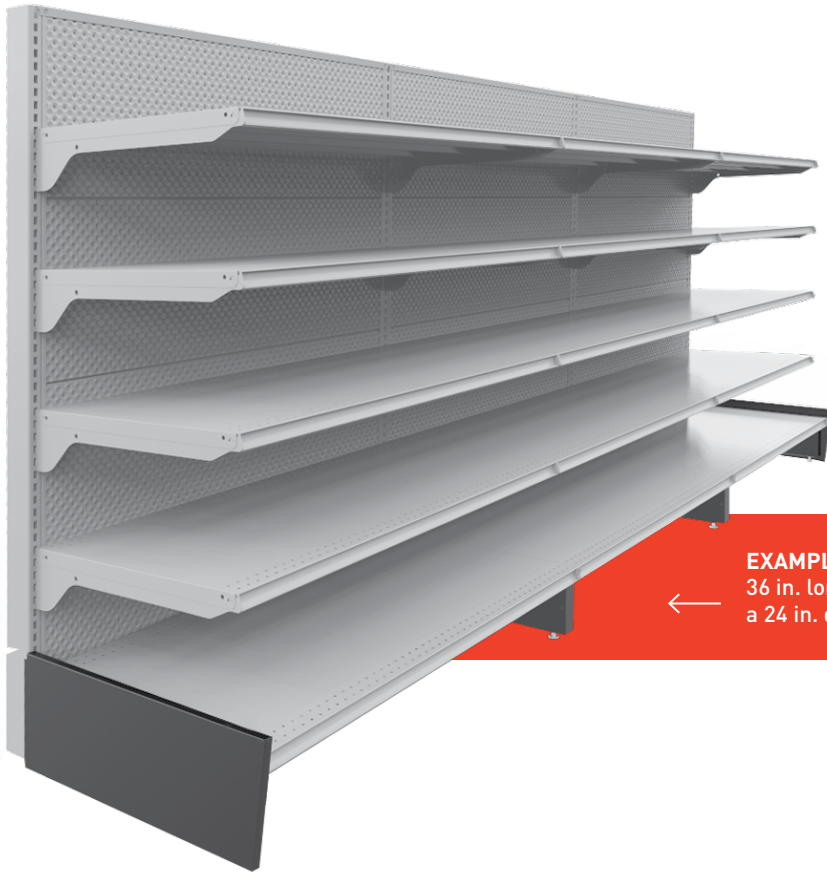

EXAMPLE*:
36 in. long x 84 in. high wall with
a 24 in. deep base shelf

PERFORATED BACK - REMOVABLE SHOE GUARD

	STRUCTURE CODE	AVAILABLE LENGTHS in 6-inch increments	AVAILABLE HEIGHTS in 6-inch increments	AVAILABLE DEPTHS in 2-inch increments
STARTER	MDPJ (L x H x Base)	24 to 48 in.	48 to 120 in.	6 to 30 in.
* Example:	MDPJ368424	36	84	24
ADDITION	MAPJ (L x H x Base)	24 to 48 in.	48 to 120 in.	6 to 30 in.
* Example:	MAPJ368424	36	84	24

PERFORATED BACK - KICKPLATE

	STRUCTURE CODE	AVAILABLE LENGTHS in 6-inch increments	AVAILABLE HEIGHTS in 6-inch increments	AVAILABLE DEPTHS in 2-inch increments
STARTER	MDPP (L x H x Base)	24 to 48 in.	48 to 120 in.	6 to 30 in.
* Example:	MDPP368424	36	84	24
ADDITION	MAPP (L x H x Base)	24 to 48 in.	48 to 120 in.	6 to 30 in.
* Example:	MAPP368424	36	84	24

This is an example of coding based on the image above. Structure codes vary according to the size chosen.

E SERIES - ISLAND

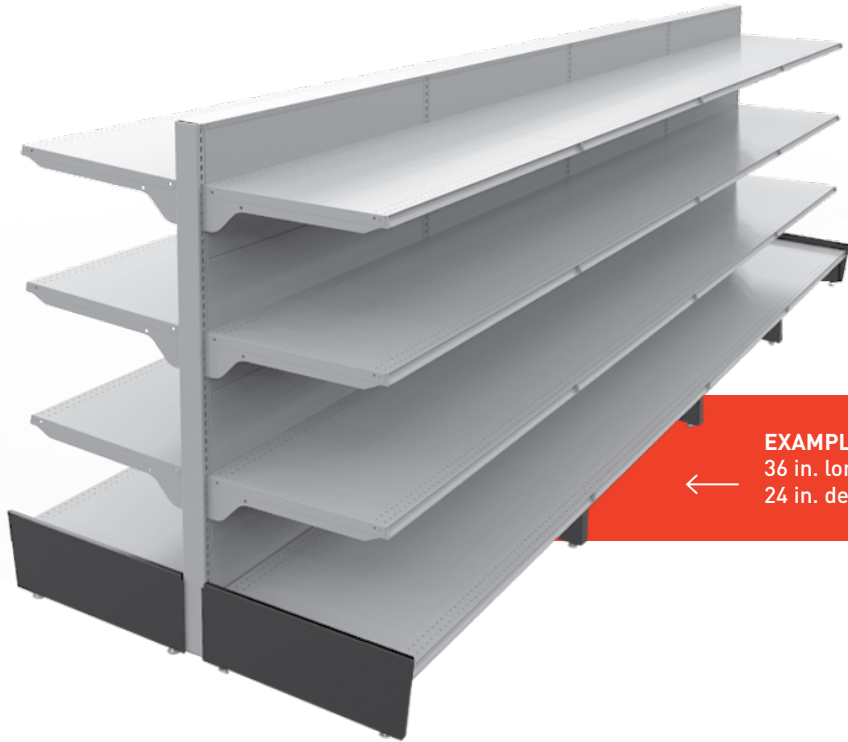

PLAIN METAL BACK - REMOVABLE SHOE GUARD

	STRUCTURE CODE	AVAILABLE LENGTHS in 6-inch increments	AVAILABLE HEIGHTS in 6-inch increments	AVAILABLE DEPTHS in 2-inch increments
STARTER	IDUJ (L x H x Base)	24 to 48 in.	48 to 120 in.	6 to 30 in.
* Example:	IDUJ36842424	36	84	24
ADDITION	IAUJ (L x H x Base)	24 to 48 in.	48 to 120 in.	6 to 30 in.
* Example:	IAUJ36842424	36	84	24

PLAIN METAL BACK - KICKPLATE

	STRUCTURE CODE	AVAILABLE LENGTHS in 6-inch increments	AVAILABLE HEIGHTS in 6-inch increments	AVAILABLE DEPTHS in 2-inch increments
STARTER	IDUP (L x H x Base)	24 to 48 in.	48 to 120 in.	6 to 30 in.
* Example:	IDUP36842424	36	84	24
ADDITION	IAUP (L x H x Base)	24 to 48 in.	48 to 120 in.	6 to 30 in.
* Example:	IAUP36842424	36	84	24

This is an example of coding based on the image above. Structure codes vary according to the size chosen.

E SERIES - ISLAND



PERFORATED BACK- REMOVABLE SHOE GUARD

	STRUCTURE CODE	AVAILABLE LENGTHS in 6-inch increments	AVAILABLE HEIGHTS in 6-inch increments	AVAILABLE DEPTHS in 2-inch increments
STARTER	IDPJ (L x H x Base)	24 to 48 in.	48 to 120 in.	6 to 30 in.
* Example:	IDPJ36842424	36	84	24
ADDITION	IAPJ (L x H x Base)	24 to 48 in.	48 to 120 in.	6 to 30 in.
* Example:	IAPJ36842424	36	84	24

PERFORATED BACK - KICKPLATE

	STRUCTURE CODE	AVAILABLE LENGTHS in 6-inch increments	AVAILABLE HEIGHTS in 6-inch increments	AVAILABLE DEPTHS in 2-inch increments
STARTER	IDPP (L x H x Base)	24 to 48 in.	48 to 120 in.	6 to 30 in.
* Example:	IDPP36842424	36	84	24
ADDITION	IAPP (L x H x Base)	24 to 48 in.	48 to 120 in.	6 to 30 in.
* Example:	IAPP36842424	36	84	24

This is an example of coding based on the image above. Structure codes vary according to the size chosen.

E SERIES - ISLAND



EXAMPLE*:

36 in. long x 84 in. high island with a 24 in. deep base shelf on each side

SLATWALL BACK - REMOVABLE SHOE GUARD

	STRUCTURE CODE	AVAILABLE LENGTHS in 6-inch increments	AVAILABLE HEIGHTS in 6-inch increments	AVAILABLE DEPTHS in 2-inch increments
STARTER	-	24 to 48 in.	48 to 120 in.	6 to 30 in.
* Example:	-	36	84	24
ADDITION	-	24 to 48 in.	48 to 120 in.	6 to 30 in.
* Example:	-	36	84	24

SLATWALL BACK - KICKPLATE

	STRUCTURE CODE	AVAILABLE LENGTHS in 6-inch increments	AVAILABLE HEIGHTS in 6-inch increments	AVAILABLE DEPTHS in 2-inch increments
STARTER	-	24 to 48 in.	48 to 120 in.	6 to 30 in.
* Example:	-	36	84	24
ADDITION	-	24 to 48 in.	48 to 120 in.	6 to 30 in.
* Example:	-	36	84	24

This is an example of coding based on the image above. Structure codes vary according to the size chosen.

E SERIES - END CAP



EXAMPLE*:
36 in. long x 84 in. high island with
a 24 in. deep base shelf

PLAIN METAL BACK - REMOVABLE SHOE GUARD

	STRUCTURE CODE	AVAILABLE LENGTHS in 6-inch increments	AVAILABLE HEIGHTS in 6-inch increments	AVAILABLE DEPTHS in 2-inch increments
STARTER	BDUJ (L x H x Base)	24 to 48 in.	48 to 120 in.	6 to 30 in.
* Example:	BDUJ368424	36	84	24
ADDITION	BAUJ (L x H x Base)	24 to 48 in.	48 to 120 in.	6 to 30 in.
* Example:	BAUJ368424	36	84	24

PLAIN METAL BACK - KICKPLATE

	STRUCTURE CODE	AVAILABLE LENGTHS in 6-inch increments	AVAILABLE HEIGHTS in 6-inch increments	AVAILABLE DEPTHS in 2-inch increments
STARTER	BDUP (L x H x Base)	24 to 48 in.	48 to 120 in.	6 to 30 in.
* Example:	BDUP368424	36	84	24
ADDITION	BAUP (L x H x Base)	24 to 48 in.	48 to 120 in.	6 to 30 in.
* Example:	BAUP368424	36	84	24

This is an example of coding based on the image above. Structure codes vary according to the size chosen.
See the **Accessories and Components** section for end caps

E SERIES - END CAP

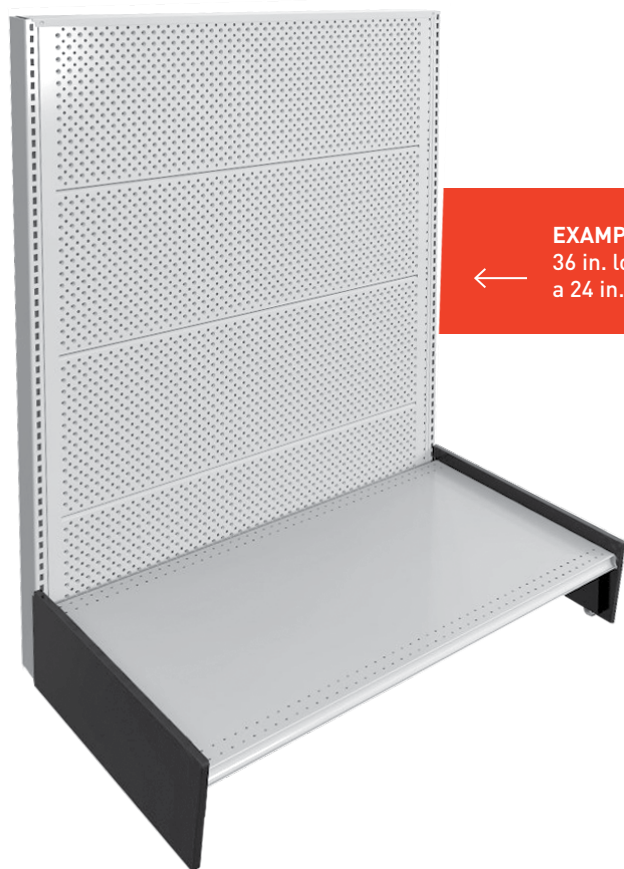

EXAMPLE*:
 ← 36 in. long x 84 in. high with
 a 24 in. deep base shelf

PERFORATED BACK - REMOVABLE SHOE GUARD

	STRUCTURE CODE	AVAILABLE LENGTHS in 6-inch increments	AVAILABLE HEIGHTS in 6-inch increments	AVAILABLE DEPTHS in 2-inch increments
STARTER	BDPJ (L x H x Base)	24 to 48 in.	48 to 120 in.	6 to 30 in.
* Example:	BDPJ368424	36	84	24
ADDITION	BAPJ (L x H x Base)	24 to 48 in.	48 to 120 in.	6 to 30 in.
* Example:	BAPJ368424	36	84	24

PERFORATED BACK - KICKPLATE

	STRUCTURE CODE	AVAILABLE LENGTHS in 6-inch increments	AVAILABLE HEIGHTS in 6-inch increments	AVAILABLE DEPTHS in 2-inch increments
STARTER	BDPP (L x H x Base)	24 to 48 in.	48 to 120 in.	6 to 30 in.
* Example:	BDPP368424	36	84	24
ADDITION	BAPP (L x H x Base)	24 to 48 in.	48 to 120 in.	6 to 30 in.
* Example:	BAPP368424	36	84	24

*This is an example of coding based on the image above. Structure codes vary according to the size chosen. See the **Accessories and Components** section for end caps*

E SERIES - END CAP



← **EXAMPLE*:**
36 in. long x 84 in. high with
a 24 in. deep base shelf

SLATWALL BACK - REMOVABLE SHOE GUARD

	STRUCTURE CODE	AVAILABLE LENGTHS in 6-inch increments	AVAILABLE HEIGHTS in 6-inch increments	AVAILABLE DEPTHS in 2-inch increments
STARTER	-	24 to 48 in.	48 to 120 in.	6 to 30 in.
* Example:	-	36	84	24
ADDITION	-	24 to 48 in.	48 to 120 in.	6 to 30 in.
* Example:	-	36	84	24

SLATWALL BACK - KICKPLATE

	STRUCTURE CODE	AVAILABLE LENGTHS in 6-inch increments	AVAILABLE HEIGHTS in 6-inch increments	AVAILABLE DEPTHS in 2-inch increments
STARTER	-	24 to 48 in.	48 to 120 in.	6 to 30 in.
* Example:	-	36	84	24
ADDITION	-	24 to 48 in.	48 to 120 in.	6 to 30 in.
* Example:	-	36	84	24

This is an example of coding based on the image above. Structure codes vary according to the size chosen.
See the **Accessories and Components** section for end caps

S SERIES - WALL



EXAMPLE*:
36 in. long x 84 in. high wall with
a 24 in. deep base shelf

SOLID MASONITE BACK - SHOE GUARD

	STRUCTURE CODE	AVAILABLE LENGTHS in 6-inch increments	AVAILABLE HEIGHTS in 6-inch increments	AVAILABLE DEPTHS in 2-inch increments
STARTER	SMBDUJ3B (L x H x Base)	24 to 48 in.	48 to 120 in.	6 to 30 in.
* Example:	SMBDUJ3B368424	36	84	24
ADDITION	SMBAUJ3B (L x H x Base)	24 to 48 in.	48 to 120 in.	6 to 30 in.
* Example:	SMBAUJ3B368424	36	84	24
BASE SHELF HEIGHT (2 heights available): 5 3/4 in. H <i>Low base</i> (from floor to shelf) 7 1/4 in. H <i>High base</i> (from floor to shelf)				

SOLID MASONITE BACK - KICKPLATE

	STRUCTURE CODE	AVAILABLE LENGTHS in 6-inch increments	AVAILABLE HEIGHTS in 6-inch increments	AVAILABLE DEPTHS in 2-inch increments
STARTER	SMBDPJ3B (L x H x Base)	24 to 48 in.	48 to 120 in.	6 to 30 in.
* Example:	SMBDPJ3B368424	36	84	24
ADDITION	SMBAUP3B (L x H x Base)	24 to 48 in.	48 to 120 in.	6 to 30 in.
* Example:	SMBAUP3B368424	36	84	24
BASE SHELF HEIGHT (2 heights available): 5 3/4 in. H <i>Low base</i> (from floor to shelf) 7 1/4 in. H <i>High base</i> (from floor to shelf)				

This is an example of coding based on the image above. Structure codes vary according to the size chosen.

S SERIES - WALL

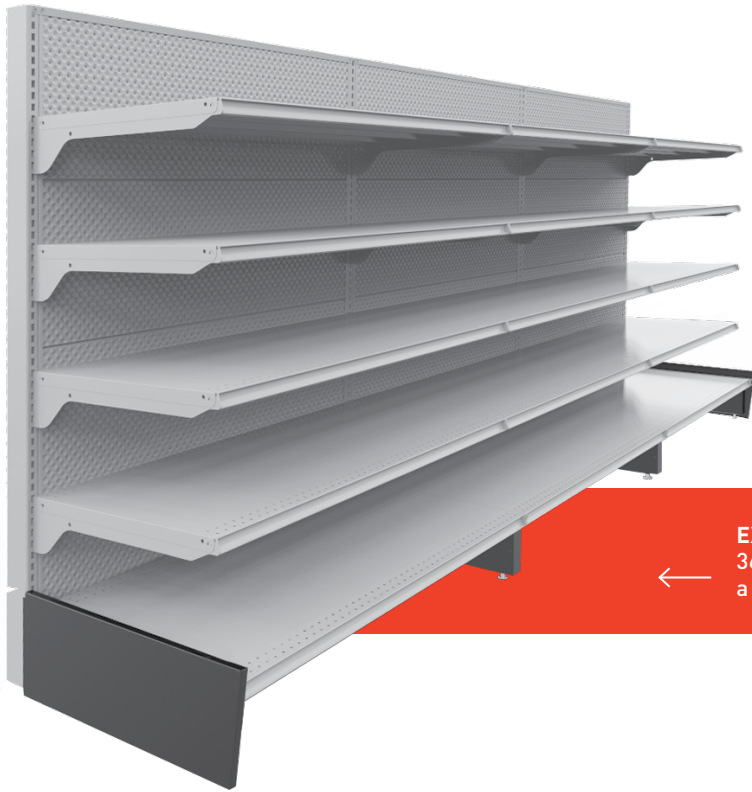

EXAMPLE*:
36 in. long x 84 in. high wall with
a 24 in. deep base shelf

PERFORATED MASONITE BACK - SHOE GUARD

	STRUCTURE CODE	AVAILABLE LENGTHS in 6-inch increments	AVAILABLE HEIGHTS in 6-inch increments	AVAILABLE DEPTHS in 2-inch increments
STARTER	SMBDPJ3B (L x H x Base)	24 to 48 in.	48 to 120 in.	6 to 30 in.
* Example:	SMBDPJ3B368424	36	84	24
ADDITION	SMBAPJ3B (L x H x Base)	24 to 48 in.	48 to 120 in.	6 to 30 in.
* Example:	SMBAPJ3B368424	36	84	24
BASE SHELF HEIGHT (2 heights available): 5 3/4 in. H <i>Low base</i> (from floor to shelf) 7 1/4 in. H <i>High base</i> (from floor to shelf)				

PERFORATED MASONITE BACK - KICKPLATE

	STRUCTURE CODE	AVAILABLE LENGTHS in 6-inch increments	AVAILABLE HEIGHTS in 6-inch increments	AVAILABLE DEPTHS in 2-inch increments
STARTER	SMBDPP3B (L x H x Base)	24 to 48 in.	48 to 96 in.	10 to 30 in.
* Example:	SMBDPP3B368424	36	84	24
ADDITION	SMBAPP3B (L x H x Base)	24 to 48 in.	48 to 96 in.	10 to 30 in.
* Example:	SMBAPP3B368424	36	84	24
BASE SHELF HEIGHT (2 heights available): 5 3/4 in. H <i>Low base</i> (from floor to shelf) 7 1/4 in. H <i>High base</i> (from floor to shelf)				

This is an example of coding based on the image above. Structure codes vary according to the size chosen.

S SERIES - WALL



EXAMPLE*:
36 in. long x 84 in. high wall with
a 24 in. deep base shelf

SLATWALL BACK - SHOE GUARD

	STRUCTURE CODE	AVAILABLE LENGTHS in 6-inch increments	AVAILABLE HEIGHTS in 6-inch increments	AVAILABLE DEPTHS in 2-inch increments
STARTER	-	24 to 48 in.	48 to 120 in.	6 to 30 in.
* Example:	-	36	84	24
ADDITION	-	24 to 48 in.	48 to 120 in.	6 to 30 in.
* Example:	-	36	84	24
BASE SHELF HEIGHT (2 heights available): 5 3/4 in. H <i>Low base</i> (from floor to shelf) 7 1/4 in. H <i>High base</i> (from floor to shelf)				

SLATWALL BACK - KICKPLATE

	STRUCTURE CODE	AVAILABLE LENGTHS in 6-inch increments	AVAILABLE HEIGHTS in 6-inch increments	AVAILABLE DEPTHS in 2-inch increments
STARTER	SMSDIP3B (L x H x Base)	24 to 48 in.	48 to 96 in.	10 to 30 in.
* Example:	SMSDIP3B36842424B	36	84	24
ADDITION	SMSAIP3B (L x H x Base)	24 to 48 in.	48 to 96 in.	10 to 30 in.
* Example:	SMSAIP3B36842424B	36	84	24
BASE SHELF HEIGHT (2 heights available): 5 3/4 in. H <i>Low base</i> (from floor to shelf) 7 1/4 in. H <i>High base</i> (from floor to shelf)				

This is an example of coding based on the image above. Structure codes vary according to the size chosen.

S SERIES - ISLAND

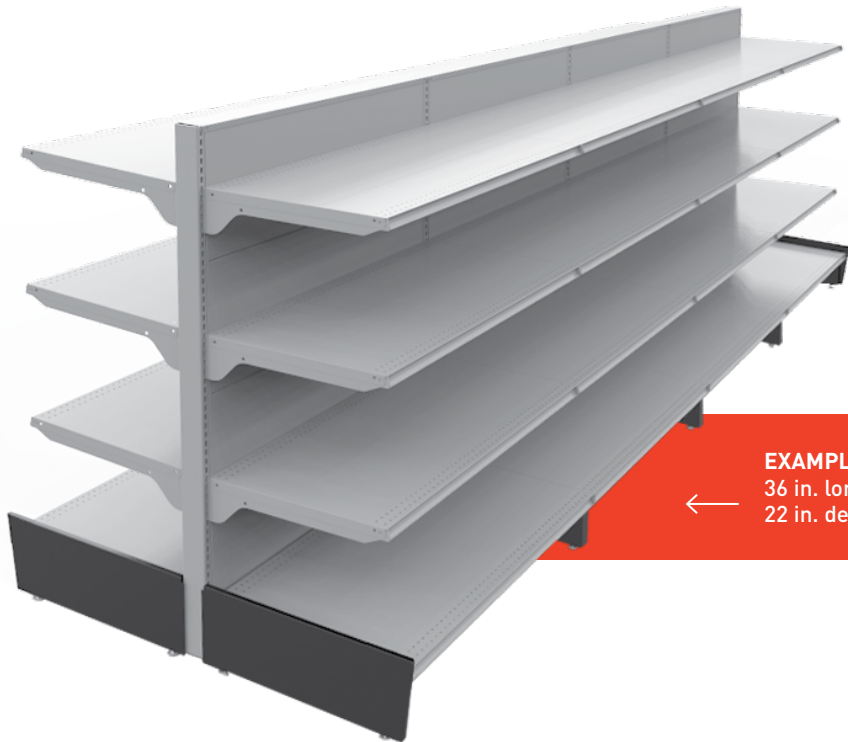

EXAMPLE*:
 36 in. long x 84 in. high island with a
 22 in. deep base shelf on each side

SOLID MASONITE BACK - SHOE GUARD

	STRUCTURE CODE	AVAILABLE LENGTHS in 6-inch increments	AVAILABLE HEIGHTS in 6-inch increments	AVAILABLE DEPTHS in 2-inch increments
STARTER	SIBDUJ3B (L x H x Base)	24 to 48 in.	48 to 120 in.	6 to 30 in.
* Example:	SIBDUJ3B36842222	36	84	22
ADDITION	SIBAUJ3B (L x H x Base)	24 to 48 in.	48 to 120 in.	6 to 30 in.
* Example:	SIBAUJ3B36842222	36	84	22
BASE SHELF HEIGHT (2 heights available): 5 3/4 in. H <i>Low base</i> (from floor to shelf) 7 1/4 in. H <i>High base</i> (from floor to shelf)				

SOLID MASONITE BACK - KICKPLATE

	STRUCTURE CODE	AVAILABLE LENGTHS in 6-inch increments	AVAILABLE HEIGHTS in 6-inch increments	AVAILABLE DEPTHS in 2-inch increments
STARTER	SIBDUP3B (L x H x Base)	24 to 48 in.	48 to 96 in.	10 to 30 in.
* Example:	SIBDUP3B36842222	36	84	22
ADDITION	SIBAU3B (L x H x Base)	24 to 48 in.	48 to 96 in.	10 to 30 in.
* Example:	SIBAU3B36842222	36	84	22
BASE SHELF HEIGHT (2 heights available): 5 3/4 in. H <i>Low base</i> (from floor to shelf) 7 1/4 in. H <i>High base</i> (from floor to shelf)				

This is an example of coding based on the image above. Structure codes vary according to the size chosen.

S SERIES - ISLAND



EXAMPLE*:
 ← 36 in. long x 84 in. high island with a
 22 in. deep base shelf on each side

PERFORATED MASONITE BACK - SHOE GUARD

	STRUCTURE CODE	AVAILABLE LENGTHS in 6-inch increments	AVAILABLE HEIGHTS in 6-inch increments	AVAILABLE DEPTHS in 2-inch increments
STARTER	SIBDPJ3B (L x H x Base)	24 to 48 in.	48 to 96 in.	10 to 30 in.
* Example:	SIBDPJ3B36842222	36	84	22
ADDITION	SIBAPJ3B (L x H x Base)	24 to 48 in.	48 to 96 in.	10 to 30 in.
* Example:	SIBAPJ3B36842222	36	84	22
BASE SHELF HEIGHT (2 heights available): 5 3/4 in. H <i>Low base</i> (from floor to shelf) 7 1/4 in. H <i>High base</i> (from floor to shelf)				

PERFORATED MASONITE BACK - KICKPLATE

	STRUCTURE CODE	AVAILABLE LENGTHS in 6-inch increments	AVAILABLE HEIGHTS in 6-inch increments	AVAILABLE DEPTHS in 2-inch increments
STARTER	SIBDPP3B (L x H x Base)	24 to 48 in.	48 to 96 in.	10 to 30 in.
* Example:	SIBDPP3B36842222	36	84	22
ADDITION	SIBAPP3B (L x H x Base)	24 to 48 in.	48 to 96 in.	10 to 30 in.
* Example:	SIBAPP3B36842222	36	84	22
BASE SHELF HEIGHT (2 heights available): 5 3/4 in. H <i>Low base</i> (from floor to shelf) 7 1/4 in. H <i>High base</i> (from floor to shelf)				

This is an example of coding based on the image above. Structure codes vary according to the size chosen.

S SERIES - ISLAND



EXAMPLE*:
 ← 36 in. long x 84 in. high island with a 24 in. deep base shelf on each side

SLATWALL BACK - KICKPLATE

	STRUCTURE CODE	AVAILABLE LENGTHS in 6-inch increments	AVAILABLE HEIGHTS in 6-inch increments	AVAILABLE DEPTHS in 2-inch increments
STARTER	SISDIP3B (L x H x Base)	24 to 48 in.	48 to 96 in.	10 to 30 in.
* Example:	SISDIP3B36842424B	36	84	24
ADDITION	SISAIP3B (L x H x Base)	24 to 48 in.	48 to 96 in.	10 to 30 in.
* Example:	SISAIP3B36842424B	36	84	24
BASE SHELF HEIGHT (2 heights available): 5 3/4 in. H <i>Low base</i> (from floor to shelf) 7 1/4 in. H <i>High base</i> (from floor to shelf)				

This is an example of coding based on the image above. Structure codes vary according to the size chosen.

S SERIES - END CAP



EXAMPLE*:
 ← 36 in. long x 96 in. high island with a 22 in. deep base shelf

SOLID MASONITE BACK - SHOE GUARD

	STRUCTURE CODE	AVAILABLE LENGTHS in 6-inch increments	AVAILABLE HEIGHTS in 6-inch increments	AVAILABLE DEPTHS in 2-inch increments
STARTER	SBBDUJ3H (L x H x Base)	24 to 48 in.	48 to 96 in.	10 to 30 in.
* Example:	SBBDUJ3H369624	36	96	24
ADDITION	SBBAUJ3H (L x H x Base)	24 to 48 in.	48 to 96 in.	10 to 30 in.
* Example:	SBBAUJ3H369624	36	96	24
BASE SHELF HEIGHT (2 heights available): 5 3/4 in. H <i>Low base</i> (from floor to shelf) 7 1/4 in. H <i>High base</i> (from floor to shelf)				

SOLID MASONITE BACK - KICKPLATE

	STRUCTURE CODE	AVAILABLE LENGTHS in 6-inch increments	AVAILABLE HEIGHTS in 6-inch increments	AVAILABLE DEPTHS in 2-inch increments
STARTER	SBBDUP3H (L x H x Base)	24 to 48 in.	48 to 96 in.	10 to 30 in.
* Example:	SBBDUP3H369624	36	96	24
ADDITION	SBBAUP3H (L x H x Base)	24 to 48 in.	48 to 96 in.	10 to 30 in.
* Example:	SBBAUP3H369624	36	96	24
BASE SHELF HEIGHT (2 heights available): 5 3/4 in. H <i>Low base</i> (from floor to shelf) 7 1/4 in. H <i>High base</i> (from floor to shelf)				

This is an example of coding based on the image above. Structure codes vary according to the size chosen.
 See the **Accessories and Components** section for end caps

S SERIES - END CAP

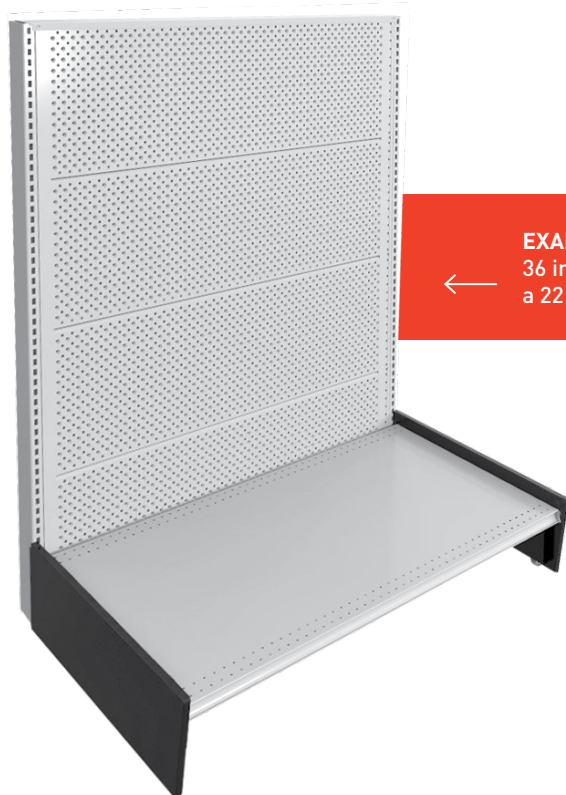

EXAMPLE*:
 ← 36 in. long x 96 in. high island with a 22 in. deep base shelf

PERFORATED MASONITE BACK - SHOE GUARD

	STRUCTURE CODE	AVAILABLE LENGTHS in 6-inch increments	AVAILABLE HEIGHTS in 6-inch increments	AVAILABLE DEPTHS in 2-inch increments
STARTER	SBDPJ3H (L x H x Base)	24 to 48 in.	48 to 96 in.	10 to 30 in.
* Example:	SBDPJ3H369624	36	96	24
ADDITION	SBBAPJ3H (L x H x Base)	24 to 48 in.	48 to 96 in.	10 to 30 in.
* Example:	SBBAPJ3H369624	36	96	24
BASE SHELF HEIGHT (2 heights available): 5 3/4 in. H <i>Low base</i> (from floor to shelf) 7 1/4 in. H <i>High base</i> (from floor to shelf)				

PERFORATED MASONITE BACK - KICKPLATE

	STRUCTURE CODE	AVAILABLE LENGTHS in 6-inch increments	AVAILABLE HEIGHTS in 6-inch increments	AVAILABLE DEPTHS in 2-inch increments
STARTER	SBDPP3H (L x H x Base)	24 to 48 in.	48 to 96 in.	10 to 30 in.
* Example:	SBDPP3H369624	36	96	24
ADDITION	SBBAPP3H (L x H x Base)	24 to 48 in.	48 to 96 in.	10 to 30 in.
* Example:	SBBAPP3H369624	36	96	24
BASE SHELF HEIGHT (2 heights available): 5 3/4 in. H <i>Low base</i> (from floor to shelf) 7 1/4 in. H <i>High base</i> (from floor to shelf)				

This is an example of coding based on the image above. Structure codes vary according to the size chosen.
 See the **Accessories and Components** section for end caps

S SERIES - END CAP



EXAMPLE*:
 ← 36 in. long x 90 in. high island with a 22 in. deep base shelf

SLATWALL BACK - SHOE GUARD

	STRUCTURE CODE	AVAILABLE LENGTHS in 6-inch increments	AVAILABLE HEIGHTS in 6-inch increments	AVAILABLE DEPTHS in 2-inch increments
STARTER	-	24 to 48 in.	48 to 96 in.	10 to 30 in.
* Example:	-	36	96	24
ADDITION	-	24 to 48 in.	48 to 96 in.	10 to 30 in.
* Example:	-	36	96	24

BASE SHELF HEIGHT (2 heights available): 5 3/4 in. H *Low base* (from floor to shelf)
 7 1/4 in. H *High base* (from floor to shelf)

SLATWALL BACK - KICKPLATE

	STRUCTURE CODE	AVAILABLE LENGTHS in 6-inch increments	AVAILABLE HEIGHTS in 6-inch increments	AVAILABLE DEPTHS in 2-inch increments
STARTER	SBSDIP3B (L x H x Base)	24 to 48 in.	48 to 96 in.	10 to 30 in.
* Example:	SBSDIP3B369024	36	96	24
ADDITION	SBSAIP3B (L x H x Base)	24 to 48 in.	48 to 96 in.	10 to 30 in.
* Example:	SBSAIP3B369024	36	96	24

BASE SHELF HEIGHT (2 heights available): 5 3/4 in. H *Low base* (from floor to shelf)
 7 1/4 in. H *High base* (from floor to shelf)

This is an example of coding based on the image above. Structure codes vary according to the size chosen.
 See the **Accessories and Components** section for end caps

C SERIES - WALL



DIMENSIONS

MEASURE (IN.)

AVAILABLE HEIGHTS 36 - 42 - 48 - 54 - 60 - 66 - 72

AVAILABLE WIDTHS 24 - 30 - 36 - 48

AVAILABLE BASE DEPTHS 8 - 10 - 12 - 14 - 16

AVAILABLE SHELF DEPTHS 8 - 10 - 12 - 14 - 16

OPTION: with or without shelves

BACK OPTION: masonite (plain or perforated), wire mesh and slatwall

C SERIES - ISLAND (END CAP AND PANEL OPTIONAL)



← Plain back island with base, slatwall panel and accessories (optional end cap or panel)

DIMENSIONS

MEASURE (IN.)

AVAILABLE HEIGHTS	36 - 42 - 48 - 54 - 60 - 66 - 72
AVAILABLE WIDTHS	24 - 30 - 36 - 48
AVAILABLE BASE DEPTHS	6 - 8 - 10 - 12 - 14 - 16
AVAILABLE SHELF DEPTHS	6 - 8 - 10 - 12 - 14 - 16

OPTION: with or without shelves

OPTION: on wheels or levelers

BACK OPTION: masonite (plain or perforated), wire mesh and slatwall

C SERIES - SEVERAL POSSIBLE CONFIGURATIONS



← Slatwall island with base, end cap and various accessories



→ Island with various backs, end caps and accessories

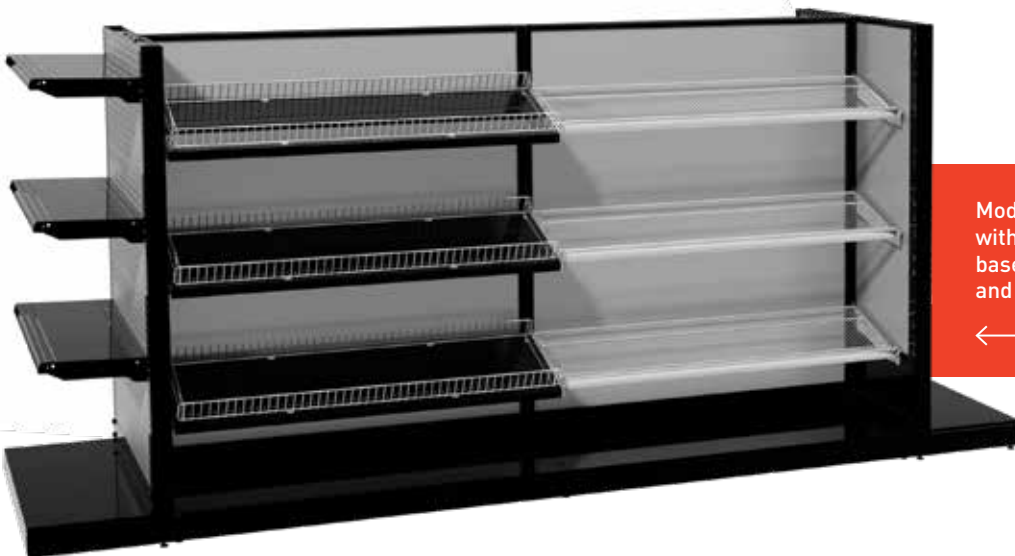

← Modular island with various backs, bases, island ends and accessories

C SERIES -END CAP OPTION

L-SHAPED END CAP FOR RIGHT ISLAND

CODE	MEASURE (IN.)
0023091565D	15 x 65

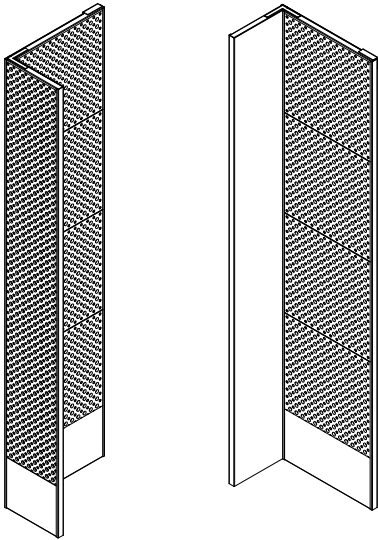

LIGHTED SHELVES

TEMPERED GLASS SHELF

CODE	MEASURE (IN.)
Width	24, 30, 36, 40, 48
Depth	6, 12, 18, 20, 24



LED LIGHTED SHELF

CODE	MEASURE (IN.)
Width	24, 30, 36, 40, 48
Depth	6, 12, 18, 20, 24, 30

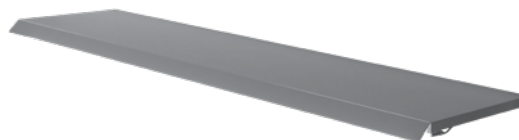

LED LIGHTED SHELF WITH TRIM

CODE	MEASURE (IN.)
Width	24, 30, 36, 40, 48
Depth	6, 12, 18, 20, 24, 30

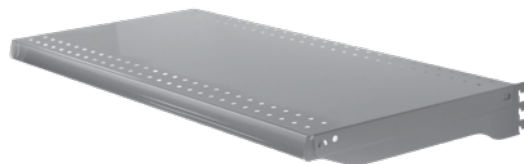

STARFIRE SHELF

CODE	MEASURE (IN.)
Width	24, 30, 36, 40, 48
Depth	8 to 16

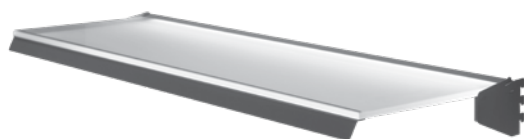

RXLAB STORAGE SYSTEM FOR LABORATORY

FIXED PANEL - 8-FT. PANEL SECTION (STRUCTURE)

SB CODE	ANJOU CODE	MEASURE (IN.)
-	RXM884(16)	16 L x 84 H
RXM88432	RXM884(32)	32 L x 84 H
-	RXM884(40)	40 L x 84 H
-	RXM884(48)	48 L x 84 H



WALL WITH SLIDING PANELS

SB CODE	ANJOU CODE	MEASURE (IN.)
-	RXM884(16)	16 L x 84 H
-	RXM884(32)	32 L x 84 H
-	RXM884(40)	40 L x 84 H
-	RXM884(48)	48 L x 84 H
-	RXMCD8084	80 L x 84 H
RXMC9684	RXMCD9684	96 L x 84 H
-	RXMCD12084	120 L x 84 H
-	RXMCD14484	144 L x 84 H
-	RXMCA7284	72 L x 84 H
-	RXMCA8084	80 L x 84 H
-	RXMCA9684	96 L x 84 H
-	RXMCA12084	120 L x 84 H
-	RXMCA14484	144 L x 84 H



FREESTANDING ISLAND

SB CODE	ANJOU CODE	MEASURE (IN.)
-	RXI16840909	16 L x 84 H
DIUP32840909	RXI32840909	32 L x 84 H
DIUP48840909	RXI48840909	48 L x 84 H

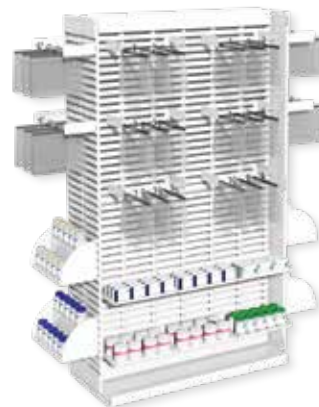

ACCESSORIES – FOR RXLAB STORAGE SYSTEM

STRAIGHT STEEL TRAY FOR SLATWALL PANEL

SB CODE	ANJOU CODE	MEASURE (IN.)
0391071416	0391071416	7 1/2 D x 16 L
0391071424	0391071424	7 1/2 D x 24 L
0391071216	0391091216	9 1/2 D x 16 L
0391071624	0391091224	9 1/2 D x 24 L



STAIRCASE SHELF FOR TELEPHONE

SB CODE	ANJOU CODE	MEASURE (IN.)
M20075174B	03917090916	9 D x 9 H x 16 L

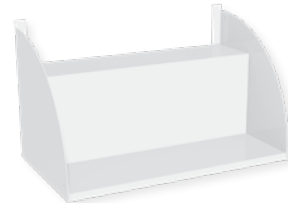

SLOPED SHELF FOR SLATWALL PANEL

SB CODE	ANJOU CODE	MEASURE (IN.)
M20075174A	039161011	10 1/4 L x 11 D



DISPILL HANGER

SB CODE	ANJOU CODE	MEASURE (IN.)
039190014	039190014	14



HANGER BAR FOR MONACO BAG

CODE	MEASURE (IN.)
M20095752A500	8 x 24
M20095752A503	8 x 30
M20095752A501	8 x 36
M20095752A502	8 x 48
M22035951A500	12 x 24
M22035951A503	12 x 30
M22035951A501	12 x 36
M22035951A502	12 x 48



MONACO BAG - TYPE #103

CODE	MEASURE (IN.)
-	12 L x 9 H



ALPHABETICAL INDEX FOR MONACO BAG

CODE	MEASURE (IN.)
-	XX L x XX H





6-INCH ALUMINIUM PANEL STRIP - Natural or white finish

SPECIAL ORDER



BASE SHELF FOR W SERIES

CODE	MEASURE (IN.)
15002B7J16A700	7 1/2 x 16 L
15002B7J32A700	7 1/2 x 32 L
15002B7J48A700	7 1/2 x 48 L
15002B9J16A700	9 1/2 x 16 L
15002B9J32A700	9 1/2 x 32 L
15002B9J48A700	9 1/2 x 48 L

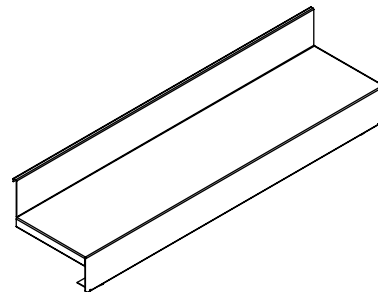

SHELF FOR SLATWALL PANEL

SB CODE	ANJOU CODE	MEASURE (IN.)
150027E16A	B150027E16A	7 1/4 x 16
M20075174C	0393091216	9 1/2 x 16



STAIRCASE SHELF FOR TELEPHONE

SB CODE	ANJOU CODE	MEASURE (IN.)
M20075174B	03917090916	9 D x 9 H x 16 L

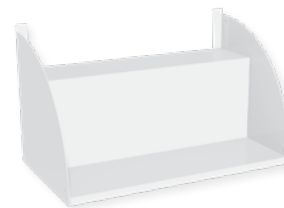

SLOPED SHELF FOR SLATWALL PANEL

SB CODE	ANJOU CODE	MEASURE (IN.)
M20075174A	039161011	10 1/4 L x 11 D



BOTTLE BAY UNITS - METAL BACKING

SINGLE - 24 in. L SECTION

SB CODE	ANJOU CODE	MEASURE (IN.)
LAD542407	-	7 x 24 x 54
LAD592407	-	7 x 24 x 59
LAD842407	-	7 x 24 x 84
LAD842406	-	6 x 24 x 84

SINGLE - 30 in. L SECTION

SB CODE	ANJOU CODE	MEASURE (IN.)
LAD543007	-	7 x 30 x 54
LAD553007	-	7 x 30 x 55
LAD743007	-	7 x 30 x 74
LAD843007	BLAD853007	7 x 30 x 84
LAD843006	-	6 x 30 x 84

SINGLE - 36 in. L SECTION

SB CODE	ANJOU CODE	MEASURE (IN.)
LAD473607	-	7 x 36 x 47
LAD483607	-	7 x 36 x 48
LAD543607	-	7 x 36 x 54
LAD853607	BLAD853607	7 x 36 x 84
LAD843606	-	6 x 36 x 84

SINGLE - 48 in. L SECTION

SB CODE	ANJOU CODE	MEASURE (IN.)
LAD544807	-	7 x 48 x 54
LAD554807	-	7 x 48 x 55
LAD594807	-	7 x 48 x 59
LAD764807	-	7 x 48 x 76
LAD844807	BLAD854807	7 x 48 x 84
LAD844806	-	6 x 48 x 84

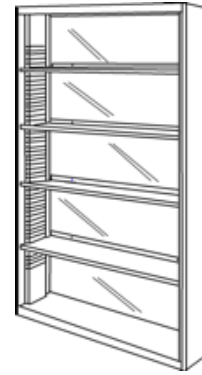

BOTTLE BAY UNITS - METAL BACKING

DOUBLE - 24 in. L SECTION

SB CODE	ANJOU CODE	MEASURE (IN.)
LAD842412	-	12 x 24 x 84
LAD852414	BLAD852414	14 x 24 x 84

DOUBLE - 30 in. L SECTION

SB CODE	ANJOU CODE	MEASURE (IN.)
LAD843012	-	12 x 30 x 84
LAD853014	BLAD852414	14 x 30 x 84

DOUBLE - 36 in. L SECTION

SB CODE	ANJOU CODE	MEASURE (IN.)
LAD843612	-	12 x 36 x 84
LAD853614	BLAD853614	14 x 36 x 84

DOUBLE - 48 in. L SECTION

SB CODE	ANJOU CODE	MEASURE (IN.)
LAD844812	-	12 x 48 x 84
LAD854814	BLAD854814	14 x 48 x 84

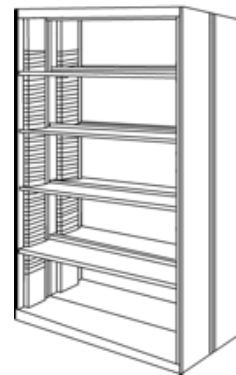
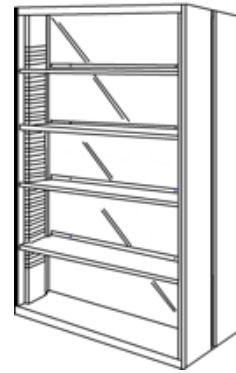

ACCESSORIES FOR BOTTLE BAY UNIT

CROSSBAR FOR BOTTLE BAY UNIT

SB CODE	ANJOU CODE	MEASURE (IN.)
021020024	-	24
021020030	B021020030	30
021020036	B021020036	36
021020048	B021020048	48



WALL ANCHOR

SB CODE	ANJOU CODE	MEASURE (IN.)
021030022	B021030022	3

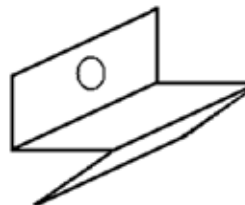

SHELF FOR BOTTLE BAY UNIT

SB CODE	ANJOU CODE	MEASURE (IN.)
021041407	B021041407	7 1/4 x 14
021042407	B021042407	7 1/4 x 24
021043007	B021043007	7 1/4 x 30
021043607	B021043607	7 1/4 x 36
021044807	B021044807	7 1/4 x 48

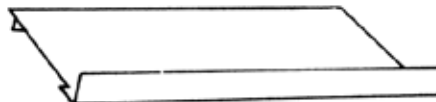

CLIP FOR BOTTLE BAY UNIT

SB CODE	ANJOU CODE	MEASURE (IN.)
021060002	-	5 3/4 x 3/4 End
021060005	-	5 7/8 x 3 End à End
021060004	-	20 x 1 1/2 Double

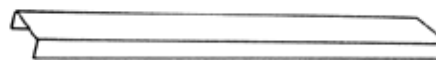

TOP AND BOTTOM FOR BOTTLE BAY UNIT

SB CODE	ANJOU CODE	MEASURE (IN.)
021081407	B021081407	7 1/4 x 14
021082407	B021082407	7 1/4 x 24
021083007	-	7 1/4 x 30
021083607	-	7 1/4 x 36
021084807	-	7 1/4 x 48

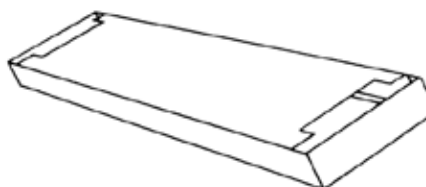

ACCESSORIES FOR BOTTLE BAY UNIT

METAL BACKING FOR BOTTLE BAY UNIT

SB CODE	ANJOU CODE	MEASURE (IN.)
021104014	B021104014	14 x 40
021104024	-	24 x 40
021104030	-	30 x 40
021104036	B021104036	36 x 40
021104048	-	48 x 40



PLASTIC JOINER FOR BACK PANEL - WHITE FINISH

SB CODE	ANJOU CODE	MEASURE (IN.)
021110014	B021110014	12 [14]
021110024	-	22 [24]
021110030	-	28 [30]
021110036	B021110036	34 [36]
021110048	-	46 [48]



FINISHING CORNER FOR BOTTLE BAY UNIT

CODE	MEASURE (IN.)		
021058407	7 1/2 x 7 1/2 x 84	Single	1
021058414	7 1/2 x 15 x 84	Double	2

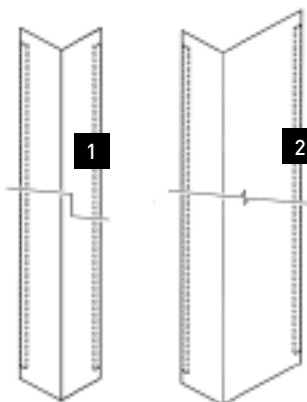

END CAP, ADAPTOR, UPRIGHT FOR BOTTLE BAY UNIT

CODE	MEASURE (IN.)		
021068407	7 x 84	Finishing end cap	1
021060003	7 x 7	L-shaped adaptor	2
021078407	7 1/4 x 84	Upright	3

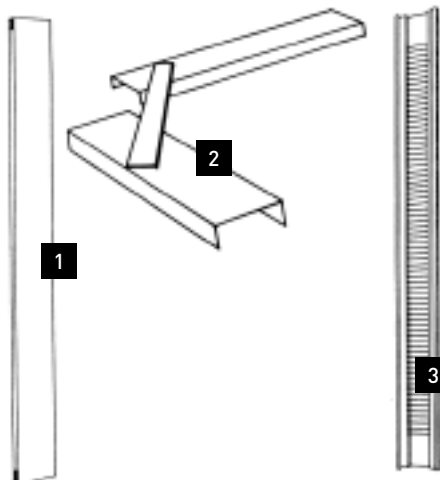

ACCESSORIES

MONEY BOX

CODE	MEASURE (IN.)
043070101	44 L x 31 H x 6 1/2 P

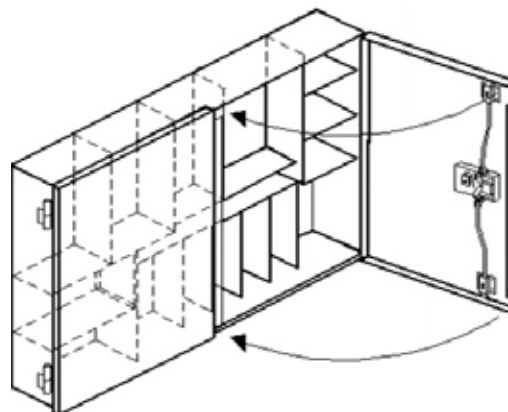

DIVIDING WALL FOR O.T.C. SECTION

SPECIAL ORDER



UPRIGHT SIDE CAP FOR GLASS BACKING

CODE	MEASURE (IN.)
035-01-0007	7
035-01-0014	14 1/2
035-01-0018	18
035-01-0022	21 5/8
035-01-0029	29
035-01-0030	30



BOTTOM DOUBLE CAP FOR GLASS BACKING

CODE	MEASURE (IN.)
035-01-0124	21 3/8
035-01-0130	27 3/8
035-01-0136	33 3/8
035-01-0148	45 3/8

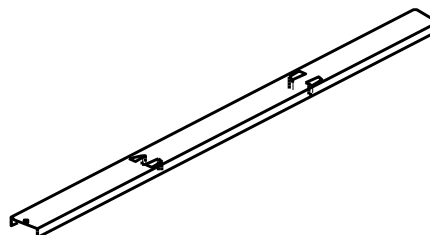

ACCESSORIES

VIAL SHELF

CODE	MEASURE (IN.)	
043-03-3608	8 x 36	12 dividers included
043-03-3610	10 x 36	12 dividers included
043-03-4808	8 x 48	12 dividers included
043-03-4810	10 x 48	12 dividers included
043-03-0008	8 in. long divider for vial shelf	
043-03-0010	10 in. long divider for vial shelf	

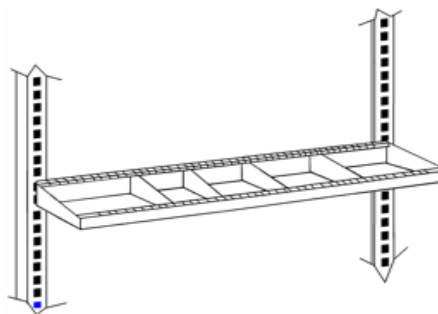

PILL SUPPORT

CODE	MEASURE (IN.)
M21095520A500	12 x 48

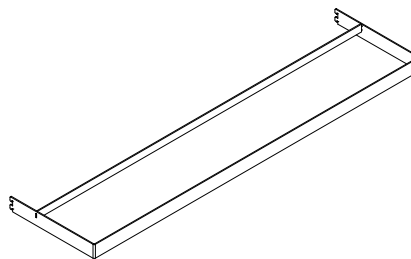

HANGER BAR FOR MONACO BAG

CODE	MEASURE (IN.)
M20095752A500	8 x 24
M20095752A503	8 x 30
M20095752A501	8 x 36
M20095752A502	8 x 48
M22035951A500	12 x 24
M22035951A503	12 x 30
M22035951A501	12 x 36
M22035951A502	12 x 48

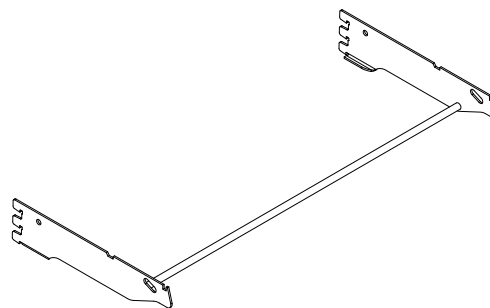

ACCESSORIES

METAL SHOWCASE WITH GLASS DOORS SHELVES AND LOCK NOT INCLUDED

CODE	MEASURE (IN.)	
022-03-4830	48 L x 30 H x 12 D	With metal top
022-03-4847	48 L x 47 H x 16 D	With metal top
022-04-4830	48 L x 30 H x 16 D	With metal top
ARM-00-4816	48 L x 42 H x 16 D	With glass top



LOCK

CODE	DESCRIPTION
022-03-0000	TDK7 Sliding type lock for metal showcase with glass doors



NARCOTIC CABINET INCLUDES KEY LOCK WITH SECURITY CODE

CODE	MEASURE (IN.)
021013639JA800	36 L x 40 H

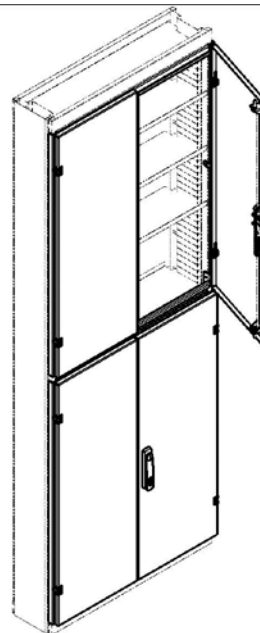

DISPLAYS

ROTATING TRIANGULAR HOOK DISPLAY

CODE	MEASURE (IN.)	
PRC-01-0030	30 L x 58 H	Single - 24 hooks
PRC-01-0036	36 L x 58 H	Single - 24 hooks
PRC-01-0048	48 L x 58 H	Single - 24 hooks
PRC-02-0030	30 L x 58 H	Double - 48 hooks
PRC-02-0036	36 L x 58 H	Double - 48 hooks
043-29-0010	10	Extension 1



FIXED BASE PROMO BASKET (SAM DISPLAY)

CODE	MEASURE (IN.)	
SAM001715	15 3/4 x 17 3/8	Adjustable with kickplate and adaptor and sign holder
SAM001414	12 3/4 x 12 3/4	Non-adjustable with kickplate and adaptor and sign holder

Ajustable model illustrated here

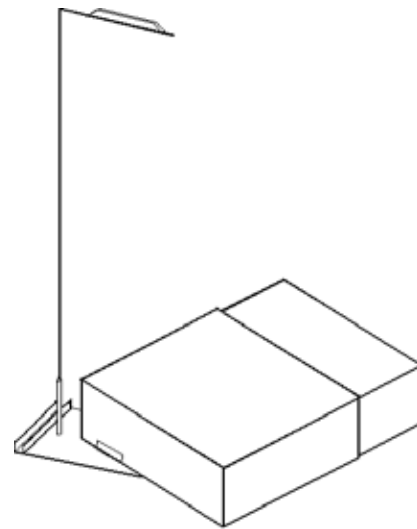



COSMETIC DISPLAYS



COSMETIC DISPLAYS AND COUNTERS



COURTESY COUNTERS







IN THIS SECTION

E SERIES

S SERIES

C SERIES

CABINETS

DISPLAYS

TOOL SECTION

ACCESSORIES

HARDWARE

E SERIES - WALL



EXAMPLE*:
36 in. long x 84 in. high wall with
a 24 in. deep base shelf

PLAIN METAL BACK - REMOVABLE SHOE GUARD

	STRUCTURE CODE	AVAILABLE LENGTHS in 6-inch increments	AVAILABLE HEIGHTS in 6-inch increments	AVAILABLE DEPTHS in 2-inch increments
STARTER	MDUJ (L x H x Base)	24 to 48 in.	48 to 120 in.	6 to 30 in.
* Example:	MDUJ368424	36	84	24
ADDITION	MAUJ (L x H x Base)	24 to 48 in.	48 to 120 in.	6 to 30 in.
* Example:	MAUJ368424	36	84	24

PLAIN METAL BACK - KICKPLATE

	STRUCTURE CODE	AVAILABLE LENGTHS in 6-inch increments	AVAILABLE HEIGHTS in 6-inch increments	AVAILABLE DEPTHS in 2-inch increments
STARTER	MDUP (L x H x Base)	24 to 48 in.	48 to 120 in.	6 to 30 in.
* Example:	MDUP368424	36	84	24
ADDITION	MAUP (L x H x Base)	24 to 48 in.	48 to 120 in.	6 to 30 in.
* Example:	MAUP368424	36	84	24

This is an example of coding based on the image above. Structure codes vary according to the size chosen.

E SERIES - WALL

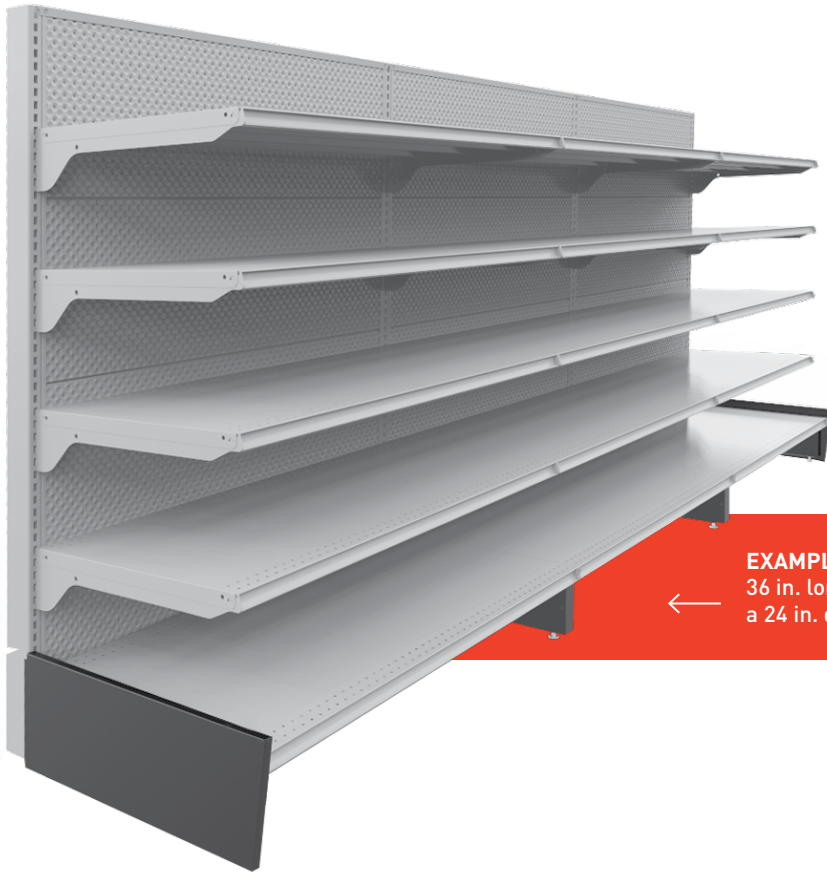

PERFORATED BACK - REMOVABLE SHOE GUARD

	STRUCTURE CODE	AVAILABLE LENGTHS in 6-inch increments	AVAILABLE HEIGHTS in 6-inch increments	AVAILABLE DEPTHS in 2-inch increments
STARTER	MDPJ (L x H x Base)	24 to 48 in.	48 to 120 in.	6 to 30 in.
* Example:	MDPJ368424	36	84	24
ADDITION	MAPJ (L x H x Base)	24 to 48 in.	48 to 120 in.	6 to 30 in.
* Example:	MAPJ368424	36	84	24

PERFORATED BACK - KICKPLATE

	STRUCTURE CODE	AVAILABLE LENGTHS in 6-inch increments	AVAILABLE HEIGHTS in 6-inch increments	AVAILABLE DEPTHS in 2-inch increments
STARTER	MDPP (L x H x Base)	24 to 48 in.	48 to 120 in.	6 to 30 in.
* Example:	MDPP368424	36	84	24
ADDITION	MAPP (L x H x Base)	24 to 48 in.	48 to 120 in.	6 to 30 in.
* Example:	MAPP368424	36	84	24

This is an example of coding based on the image above. Structure codes vary according to the size chosen.

E SERIES - ISLAND



PLAIN METAL BACK - REMOVABLE SHOE GUARD

	STRUCTURE CODE	AVAILABLE LENGTHS in 6-inch increments	AVAILABLE HEIGHTS in 6-inch increments	AVAILABLE DEPTHS in 2-inch increments
STARTER	IDUJ (L x H x Base)	24 to 48 in.	48 to 120 in.	6 to 30 in.
* Example:	IDUJ36842424	36	84	24
ADDITION	IAUJ (L x H x Base)	24 to 48 in.	48 to 120 in.	6 to 30 in.
* Example:	IAUJ36842424	36	84	24

PLAIN METAL BACK - KICKPLATE

	STRUCTURE CODE	AVAILABLE LENGTHS in 6-inch increments	AVAILABLE HEIGHTS in 6-inch increments	AVAILABLE DEPTHS in 2-inch increments
STARTER	IDUP (L x H x Base)	24 to 48 in.	48 to 120 in.	6 to 30 in.
* Example:	IDUP36842424	36	84	24
ADDITION	IAUP (L x H x Base)	24 to 48 in.	48 to 120 in.	6 to 30 in.
* Example:	IAUP36842424	36	84	24

This is an example of coding based on the image above. Structure codes vary according to the size chosen.

E SERIES - ISLAND



EXAMPLE*:

36 in. long x 84 in. high island with a 24 in. deep base shelf on each side

PERFORATED BACK- REMOVABLE SHOE GUARD

	STRUCTURE CODE	AVAILABLE LENGTHS in 6-inch increments	AVAILABLE HEIGHTS in 6-inch increments	AVAILABLE DEPTHS in 2-inch increments
STARTER	IDPJ (L x H x Base)	24 to 48 in.	48 to 120 in.	6 to 30 in.
* Example:	IDPJ36842424	36	84	24
ADDITION	IAPJ (L x H x Base)	24 to 48 in.	48 to 120 in.	6 to 30 in.
* Example:	IAPJ36842424	36	84	24

PERFORATED BACK - KICKPLATE

	STRUCTURE CODE	AVAILABLE LENGTHS in 6-inch increments	AVAILABLE HEIGHTS in 6-inch increments	AVAILABLE DEPTHS in 2-inch increments
STARTER	IDPP (L x H x Base)	24 to 48 in.	48 to 120 in.	6 to 30 in.
* Example:	IDPP36842424	36	84	24
ADDITION	IAPP (L x H x Base)	24 to 48 in.	48 to 120 in.	6 to 30 in.
* Example:	IAPP36842424	36	84	24

This is an example of coding based on the image above. Structure codes vary according to the size chosen.

E SERIES - ISLAND



EXAMPLE*:

36 in. long x 84 in. high island with a 24 in. deep base shelf on each side

SLATWALL BACK - REMOVABLE SHOE GUARD

	STRUCTURE CODE	AVAILABLE LENGTHS in 6-inch increments	AVAILABLE HEIGHTS in 6-inch increments	AVAILABLE DEPTHS in 2-inch increments
STARTER	-	24 to 48 in.	48 to 120 in.	6 to 30 in.
* Example:	-	36	84	24
ADDITION	-	24 to 48 in.	48 to 120 in.	6 to 30 in.
* Example:	-	36	84	24

SLATWALL BACK - KICKPLATE

	STRUCTURE CODE	AVAILABLE LENGTHS in 6-inch increments	AVAILABLE HEIGHTS in 6-inch increments	AVAILABLE DEPTHS in 2-inch increments
STARTER	-	24 to 48 in.	48 to 120 in.	6 to 30 in.
* Example:	-	36	84	24
ADDITION	-	24 to 48 in.	48 to 120 in.	6 to 30 in.
* Example:	-	36	84	24

This is an example of coding based on the image above. Structure codes vary according to the size chosen.

E SERIES - END CAP



EXAMPLE*:
36 in. long x 84 in. high island with
a 24 in. deep base shelf

PLAIN METAL BACK - REMOVABLE SHOE GUARD

	STRUCTURE CODE	AVAILABLE LENGTHS in 6-inch increments	AVAILABLE HEIGHTS in 6-inch increments	AVAILABLE DEPTHS in 2-inch increments
STARTER	BDUJ (L x H x Base)	24 to 48 in.	48 to 120 in.	6 to 30 in.
* Example:	BDUJ368424	36	84	24
ADDITION	BAUJ (L x H x Base)	24 to 48 in.	48 to 120 in.	6 to 30 in.
* Example:	BAUJ368424	36	84	24

PLAIN METAL BACK - KICKPLATE

	STRUCTURE CODE	AVAILABLE LENGTHS in 6-inch increments	AVAILABLE HEIGHTS in 6-inch increments	AVAILABLE DEPTHS in 2-inch increments
STARTER	BDUP (L x H x Base)	24 to 48 in.	48 to 120 in.	6 to 30 in.
* Example:	BDUP368424	36	84	24
ADDITION	BAUP (L x H x Base)	24 to 48 in.	48 to 120 in.	6 to 30 in.
* Example:	BAUP368424	36	84	24

This is an example of coding based on the image above. Structure codes vary according to the size chosen.
See the **Accessories and Components** section for end caps

E SERIES - END CAP

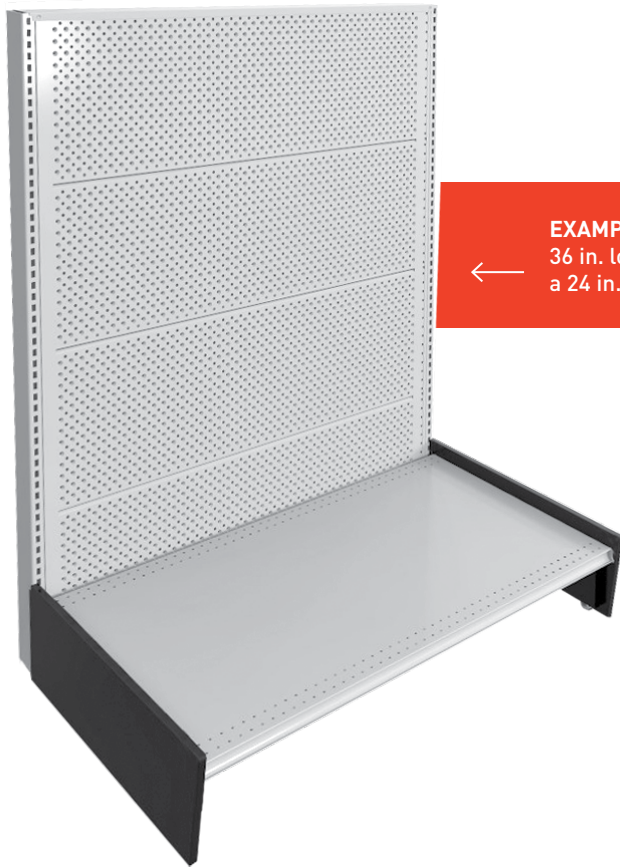

EXAMPLE*:
 ← 36 in. long x 84 in. high with
 a 24 in. deep base shelf

PERFORATED BACK - REMOVABLE SHOE GUARD

	STRUCTURE CODE	AVAILABLE LENGTHS in 6-inch increments	AVAILABLE HEIGHTS in 6-inch increments	AVAILABLE DEPTHS in 2-inch increments
STARTER	BDPJ (L x H x Base)	24 to 48 in.	48 to 120 in.	6 to 30 in.
* Example:	BDPJ368424	36	84	24
ADDITION	BAPJ (L x H x Base)	24 to 48 in.	48 to 120 in.	6 to 30 in.
* Example:	BAPJ368424	36	84	24

PERFORATED BACK - KICKPLATE

	STRUCTURE CODE	AVAILABLE LENGTHS in 6-inch increments	AVAILABLE HEIGHTS in 6-inch increments	AVAILABLE DEPTHS in 2-inch increments
STARTER	BDPP (L x H x Base)	24 to 48 in.	48 to 120 in.	6 to 30 in.
* Example:	BDPP368424	36	84	24
ADDITION	BAPP (L x H x Base)	24 to 48 in.	48 to 120 in.	6 to 30 in.
* Example:	BAPP368424	36	84	24

This is an example of coding based on the image above. Structure codes vary according to the size chosen.
 See the **Accessories and Components** section for end caps

E SERIES - END CAP



EXAMPLE*:
 ← 36 in. long x 84 in. high with
 a 24 in. deep base shelf

SLATWALL BACK - REMOVABLE SHOE GUARD

	STRUCTURE CODE	AVAILABLE LENGTHS in 6-inch increments	AVAILABLE HEIGHTS in 6-inch increments	AVAILABLE DEPTHS in 2-inch increments
STARTER	-	24 to 48 in.	48 to 120 in.	6 to 30 in.
* Example:	-	36	84	24
ADDITION	-	24 to 48 in.	48 to 120 in.	6 to 30 in.
* Example:	-	36	84	24

SLATWALL BACK - KICKPLATE

	STRUCTURE CODE	AVAILABLE LENGTHS in 6-inch increments	AVAILABLE HEIGHTS in 6-inch increments	AVAILABLE DEPTHS in 2-inch increments
STARTER	-	24 to 48 in.	48 to 120 in.	6 to 30 in.
* Example:	-	36	84	24
ADDITION	-	24 to 48 in.	48 to 120 in.	6 to 30 in.
* Example:	-	36	84	24

This is an example of coding based on the image above. Structure codes vary according to the size chosen.
 See the **Accessories and Components** section for end caps

S SERIES - WALL



EXAMPLE*:
36 in. long x 84 in. high wall with
a 24 in. deep base shelf

SOLID MASONITE BACK - SHOE GUARD

	STRUCTURE CODE	AVAILABLE LENGTHS in 6-inch increments	AVAILABLE HEIGHTS in 6-inch increments	AVAILABLE DEPTHS in 2-inch increments
STARTER	SMBDUJ3B (L x H x Base)	24 to 48 in.	48 to 120 in.	6 to 30 in.
* Example:	SMBDUJ3B368424	36	84	24
ADDITION	SMBAUJ3B (L x H x Base)	24 to 48 in.	48 to 120 in.	6 to 30 in.
* Example:	SMBAUJ3B368424	36	84	24
BASE SHELF HEIGHT (2 heights available): 5 3/4 in. H <i>Low base</i> (from floor to shelf) 7 1/4 in. H <i>High base</i> (from floor to shelf)				

SOLID MASONITE BACK - KICKPLATE

	STRUCTURE CODE	AVAILABLE LENGTHS in 6-inch increments	AVAILABLE HEIGHTS in 6-inch increments	AVAILABLE DEPTHS in 2-inch increments
STARTER	SMBDPJ3B (L x H x Base)	24 to 48 in.	48 to 120 in.	6 to 30 in.
* Example:	SMBDPJ3B368424	36	84	24
ADDITION	SMBAUP3B (L x H x Base)	24 to 48 in.	48 to 120 in.	6 to 30 in.
* Example:	SMBAUP3B368424	36	84	24
BASE SHELF HEIGHT (2 heights available): 5 3/4 in. H <i>Low base</i> (from floor to shelf) 7 1/4 in. H <i>High base</i> (from floor to shelf)				

This is an example of coding based on the image above. Structure codes vary according to the size chosen.

S SERIES - WALL

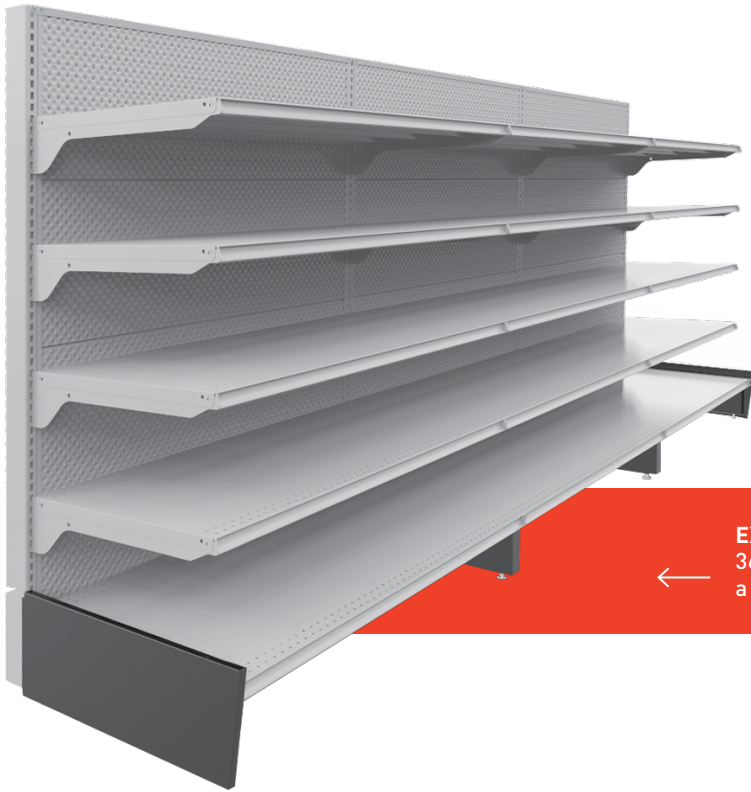

EXAMPLE*:
36 in. long x 84 in. high wall with
a 24 in. deep base shelf

PERFORATED MASONITE BACK - SHOE GUARD

	STRUCTURE CODE	AVAILABLE LENGTHS in 6-inch increments	AVAILABLE HEIGHTS in 6-inch increments	AVAILABLE DEPTHS in 2-inch increments
STARTER	SMBDPJ3B (L x H x Base)	24 to 48 in.	48 to 120 in.	6 to 30 in.
* Example:	SMBDPJ3B368424	36	84	24
ADDITION	SMBAPJ3B (L x H x Base)	24 to 48 in.	48 to 120 in.	6 to 30 in.
* Example:	SMBAPJ3B368424	36	84	24
BASE SHELF HEIGHT (2 heights available): 5 3/4 in. H <i>Low base</i> (from floor to shelf) 7 1/4 in. H <i>High base</i> (from floor to shelf)				

PERFORATED MASONITE BACK - KICKPLATE

	STRUCTURE CODE	AVAILABLE LENGTHS in 6-inch increments	AVAILABLE HEIGHTS in 6-inch increments	AVAILABLE DEPTHS in 2-inch increments
STARTER	SMBDPP3B (L x H x Base)	24 to 48 in.	48 to 96 in.	10 to 30 in.
* Example:	SMBDPP3B368424	36	84	24
ADDITION	SMBAPP3B (L x H x Base)	24 to 48 in.	48 to 96 in.	10 to 30 in.
* Example:	SMBAPP3B368424	36	84	24
BASE SHELF HEIGHT (2 heights available): 5 3/4 in. H <i>Low base</i> (from floor to shelf) 7 1/4 in. H <i>High base</i> (from floor to shelf)				

This is an example of coding based on the image above. Structure codes vary according to the size chosen.

S SERIES - WALL



EXAMPLE*:
36 in. long x 84 in. high wall with
a 24 in. deep base shelf

SLATWALL BACK - SHOE GUARD

	STRUCTURE CODE	AVAILABLE LENGTHS in 6-inch increments	AVAILABLE HEIGHTS in 6-inch increments	AVAILABLE DEPTHS in 2-inch increments
STARTER	-	24 to 48 in.	48 to 120 in.	6 to 30 in.
* Example:	-	36	84	24
ADDITION	-	24 to 48 in.	48 to 120 in.	6 to 30 in.
* Example:	-	36	84	24
BASE SHELF HEIGHT (2 heights available): 5 3/4 in. H <i>Low base</i> (from floor to shelf) 7 1/4 in. H <i>High base</i> (from floor to shelf)				

SLATWALL BACK - KICKPLATE

	STRUCTURE CODE	AVAILABLE LENGTHS in 6-inch increments	AVAILABLE HEIGHTS in 6-inch increments	AVAILABLE DEPTHS in 2-inch increments
STARTER	SMSDIP3B (L x H x Base)	24 to 48 in.	48 to 96 in.	10 to 30 in.
* Example:	SMSDIP3B36842424B	36	84	24
ADDITION	SMSAIP3B (L x H x Base)	24 to 48 in.	48 to 96 in.	10 to 30 in.
* Example:	SMSAIP3B36842424B	36	84	24
BASE SHELF HEIGHT (2 heights available): 5 3/4 in. H <i>Low base</i> (from floor to shelf) 7 1/4 in. H <i>High base</i> (from floor to shelf)				

This is an example of coding based on the image above. Structure codes vary according to the size chosen.

S SERIES - ISLAND

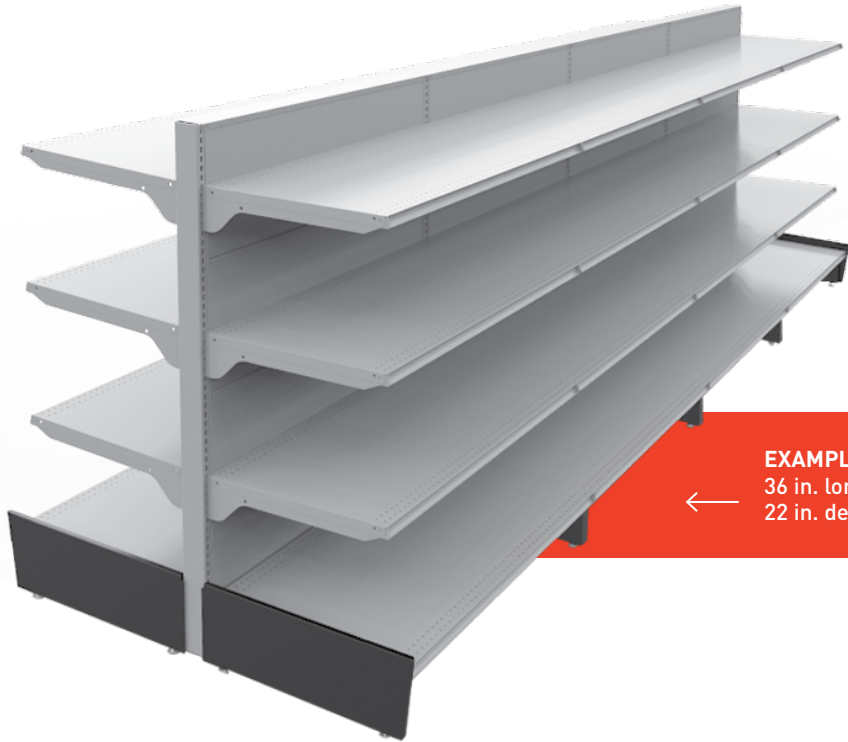

EXAMPLE*:
 ← 36 in. long x 84 in. high island with a
 22 in. deep base shelf on each side

SOLID MASONITE BACK - SHOE GUARD

	STRUCTURE CODE	AVAILABLE LENGTHS in 6-inch increments	AVAILABLE HEIGHTS in 6-inch increments	AVAILABLE DEPTHS in 2-inch increments
STARTER	SIBDUJ3B (L x H x Base)	24 to 48 in.	48 to 120 in.	6 to 30 in.
* Example:	SIBDUJ3B36842222	36	84	22
ADDITION	SIBAUJ3B (L x H x Base)	24 to 48 in.	48 to 120 in.	6 to 30 in.
* Example:	SIBAUJ3B36842222	36	84	22
BASE SHELF HEIGHT (2 heights available): 5 3/4 in. H <i>Low base</i> (from floor to shelf) 7 1/4 in. H <i>High base</i> (from floor to shelf)				

SOLID MASONITE BACK - KICKPLATE

	STRUCTURE CODE	AVAILABLE LENGTHS in 6-inch increments	AVAILABLE HEIGHTS in 6-inch increments	AVAILABLE DEPTHS in 2-inch increments
STARTER	SIBDUP3B (L x H x Base)	24 to 48 in.	48 to 96 in.	10 to 30 in.
* Example:	SIBDUP3B36842222	36	84	22
ADDITION	SIBAU3B (L x H x Base)	24 to 48 in.	48 to 96 in.	10 to 30 in.
* Example:	SIBAU3B36842222	36	84	22
BASE SHELF HEIGHT (2 heights available): 5 3/4 in. H <i>Low base</i> (from floor to shelf) 7 1/4 in. H <i>High base</i> (from floor to shelf)				

This is an example of coding based on the image above. Structure codes vary according to the size chosen.

S SERIES - ISLAND



EXAMPLE*:
 ← 36 in. long x 84 in. high island with a 22 in. deep base shelf on each side

PERFORATED MASONITE BACK - SHOE GUARD

	STRUCTURE CODE	AVAILABLE LENGTHS in 6-inch increments	AVAILABLE HEIGHTS in 6-inch increments	AVAILABLE DEPTHS in 2-inch increments
STARTER	SIBDPJ3B (L x H x Base)	24 to 48 in.	48 to 96 in.	10 to 30 in.
* Example:	SIBDPJ3B36842222	36	84	22
ADDITION	SIBAPJ3B (L x H x Base)	24 to 48 in.	48 to 96 in.	10 to 30 in.
* Example:	SIBAPJ3B36842222	36	84	22
BASE SHELF HEIGHT (2 heights available): 5 3/4 in. H <i>Low base</i> (from floor to shelf) 7 1/4 in. H <i>High base</i> (from floor to shelf)				

PERFORATED MASONITE BACK - KICKPLATE

	STRUCTURE CODE	AVAILABLE LENGTHS in 6-inch increments	AVAILABLE HEIGHTS in 6-inch increments	AVAILABLE DEPTHS in 2-inch increments
STARTER	SIBDPP3B (L x H x Base)	24 to 48 in.	48 to 96 in.	10 to 30 in.
* Example:	SIBDPP3B36842222	36	84	22
ADDITION	SIBAPP3B (L x H x Base)	24 to 48 in.	48 to 96 in.	10 to 30 in.
* Example:	SIBAPP3B36842222	36	84	22
BASE SHELF HEIGHT (2 heights available): 5 3/4 in. H <i>Low base</i> (from floor to shelf) 7 1/4 in. H <i>High base</i> (from floor to shelf)				

This is an example of coding based on the image above. Structure codes vary according to the size chosen.

S SERIES - ISLAND



← **EXAMPLE*:**
36 in. long x 84 in. high island with a
24 in. deep base shelf on each side

SLATWALL BACK - KICKPLATE

	STRUCTURE CODE	AVAILABLE LENGTHS in 6-inch increments	AVAILABLE HEIGHTS in 6-inch increments	AVAILABLE DEPTHS in 2-inch increments
STARTER	SISDIP3B (L x H x Base)	24 to 48 in.	48 to 96 in.	10 to 30 in.
* Example:	SISDIP3B36842424B	36	84	24
ADDITION	SISAIP3B (L x H x Base)	24 to 48 in.	48 to 96 in.	10 to 30 in.
* Example:	SISAIP3B36842424B	36	84	24
BASE SHELF HEIGHT (2 heights available): 5 3/4 in. H <i>Low base</i> (from floor to shelf) 7 1/4 in. H <i>High base</i> (from floor to shelf)				

This is an example of coding based on the image above. Structure codes vary according to the size chosen.

S SERIES - END CAP



SOLID MASONITE BACK - SHOE GUARD

	STRUCTURE CODE	AVAILABLE LENGTHS in 6-inch increments	AVAILABLE HEIGHTS in 6-inch increments	AVAILABLE DEPTHS in 2-inch increments
STARTER	SBBDUJ3H (L x H x Base)	24 to 48 in.	48 to 96 in.	10 to 30 in.
* Example:	SBBDUJ3H369624	36	96	24
ADDITION	SBBAUJ3H (L x H x Base)	24 to 48 in.	48 to 96 in.	10 to 30 in.
* Example:	SBBAUJ3H369624	36	96	24
BASE SHELF HEIGHT (2 heights available): 5 3/4 in. H <i>Low base</i> (from floor to shelf) 7 1/4 in. H <i>High base</i> (from floor to shelf)				

SOLID MASONITE BACK - KICKPLATE

	STRUCTURE CODE	AVAILABLE LENGTHS in 6-inch increments	AVAILABLE HEIGHTS in 6-inch increments	AVAILABLE DEPTHS in 2-inch increments
STARTER	SBBDUP3H (L x H x Base)	24 to 48 in.	48 to 96 in.	10 to 30 in.
* Example:	SBBDUP3H369624	36	96	24
ADDITION	SBBAUP3H (L x H x Base)	24 to 48 in.	48 to 96 in.	10 to 30 in.
* Example:	SBBAUP3H369624	36	96	24
BASE SHELF HEIGHT (2 heights available): 5 3/4 in. H <i>Low base</i> (from floor to shelf) 7 1/4 in. H <i>High base</i> (from floor to shelf)				

This is an example of coding based on the image above. Structure codes vary according to the size chosen.
See the **Accessories and Components** section for end caps

S SERIES - END CAP

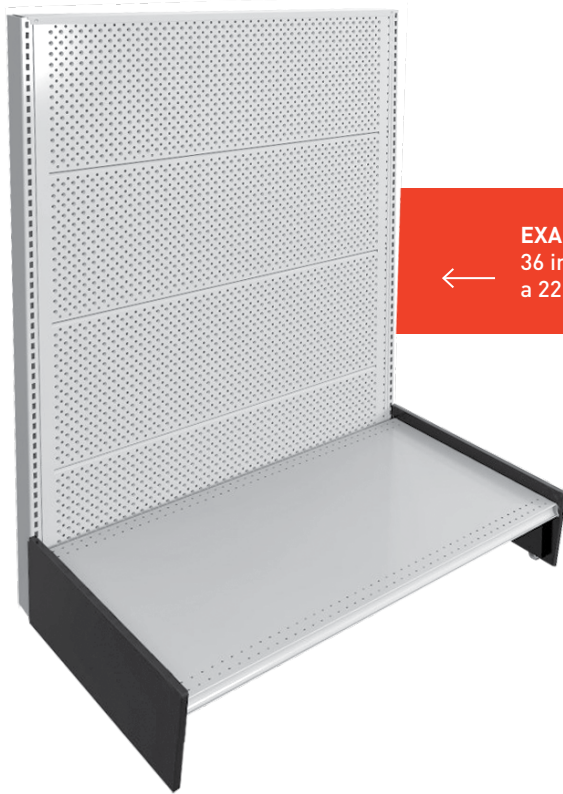

EXAMPLE*:

36 in. long x 96 in. high island with a 22 in. deep base shelf

PERFORATED MASONITE BACK - SHOE GUARD

	STRUCTURE CODE	AVAILABLE LENGTHS in 6-inch increments	AVAILABLE HEIGHTS in 6-inch increments	AVAILABLE DEPTHS in 2-inch increments
STARTER	SBDPJ3H (L x H x Base)	24 to 48 in.	48 to 96 in.	10 to 30 in.
* Example:	SBDPJ3H369624	36	96	24
ADDITION	SBBAPJ3H (L x H x Base)	24 to 48 in.	48 to 96 in.	10 to 30 in.
* Example:	SBBAPJ3H369624	36	96	24
BASE SHELF HEIGHT (2 heights available): 5 3/4 in. H <i>Low base</i> (from floor to shelf) 7 1/4 in. H <i>High base</i> (from floor to shelf)				

PERFORATED MASONITE BACK - KICKPLATE

	STRUCTURE CODE	AVAILABLE LENGTHS in 6-inch increments	AVAILABLE HEIGHTS in 6-inch increments	AVAILABLE DEPTHS in 2-inch increments
STARTER	SBDPP3H (L x H x Base)	24 to 48 in.	48 to 96 in.	10 to 30 in.
* Example:	SBDPP3H369624	36	96	24
ADDITION	SBBAPP3H (L x H x Base)	24 to 48 in.	48 to 96 in.	10 to 30 in.
* Example:	SBBAPP3H369624	36	96	24
BASE SHELF HEIGHT (2 heights available): 5 3/4 in. H <i>Low base</i> (from floor to shelf) 7 1/4 in. H <i>High base</i> (from floor to shelf)				

*This is an example of coding based on the image above. Structure codes vary according to the size chosen. See the **Accessories and Components** section for end caps*

S SERIES - END CAP



EXAMPLE*:
 ← 36 in. long x 90 in. high island with
 a 22 in. deep base shelf

SLATWALL BACK - SHOE GUARD

	STRUCTURE CODE	AVAILABLE LENGTHS in 6-inch increments	AVAILABLE HEIGHTS in 6-inch increments	AVAILABLE DEPTHS in 2-inch increments
STARTER	-	24 to 48 in.	48 to 96 in.	10 to 30 in.
* Example:	-	36	96	24
ADDITION	-	24 to 48 in.	48 to 96 in.	10 to 30 in.
* Example:	-	36	96	24

BASE SHELF HEIGHT (2 heights available): 5 3/4 in. H *Low base* (from floor to shelf)
 7 1/4 in. H *High base* (from floor to shelf)

SLATWALL BACK - KICKPLATE

	STRUCTURE CODE	AVAILABLE LENGTHS in 6-inch increments	AVAILABLE HEIGHTS in 6-inch increments	AVAILABLE DEPTHS in 2-inch increments
STARTER	SBSDIP3B (L x H x Base)	24 to 48 in.	48 to 96 in.	10 to 30 in.
* Example:	SBSDIP3B369024	36	96	24
ADDITION	SBSAIP3B (L x H x Base)	24 to 48 in.	48 to 96 in.	10 to 30 in.
* Example:	SBSAIP3B369024	36	96	24

BASE SHELF HEIGHT (2 heights available): 5 3/4 in. H *Low base* (from floor to shelf)
 7 1/4 in. H *High base* (from floor to shelf)

This is an example of coding based on the image above. Structure codes vary according to the size chosen.
 See the **Accessories and Components** section for end caps

C SERIES - WALL



DIMENSIONS

MEASURE (IN.)

AVAILABLE HEIGHTS 36 - 42 - 48 - 54 - 60 - 66 - 72

AVAILABLE WIDTHS 24 - 30 - 36 - 48

AVAILABLE BASE DEPTHS 8 - 10 - 12 - 14 - 16

AVAILABLE SHELF DEPTHS 8 - 10 - 12 - 14 - 16

OPTION: with or without shelves

BACK OPTION: masonite (plain or perforated), wire mesh and slatwall

C SERIES - ISLAND (END CAP AND PANEL OPTIONAL)



← Plain back island with base, slatwall panel and accessories (optional end cap or panel)

DIMENSIONS

MEASURE (IN.)

AVAILABLE HEIGHTS	36 - 42 - 48 - 54 - 60 - 66 - 72
AVAILABLE WIDTHS	24 - 30 - 36 - 48
AVAILABLE BASE DEPTHS	6 - 8 - 10 - 12 - 14 - 16
AVAILABLE SHELF DEPTHS	6 - 8 - 10 - 12 - 14 - 16

OPTION: with or without shelves

OPTION: on wheels or levelers

BACK OPTION: masonite (plain or perforated), wire mesh and slatwall

C SERIES - SEVERAL POSSIBLE CONFIGURATIONS



← Slatwall island with base, end cap and various accessories



Island with various backs, end caps and accessories →

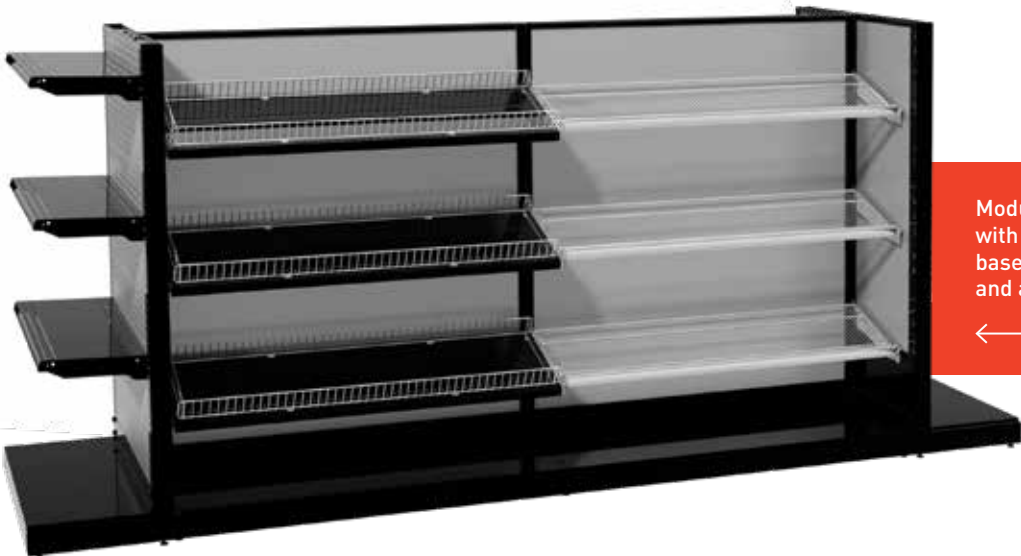

Modular island with various backs, bases, island ends and accessories ←

CABINETS

METAL CABINET WITH GLASS DOORS SHELVES AND LOCK NOT INCLUDED

CODE	MEASURE (IN.)	
022-03-4830	48 L x 30 H x 12 P	With metal top
022-03-4847	48 L x 47 H x 16 P	With metal top
022-04-4830	48 L x 30 H x 16 P	With metal top



METAL CABINET WITH GLASS DOORS AND PERFORATED SIDES - SHELVES AND LOCK NOT INCLUDED

CODE	MEASURE (IN.)	
000-00-0000	48 L x 47 H x 16 P	With metal top and perforated sides for ventilation - to lock up pesticides and other dangerous products
000-00-0000	48 L x 37 H x 16 P	
000-00-0000	48 L x 30 H x 16 P	
000-00-0000	48 L x 16 H x 16 P	



LOCK

CODE	DESCRIPTION
022-03-0000	Sliding lock for metal cabinet with glass doors TDK7



WIRE MESH DOORS FOR ETALEX STRUCTURE

FRAME WITH DOORS

SHELF, BRACKET AND STRUCTURE NOT INCLUDED

CODE	MEASURE (IN.)
------	---------------

030-30-3048	48 L x 30 H
030-30-3648	48 L x 36 H
030-30-5248	48 L x 52 H
030-30-6248	48 L x 62 H
030-30-7648	48 L x 76 H

LEFT SIDE PANEL

CODE	MEASURE (IN.)	
------	---------------	--

000-00-0000	16 L x 30 H	For shelf with label moulding
000-00-0000	16 L x 36 H	For shelf with label moulding
000-00-0000	16 L x 52 H	For shelf with label moulding
000-00-0000	16 L x 62 H	For shelf with label moulding
000-00-0000	16 L x 76 H	For shelf with label moulding
000-00-0000	16 1/2 L x 30 H	
000-00-0000	16 1/2 L x 36 H	
000-00-0000	16 1/2 L x 52 H	
000-00-0000	16 1/2 L x 62 H	
000-00-0000	16 1/2 L x 76 H	

RIGHT SIDE PANEL

CODE	MEASURE (IN.)	
------	---------------	--

000-00-0000	16 L x 30 H	For shelf with label moulding
000-00-0000	16 L x 36 H	For shelf with label moulding
000-00-0000	16 L x 52 H	For shelf with label moulding
000-00-0000	16 L x 62 H	For shelf with label moulding
000-00-0000	16 L x 76 H	For shelf with label moulding
000-00-0000	16 1/2 L x 30 H	
000-00-0000	16 1/2 L x 36 H	
000-00-0000	16 1/2 L x 52 H	
000-00-0000	16 1/2 L x 62 H	
000-00-0000	16 1/2 L x 76 H	

CIRCUIT BREAKER DISPLAY

WITH ACRYLIC DOOR

CODE	DESCRIPTION
------	-------------

030370848A700	48 L x 8 H 13 spaces of 3 5/8 in. inside
---------------	---

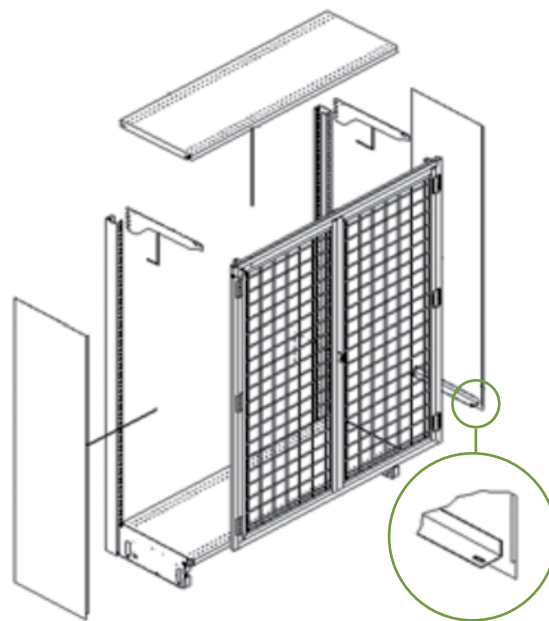

DISPLAYS

WIRE SPOOL DISPLAY - SINGLE

CODE	MEASURE (IN.)
PRF-01-3008	8 x 30
PRF-01-3608	8 x 36
PRF-01-4808	8 x 48
PRF-01-3012	12 x 30
PRF-01-3612	12 x 36
PRF-01-4812	12 x 48

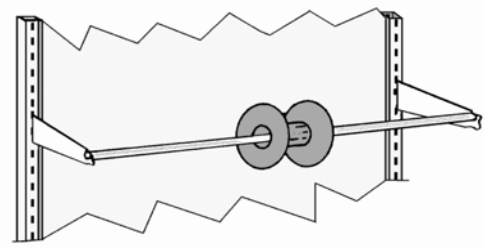

WIRE SPOOL DISPLAY - DOUBLE

CODE	MEASURE (IN.)
PRF-02-3012	12 x 30
PRF-02-3612	12 x 36
PRF-02-4812	12 x 48
PRF-02-4816	16 x 48

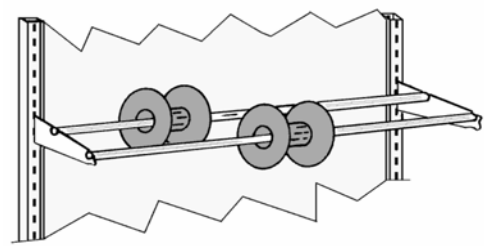

BRACKET FOR WIRE SPOOL DISPLAY

CODE	MEASURE (IN.)	
006-10-G0008	8	Left
006-10-G0012	12	Left
006-10-G0016	16	Left
006-10-D0008	8	Right
006-10-D0012	12	Right
006-10-D0016	16	Right

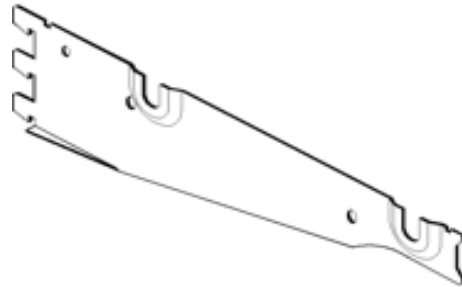

ROD FOR WIRE SPOOL DISPLAY - CHROME FINISH

CODE	MEASURE (IN.)
016-22-0030	30
016-22-0036	36
016-22-0048	48
016-22-0056	56



DISPLAYS

SPOOL DISPLAY - HEAVY DUTY

CODE	MEASURE (IN.)	
016-21-0003	3 tubes	
016-21-0004	4 tubes	

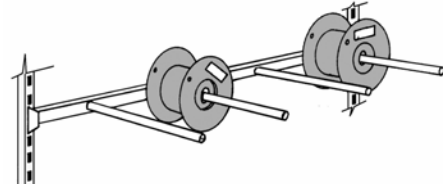

SPOOL DISPLAY RODS - 5/8 in.

CODE	MEASURE (IN.)	
016-21-0003A	5/8	3 rods
016-21-0004A	5/8	4 rods
016-21-0005A	5/8	5 rods

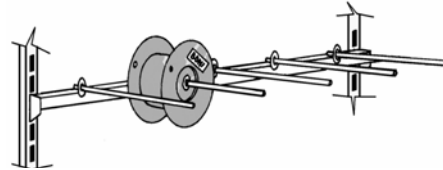

SPOOL DISPLAY BACKING WALL NOT INCLUDED

CODE	MEASURE (IN.)	
030-18-0004	73	Upper center
030-18-0003	73	Upper end
030-04-0048	48	Crossbar
030-18-0004	5/8 x 29 1/2	Tubing
030-18-0003	73	Tubing bracket

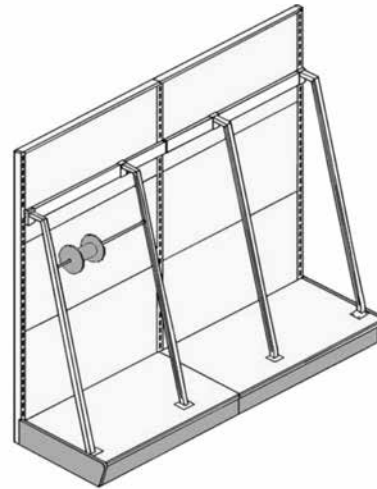

METER AND WINDER CROSSBAR

CODE	MEASURE (IN.)	
016-21-0003A		For meter and spool 48 in. long
016-21-0048	20 x 48	With sliding base for meter only
016-21-0096	20 x 96	With sliding base for meter only

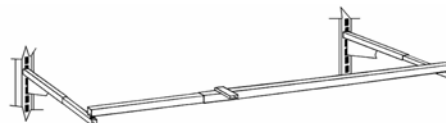
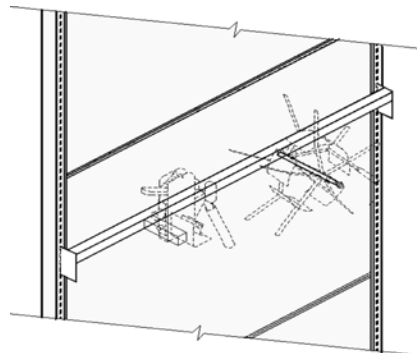

DISPLAYS

METER

CODE

016-21-0000 Metric meter model #1420 for wires

016-21-0000A Metric meter model #1410 for wires



METER

CODE

SPECIAL ORDER

016-21-0000B Metric meter model #1430 for cords



CUTTER

CODE

016-21-0100



SPOOL

CODE

016-21-0001 Model 99



DISPLAYS

HEATING KICKPLATE DISPLAY

CODE	MEASURE (IN.)	
030-26-4816	16 x 48	With 5 fixed dividers
030-26-4820	20 x 48	With 5 fixed dividers
030-27-4816	16 x 48	Without dividers

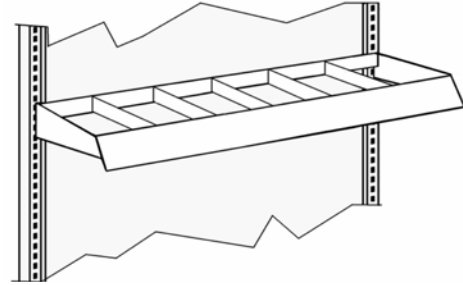

SINK OR RANGE HOOD FAN DISPLAY

CODE	MEASURE (IN.)	
Traverse		
030-04-0036	4 x 36	
030-04-0048	4 x 48	
Bracket for sink		
006-13-0020	20	Right bracket
006-13-0021	20	Left bracket
Bracket for range hood fan		
023-28-0001		Right bracket
023-28-0011		Left bracket

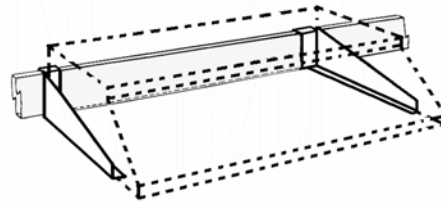
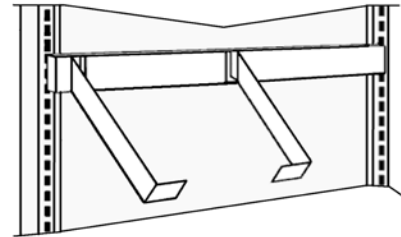

CEILING LIGHT AND FAN DISPLAY

FIXED ON ETALEX STRUCTURE

SPECIAL ORDER

50 lb per square foot capacity

WARNING! Under no circumstance can a person walk on top of the display

CEILING-MOUNTED

SPECIAL ORDER

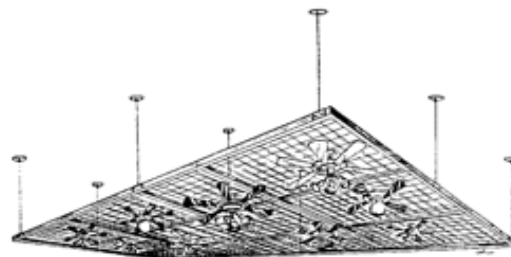

LIGHTING DISPLAY FOR GONDOLA STRUCTURE

Each set includes the frames, the 14 x 14 in. panels (matched, either with slits, plain and with octagonal hole) and those of finishing. Melamine finish.

UPPER PANEL - SINGLE (1)

CODE	MEASURE (IN.)	
PRL-01-3616	36 L x 16 H	2 panels wide
PRL-01-4816	48 L x 16 H	3 panels wide

UPPER PANEL - DOUBLE (2)

CODE	MEASURE (IN.)	
PRL-02-3630	36 L x 30 H	2 panels wide
PRL-02-4830	48 L x 30 H	3 panels wide

UPPER PANEL - TRIPLE (3)

CODE	MEASURE (IN.)	
PRL-03-3648	36 L x 48 H	2 panels wide
PRL-03-4848	48 L x 48 H	3 panels wide

UPPER PANEL - QUADRUPLE (4)

CODE	MEASURE (IN.)	
PRL-04-3663	36 L x 63 H	2 panels wide
PRL-04-4863	48 L x 63 H	3 panels wide



ACCESSORY

CODE	MEASURE (IN.)	
	14 x 14 x 5/8	Panel with 3 slots
	14 x 14 x 5/8	Panel with octagonal holes
	14 x 14 x 5/8	Panel with finished fields

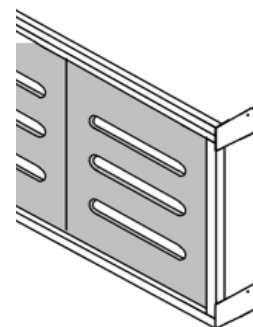

BRACKET FOR LIGHTING DISPLAY

CODE	MEASURE (IN.)	
039-D2-0001	1 1/2 L x 4 H x 2 P	Right
039-G2-0001	1 1/2 L x 4 H x 2 P	Left

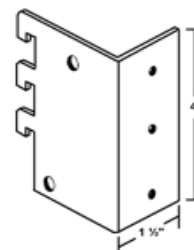

ALUMINIUM SLATWALL PANEL SYSTEM

Adapted for store gondolas and/or can be integrated in our heavy racking system.

SPECIAL ORDER



TOOL SECTION ACCESSORIES

DRILL DISPLAY

CODE	MEASURE (IN.)	
495-15-02J05	2 1/2 x 5	With 5/16 in. rod at 45° angle

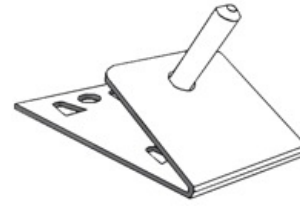

DIVIDER

CODE	MEASURE (IN.)	
Back stopper for perforated steel panel		
495-12-1045R	45 7/8 L x 10 H	For divider with hooks and slots
For divider box with hooks for perforated steel panel		
028-02-1316AD	16 x 1 1/4 x 10	Right
028-02-1321AD	21 x 1 1/4 x 10	Right
028-02-1316AG	16 x 1 1/4 x 10	Left
028-02-1321AG	21 x 1 1/4 x 10	Left
For divider box with clamps for perforated steel panel		
495-12-1045R	1 x 3 x 12	

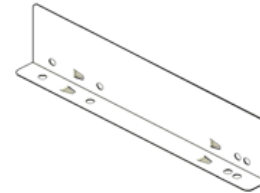
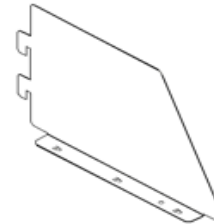
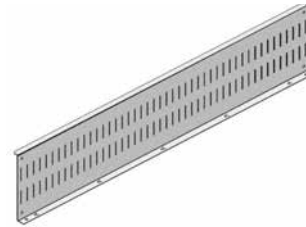

TOOL SECTION ACCESSORIES

SLEDGEHAMMER DISPLAY

CODE

410-01-0112 For slatwall or perforated panel 10 in. long x 5 3/16 in. back / 3 1/2 in. front, with flip-scan label holder rod with 2 3/4 in. space between the 2 sides

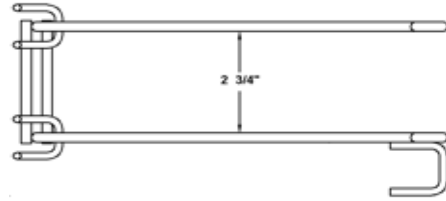

AXE AND HAMMER DISPLAY

CODE

420-01-1112 For slatwall or perforated panel 10 in. long x 5 3/16 in. back / 3 1/2 in. front, with flip-scan label holder rod with 1 3/4 in. space between the 2 sides

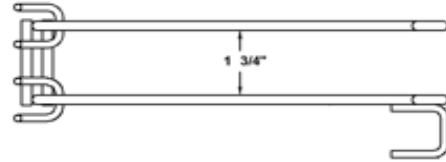

SLEDGEHAMMER DISPLAY (NOT FIXED)

CODE

MEASURE (IN.)

030-01-4809	48 L x 9 P	Single	1
030-02-4816	48 L x 16 P	Double	2
M11100562A501	48 L x 18 P	Double in two levels	3

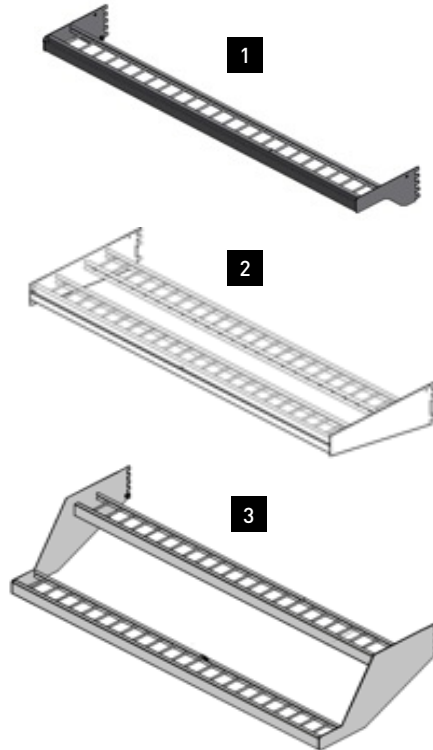

TOOL SECTION DISPLAYS

TIERED SAW BLADE DISPLAY

CODE	MEASURE (IN.)	
018-03-0036	36	3 levels
018-04-0036	36	4 levels
018-05-0036	36	5 levels
018-03-0048	48	3 levels
018-04-0048	48	4 levels
018-05-0048	48	5 levels

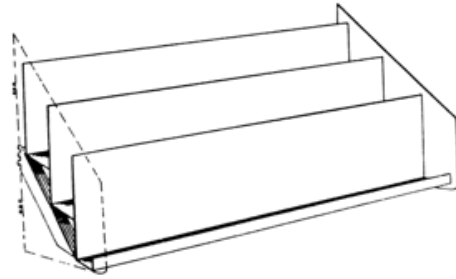

TIERED SAW BLADE DISPLAY END

CODE	
019-G3-0002	Left 3 levels
019-G4-0002	Left 4 levels
019-G5-0002	Left 5 levels
019-D3-0002	Right 3 levels
019-D4-0002	Right 4 levels
019-D5-0002	Right 5 levels

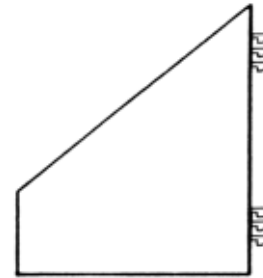

TOOL SECTION ACCESSORIES

CROSSBAR - 1 x 2 x 48 in.

CODE	MEASURE (IN.)
030-04-0124K	24
030-04-0130K	30
030-04-0136K	36
030-04-0148K	48

ACCESSORIES FOR CROSSBAR - 1 x 2 x 48 in.

CODE	MEASURE (IN.)		
006-22-0010	10	Bracket with 1 rod	1
006-22-0014	14	Bracket with 1 rod	1
006-23-0010	10	Bracket with 2 rods	2
006-23-0014	14	Bracket with 2 rods	2
006-27-0010	10	Bracket for tools	3
006-27-0014	14	Bracket for tools	3
006-28-0001	10	Bracket for saws	4
410010018A	18	Round bracket for drapes	5
016-41-0006	6	Hook for tools	6
016-41-0008	8	Hook for tools	6
016-41-0012	12	Hook for tools	6

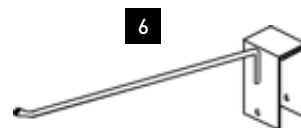
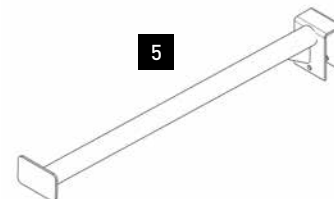
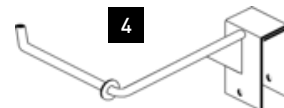
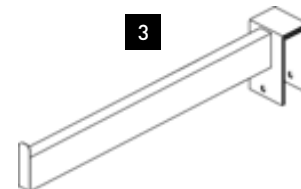
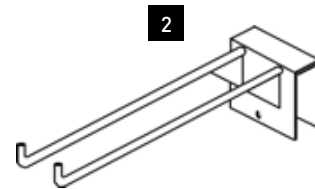
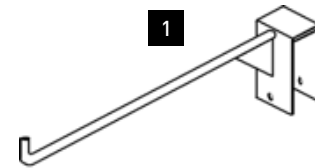
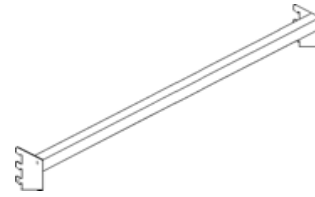

TOOL SECTION DISPLAYS

SLIDING PERFORATED PANEL

CODE	MEASURE (IN.)	
	24 x 54	43 1/2 in. high frame
	24 x 60	49 1/2 in. high frame
	24 x 66	55 1/2 in. high frame
	24 x 72	62 1/2 in. high frame
	24 x 84	73 1/2 in. high frame

Available for 48 in. wide section, 1 panel 24 in. wide sliding on a 48 in. long track

The top frame/bracket has a depth of 16 in., the track can be placed in any position

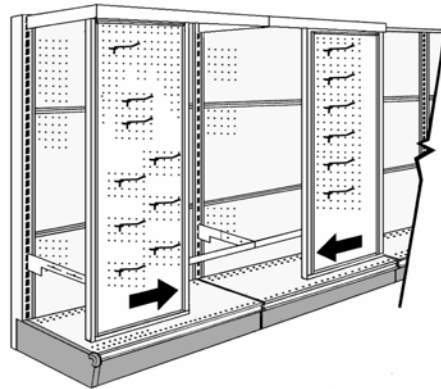

DOOR OR SAMPLE PANEL DISPLAY

CODE	MEASURE (IN.)	
For wall structure - 96 in. high		
031-03-0036	36	With brackets for 12 doors
031-03-0048	48	With brackets for 16 doors
Wall mounted		
031-03-0136	36	With brackets for 12 doors
031-03-0148	48	With brackets for 16 doors



PRECUT PANEL DISPLAY

CODE	MEASURE (IN.)	
031-12-4848	22 1/2 x 48	With 6 dividers

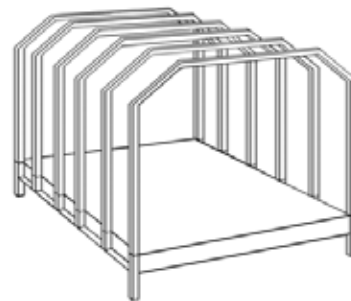

TOOL SECTION DISPLAYS

CROSSBAR AND DIVIDER FOR COUNTER TOP

CODE	MEASURE (IN.)
Divider for counter top	
030-19-0029	1 x 1 x 29
Divider crossbar	
030-19-0048	1 1/4 x 1 1/4 x 48
030-19-0096	1 1/4 x 1 1/4 x 96

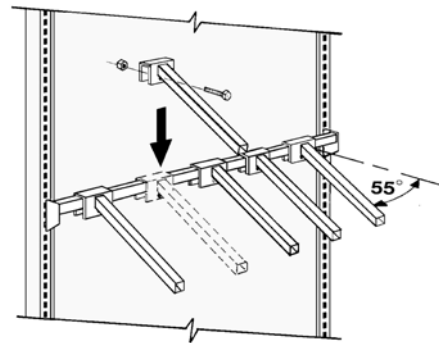

LENGTHY MATERIAL DISPLAY

CODE	MEASURE (IN.)
Frame	
030-09-4816	16 x 48
030-09-4818	18 x 48
030-09-4820	20 x 48
Divider	
030-09-0016	16
030-09-0018	18
030-09-0020	20

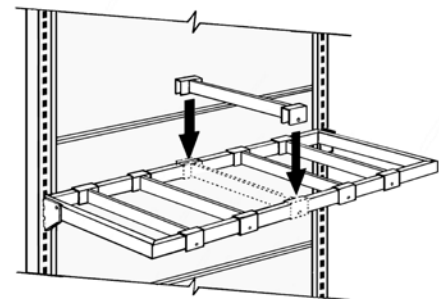

LENGTHY MATERIAL DISPLAY ACCESSORIES

CODE	MEASURE (IN.)
Crossbar	
030-07-0036	1 x 1 x 36
030-07-0048	1 x 1 x 48
Divider	
016-25-0016	16

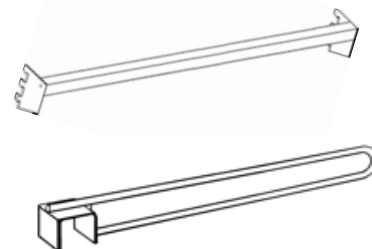

DISPLAY FOR STUDS

CODE	MEASURE (IN.)	
Frame		
PRG-00-0030	30 L x 10 P	With 14 dividers
PRG-00-0036	36 L x 10 P	With 16 dividers
PRG-00-0048	48 L x 10 P	With 20 dividers
Divider		
023-04-0001		

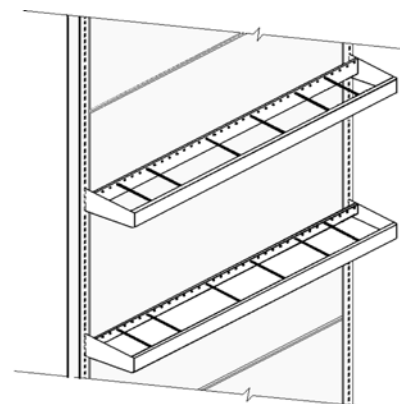

DISPLAYS

BELT DISPLAY

WALL PANEL AND HOOKS NOT INCLUDED

CODE	MEASURE (IN.)
Crossbar with brackets	
PRC-00-3001	1 x 30
PRC-00-3601	1 x 36
PRC-00-4801	1 x 48
PRC-00-3004	4 x 30
PRC-00-3604	4 x 36
PRC-00-4804	4 x 48
PRC-00-3008	8 x 30
PRC-00-3608	8 x 36
PRC-00-4808	8 x 48
PRC-00-3012	12 x 30
PRC-00-3612	12 x 36
PRC-00-4812	12 x 48
PRC-00-3016	16 x 30
PRC-00-3616	16 x 36
PRC-00-4816	16 x 48

4 in. hook

016-40-0004	4	Single (unit)	
016-32-2004U	4	Single scan 4 in. (unit)	SPECIAL ORDER

Label holder
sold separately

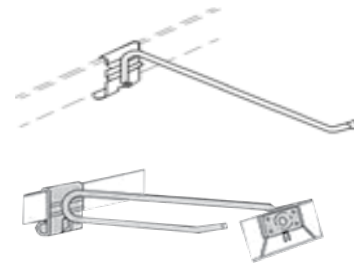
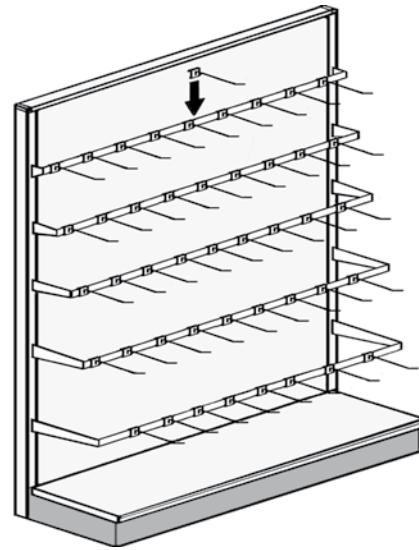

VINYL ROLL DISPLAY

CODE	MEASURE (IN.)	
031-06-0056	56 L x 8 P	Rod not included (see below)



VINYL ROLL DISPLAY ROD - CHROME FINISH

CODE	MEASURE (IN.)
016-22-0056	56

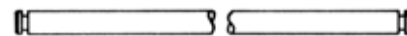

SAND PAPER DISPLAY

CODE	MEASURE (IN.)	
030-11-0030	30	9 spaces
030-11-0048	48	15 spaces

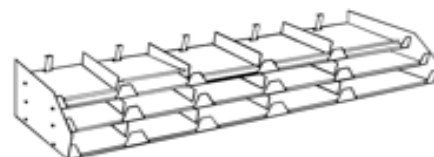

TOOL SECTION ACCESSORIES

LOCKER SHELF

CODE	MEASURE (IN.)
023-01-3608	8 x 36
023-01-3610	10 x 36
023-01-3612	12 x 36
023-01-3614	14 x 36
023-01-3616	16 x 36
023-01-4808	8 x 48
023-01-4810	10 x 48
023-01-4812	12 x 48
023-01-4814	14 x 48
023-01-4816	16 x 48

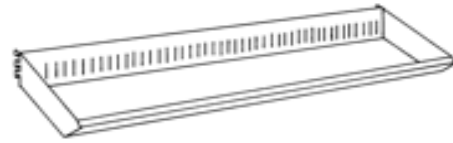

LOCKER SHELF

CODE	MEASURE (IN.)	
023-01-0008	8 (6 7/8)	No slots for subdividers
023-01-0010	10 (8 7/8)	
023-01-0012	12 (10 7/8)	
023-01-0014	14 (12 7/8)	
023-01-0016	16 (14 7/8)	

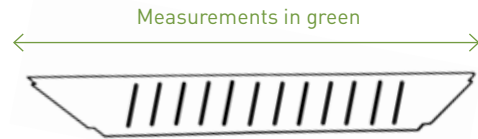

LOCKER SHELF SUBDIVIDER

CODE	MEASURE (IN.)
023-01-0004	4
023-01-0006	6



NAIL SHELF

CODE	MEASURE (IN.)	
023-02-0036	9 x 16 x 36	
023-02-0048	9 x 16 x 48	
023-02-0000	Divider only for nail shelf	1

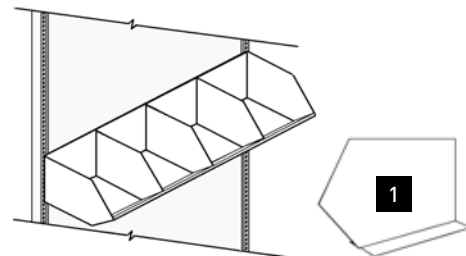

SHELF FOR CAULKING TUBE

CODE	MEASURE (IN.)	
031-09-0030	14 (12) x 30	
031-09-0036	14 (12) x 36	Can be used as magazine or bag shelf
031-09-0048	14 (12) x 48	
031-09-0001	14 in. (12 in.) D Caulking tube divider	2

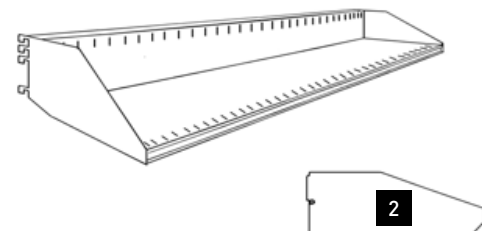

DISPLAYS

SLOPED SINK DISPLAY

SPECIAL ORDER



FAUCET DISPLAY - FOR SINK

SPECIAL ORDER

Installation on crossbar with clearance of 3, 8, 13 or 18



FAUCET DISPLAY - FOR BATH AND SHOWER

SPECIAL ORDER

Available with 3 or 5 holes



ACCESSORIES

6 in. STEEL DIVIDER FOR SHELF

CODE	MEASURE (IN.)	
028-02-1206G	12 L x 6 H	Left
028-02-1206D	12 L x 6 H	Right

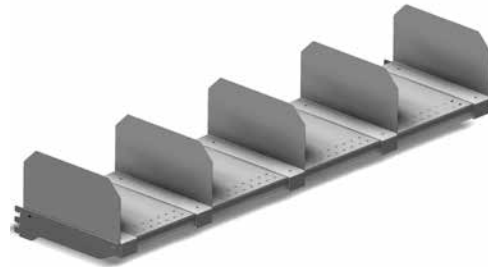

VERSA-FLEX SHELF

CODE	MEASURE (IN.)	
M20105180A500		
495302430	22 x 30	Shelf
495302436	22 x 36	Shelf
495300030	30	Facade
495300036	36	Facade

The facade makes for flexible sampling, easy to organize and perfectly aligned with identification labels



FLEX FACADE FOR WIRE MESH BASKET

CODE		
M13110283A700	47 1/2	Facade with Maxtite
M13110283A401		Fastener
700-1-14342	1/4-20 x 3/4	Bolt Gr. 2

Crossbar sold separately (see below)

The facade makes for flexible sampling, easy to organize and perfectly aligned with identification labels



TOILET SEAT DISPLAY

CODE	MEASURE (IN.)	
Bracket for toilet seat		
030-30-0012	1/2 x 1 1/2 x 12	With 14 dividers
030-30-0016	1/2 x 1 1/2 x 16	With 16 dividers
Crossbar		
030-04-0036	4 x 36	
030-04-0048	4 x 48	

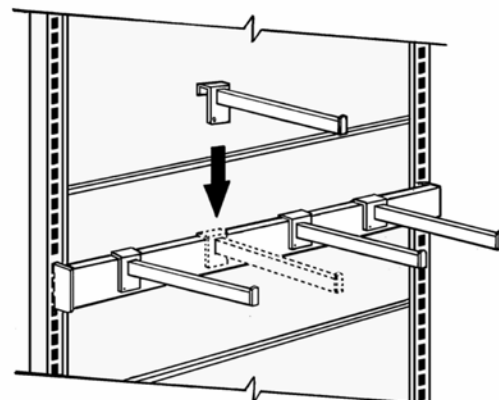

DISPLAYS

FLOORING SAMPLE DISPLAY - VERTICAL

CODE	MEASURE (IN.)	
410-30-3653J	36 L x 54 H	
410-30-3672	36 L x 72 H	With cap
M11030869K	5 x 4 x 35 3/4	Basket with brackets



SLOPED FLOORING DISPLAY

CODE	MEASURE (IN.)	
496-28-3654	28 x 38 x 54 H	Not assembled



CAR CARPET DISPLAY

CODE	MEASURE (IN.)	
M12070661-A-500	1 x 14	Reversible, curved, round tubing bracket (3 bars per crossbar on average)
030-04-0148	1 x 2 x 48	Crossbar



With reversible arms that can be positioned towards right or left



CUSTOM MADE COUNTERS AND DISPLAYS



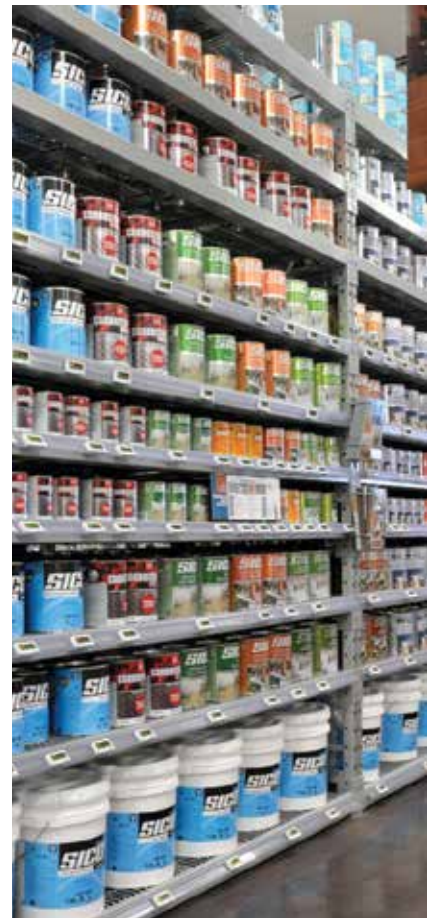



LUMBER YARD



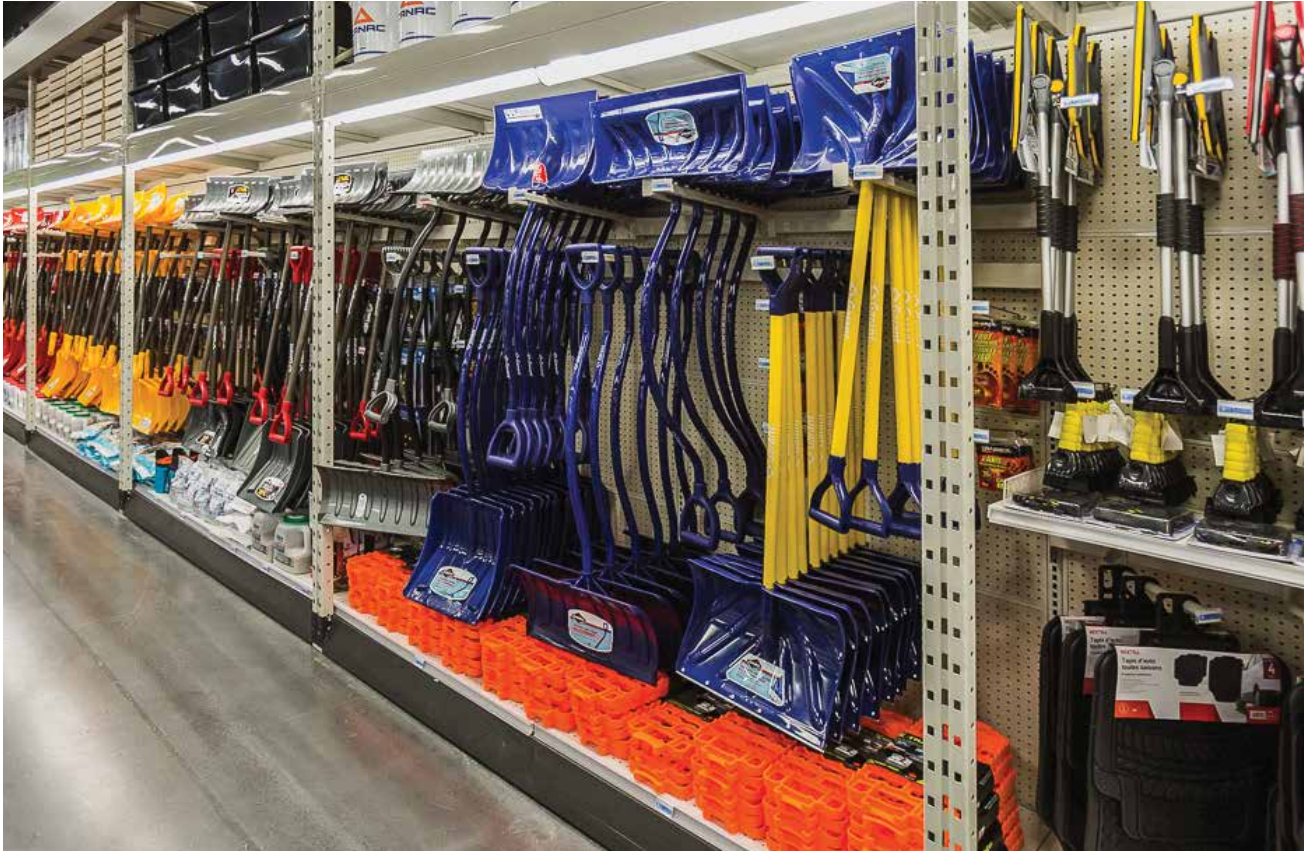



IN THIS SECTION

WAREHOUSE FRAMES

STEP BEAMS

SAFETY BARS

WAREHOUSE WIRE MESH PANELS

DIVIDERS / SPACERS

HARDWARE

PROTECTORS

COMMERCIAL RACKING

HEAVY DUTY WAREHOUSE FRAMES PROFILE

HEAVY DUTY WAREHOUSE FRAME PROFILE

2 in. x 3 1/4 in. - 14 GA

CODE	CODE	MEASURE (IN.)	DESCRIPTION
925-A-24	940-A-24	24 P	Height from 24 to 600 in., in increments of 3 in.
925-A-30	940-A-30	30 P	
925-A-36	940-A-36	36 P	
925-A-42	940-A-42	42 P	
925-A-44	940-A-44	44 P	
925-A-48	940-A-48	48 P	

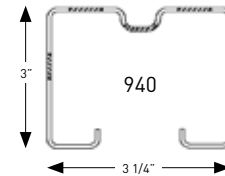
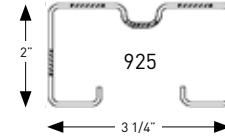
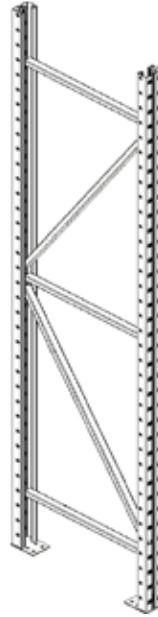

HEAVY DUTY WAREHOUSE FRAME PROFILE - WATERFALL MODEL

1.58 in. x 3 in. and 3 in. x 3 in. - 13 and 14 GA

CODE	CODE	MEASURE (IN.)	DESCRIPTION
945-A-24	947-A-24	24 P	Height from 24 to 600 in., in increments of 2 in.
945-A-30	947-A-30	30 P	
945-A-36	947-A-36	36 P	
945-A-42	947-A-42	42 P	
945-A-44	947-A-44	44 P	
945-A-48	947-A-48	48 P	

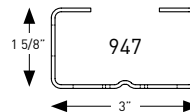
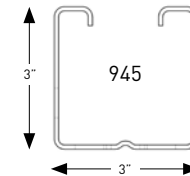
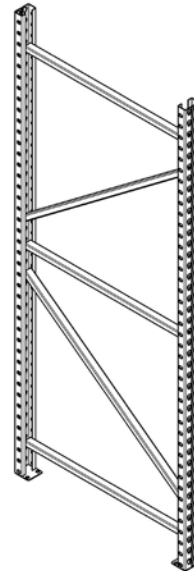

CUSTOM-MADE WAREHOUSE FRAMES

HEAVY DUTY WAREHOUSE FRAME PROFILE

3 in. x 4 in. - 13 GA

CODE	MEASURE (IN.)	DESCRIPTION
950-A-24	24 D	
950-A-30	30 D	
950-A-36	36 D	Height from 24 to 600 in., in increments of 3 in.
950-A-42	42 D	
950-A-44	44 D	
950-A-48	48 D	

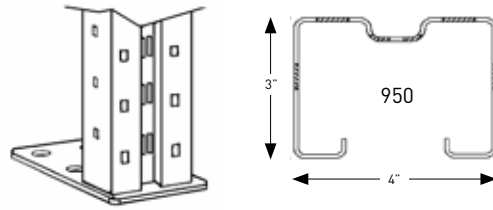

O TYPE / OPEN

CODE	MEASURE (IN.)	DESCRIPTION	SPECIAL ORDER
925-O-24	24 D		
925-O-30	30 D		
925-O-36	36 D	Can accommodate a gondola inside (wall or island)	
925-O-42	42 D		
925-O-48	48 D		

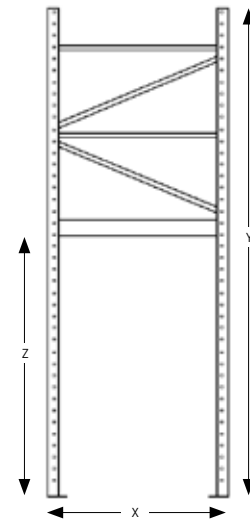

STATIONARY TOOL FOR PLATFORM FRAME

CODE	MEASURE (IN.)
925A24006A	24 D x 6 H
925A30006A	30 D x 6 H
925A36006A	36 D x 6 H
925A42006A	42 D x 6 H
925A48006A	48 D x 6 H

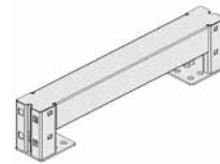

A-SHAPED FRAME FOR LARGE WIRE SPOOL

MEASURE (IN.)	SPECIAL ORDER
Uprights 3 in. x 3 1/4 in. Front upright at 84° angle	



CUSTOM-MADE WAREHOUSE FRAMES

DOUBLED TYPE

DESCRIPTION	SPECIAL ORDER
-------------	---------------

- | | |
|---|---|
| Doubled front | 1 |
| Front and back doubled to a specific height | 2 |
| Front and back fully doubled | 3 |

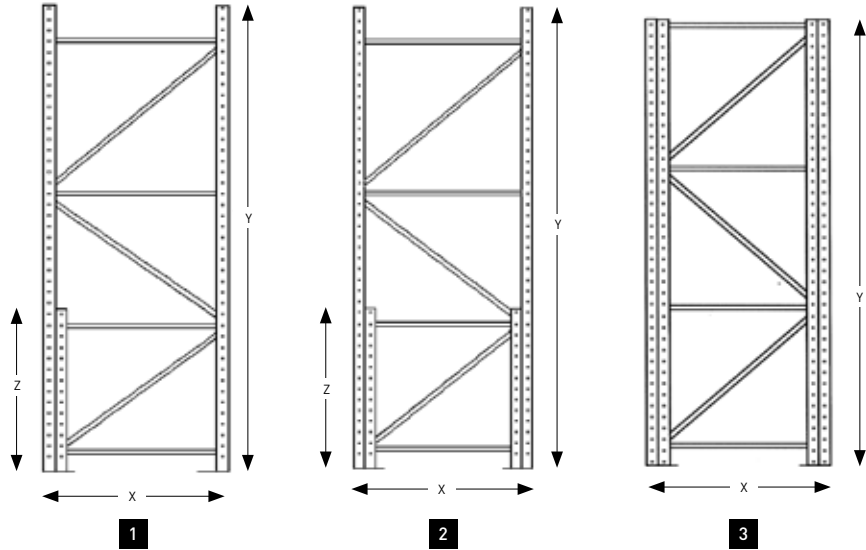

M TYPE

DESCRIPTION	SPECIAL ORDER
-------------	---------------

- | | |
|--|---|
| Rear upright higher than front upright | 4 |
|--|---|

CANT-LEG TYPE

SPECIAL ORDER

- | | |
|--|---|
| | 5 |
|--|---|

RECESSED TYPE

SPECIAL ORDER

- | | |
|--|---|
| | 6 |
|--|---|

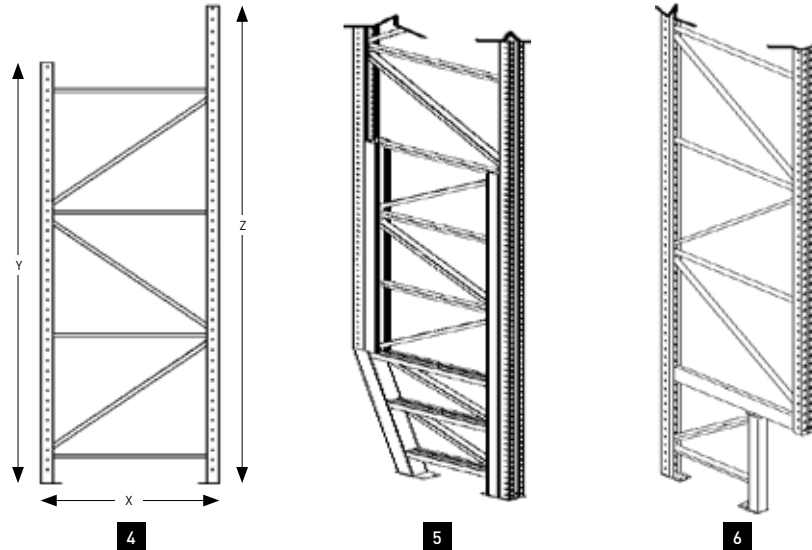

EXTENSION

DESCRIPTION	SPECIAL ORDER
-------------	---------------

- | | |
|-----------------------|--|
| 72 in. maximum height | |
| One level beams only | |

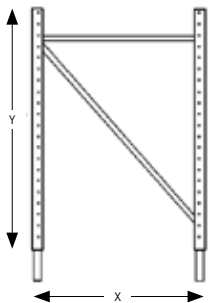

TOP-TIE TYPE

DESCRIPTION	SPECIAL ORDER
-------------	---------------

- | | |
|---|--|
| To hook a top-tie without reducing the loading zone | |
|---|--|

This is an overview of the options offered. We can adapt or create frames to meet your specifications.

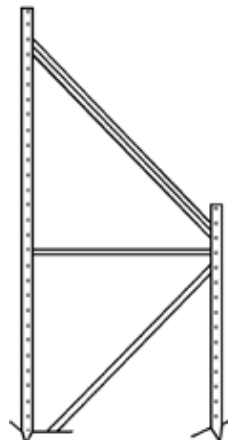

H-SHAPED FRAMES

H-SHAPED FRAME

3 in. x 3 1/4 in.

1

CODE	MEASURE (IN.)
940-H-2451144	24 D x 51 / 144 height doubled 144
940-H-2451168	24 D x 51 / 168 height doubled 168
940-H-2451192	24 D x 51 / 192 height doubled 192
940-H-3051144	30 D x 51 / 144 height doubled 144
940-H-3051168	30 D x 51 / 168 height doubled 168
940-H-3051192	30 D x 51 / 192 height doubled 192
940-H-3651144	36 D x 51 / 144 height doubled 144
940-H-3651168	36 D x 51 / 168 height doubled 168
940-H-3651192	36 D x 51 / 192 height doubled 192
940-H-4251144	42 D x 51 / 144 height doubled 144
940-H-4251168	42 D x 51 / 168 height doubled 168
940-H-4251192	42 D x 51 / 192 height doubled 192
940-H-4851168	48 D x 51 x / 168 height doubled 168
940-H-4851192	48 D x 51 / 192 height doubled 192

940-H-2460144	24 D x 60 / 144 height doubled 144
940-H-2460168	24 D x 60 / 168 height doubled 168
940-H-2460192	24 D x 60 / 192 height doubled 192
940-H-3060144	30 D x 60 / 144 height doubled 144
940-H-3060168	30 D x 60 / 168 height doubled 168
940-H-3060192	30 D x 60 / 192 height doubled 192
940-H-3660144	36 D x 60 / 144 height doubled 144
940-H-3660168	36 D x 60 / 168 height doubled 168
940-H-3660192	36 D x 60 / 192 height doubled 192
940-H-4260144	42 D x 60 / 144 height doubled 144
940-H-4260168	42 D x 60 / 168 height doubled 168
940-H-4260192	42 D x 60 / 192 height doubled 192
940-H-4860168	48 D x 60 x / 168 height doubled 168
940-H-4860192	48 D x 60 / 192 height doubled 192

Other dimensions available on request

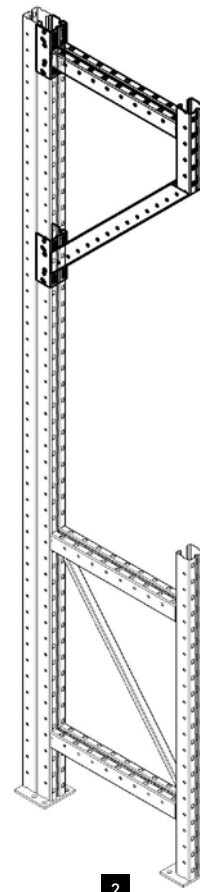
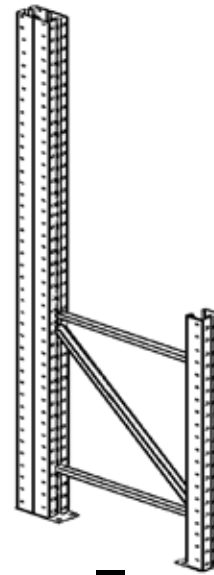

V-SHAPED DISPLAY

for H-shaped and A-shaped frames

2

CODE	MEASURE (IN.)
940VRACK24	for 24 in. depth frame
940VRACK30	for 30 in. depth frame
940VRACK36	for 36 in. depth frame
940VRACK42	for 42 in. depth frame

DISPLAYS AND FRAMES

A-SHAPED WAREHOUSE FRAME

Uprights 3 in. x 3 1/4 in. -the front upright is always 54 in. high

CODE	MEASURE (IN.)
944-AA-3054144	30 D x 144 H
944-AA-3054168	30 D x 168 H
944-AA-3054192	30 D x 192 H
944-AA-3654144	36 D x 144 H
944-AA-3654168	36 D x 168 H
944-AA-3654192	36 D x 192 H
944-AA-4254144	42 D x 144 H
944-AA-4254168	42 D x 168 H
944-AA-4254192	42 D x 192 H
944-AA-4854144	48 D x 144 H
944-AA-4854168	48 D x 168 H
944-AA-4854192	48 D x 192 H



CANTILEVER STYLE WAREHOUSE FRAME

Uprights 3 in. x 3 1/4 in. doubled 3 in. x 3 1/4 in.

CODE	MEASURE (IN.)
926-06-36144	36 D x 144 H
926-06-36168	36 D x 168 H
926-06-36192	36 D x 192 H

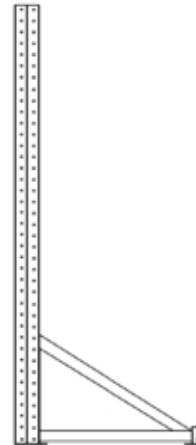

STEP BEAMS

REGULAR BEAM

CODE	HEIGHT (IN.)	LENGTHS AVAILABLE (IN.)
914ARZ	1 3/4 H	102 maximum length

R SERIES BEAM - AVAILABLE IN BASE OR REGULAR MODEL:
2 1/2, 3 1/4, 4 1/4, 6 1/4 in.

CODE	DESCRIPTION
914PAR	Regular beam with permanent safety clips
914PER	Base beam with permanent safety clips
915PAR	Regular beam without permanent safety clips
915PER	Base beam without permanent safety clips

SERIES P BEAM - AVAILABLE IN BASE OR REGULAR MODEL:
2 1/4 in.

CODE	DESCRIPTION
921APA	Regular beam with permanent safety clips
921EPA	Base beam with permanent safety clips
922APA	Regular beam without permanent safety clips
922EPA	Base beam without permanent safety clips

H SERIES BEAM - AVAILABLE IN BASE OR REGULAR MODEL:
from 2 1/2 to 7 1/2 in., in increments of 1/2 in.

CODE	DESCRIPTION
966PAH	Regular beam with permanent safety clips
966PEH	Base beam with permanent safety clips
967PAH	Regular beam without permanent safety clips
967PEH	Base beam without permanent safety clips



15/16"



1 3/4"

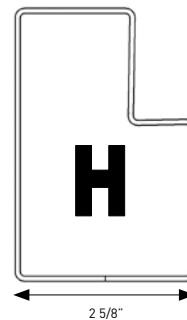

2 5/8"

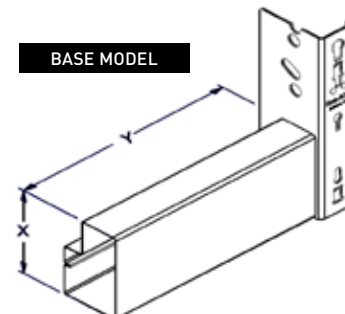
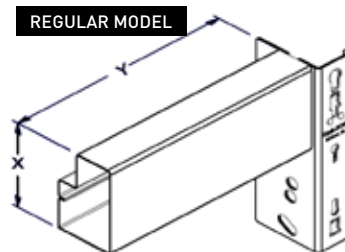

WATERFALL BEAMS

R SERIES BEAM - WATERFALL MODEL

AVAILABLE IN BASE OR REGULAR MODEL: 2 1/2, 3 1/4, 4 1/4, 6 1/4 in.

CODE	DESCRIPTION
------	-------------

939PAR	Regular beam with permanent safety clips
--------	---

939PER	Base beam with permanent safety clips
--------	--



SERIES P BEAM - WATERFALL MODEL

AVAILABLE IN BASE OR REGULAR MODEL: 2 1/4 in.

CODE	DESCRIPTION
------	-------------

936APA	Regular beam with permanent safety clips
--------	---

936EPA	Base beam with permanent safety clips
--------	--

937APA	Regular beam without permanent safety clips
--------	--

937EPA	Base beam without permanent safety clips
--------	---



H SERIES BEAM - WATERFALL MODEL

AVAILABLE IN BASE OR REGULAR MODEL:
from 2 1/2 to 7 1/2 in., in increments of 1/2 in.

CODE	DESCRIPTION
------	-------------

968PAH	Regular beam with permanent safety clips
--------	---

968PEH	Base beam with permanent safety clips
--------	--

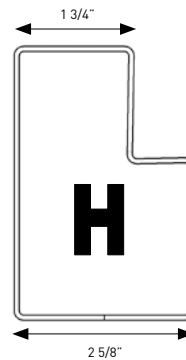

STEP BEAMS

R-SERIES SLOPED BASE STEP BEAM - 3 in. high WITH PERMANENT SAFTEY CLIPS

CODE	MEASURE (IN.)
914-E-303512A	3 H x 35 1/2 L
914-E-304412A	3 H x 44 1/2 L
914-E-304512A	3 H x 45 1/2 L
914-E-3048A	3 H x 48 L
914-E-3051A	3 H x 51 L
914-E-3054A	3 H x 54 L
914-E-305612A	3 H x 56 1/2 L
914-E-3060A	3 H x 60 L
914-E-3060A	3 H x 66 L
914-E-306812A	3 H x 68 1/2 L
914-E-3072A	3 H x 72 L
914-E-307412A	3 H x 74 1/2 L
914-E-3078A	3 H x 78 L
914-E-308012A	3 H x 80 1/2 L
914-E-3084A	3 H x 84 L
914-E-3090A	3 H x 90 L
914-E-309212A	3 H x 92 1/2 L
914-E-3096A	3 H x 96 L
914-E-309812A	3 H x 98 1/2 L
914-E-3099A	3 H x 99 L
914-E-309912A	3 H x 99 1/2 L
914-E-3102A	3 H x 102 L

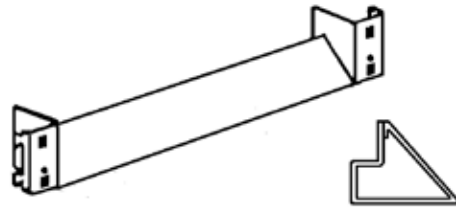

SLOPED KICKPLATE - 6 in. high WITH PERMANENT SAFTEY CLIPS

CODE	MEASURE (IN.)
914-G-004412	6 H x 44 1/2 L
914-G-0048	6 H x 48 L
914-G-009212	6 H x 92 1/2 L
914-G-0096	6 H x 96 L
914-G-0102	6 H x 102 L
914-G-0140½	6 H x 140 1/2 L
914-G-0144	6 H x 144 L

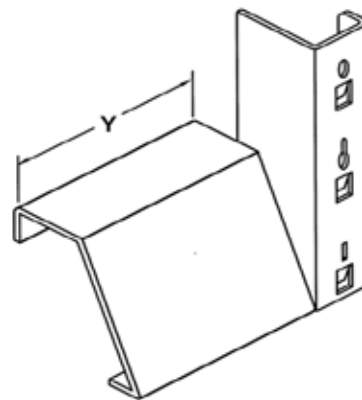

BEAMS AND SAFETY CLIPS

BOX BEAM

CODE WITHOUT SAFETY CLIP	CODE WITH SAFETY CLIP	THICKNESS (IN.)	DIMENSIONS
913 AD	912 AD	1 1/2 H	Heights: 2 to 8 in. Lengths: 48 to 180 in.
913 AK	912 AK	1 3/4 H	
913 AP	912 AP	2 H	

Available with or without permanent safety clips
Availability varies according to demand
Other dimensions available on request



REGULAR SAFETY CLIP

CODE	DESCRIPTION
401-A0-0000A	To be used with brackets made BEFORE 2010 (1/8 in. thickness)



SPRING TYPE SAFETY CLIP

CODE	DESCRIPTION
401-A0-0001	To be used with brackets made BEFORE 2010



SAFETY CLIP LOCK FOR MODEL F2010

CODE	DESCRIPTION
401-A0-0003	To be used with brackets made AFTER 2010

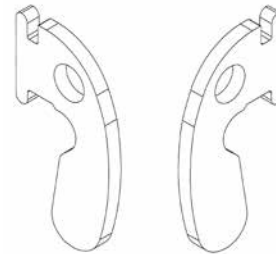

PLASTIC CLIP

CODE	DESCRIPTION
401-A0-0011CP	To facilitate the removal of a beam with permanent safety clips

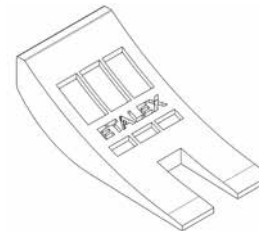

SAFETY BARS

RIVET TYPE SAFETY CLIP

CODE	DESCRIPTION
401-A0-0011	To be used with beams made AFTER 2010

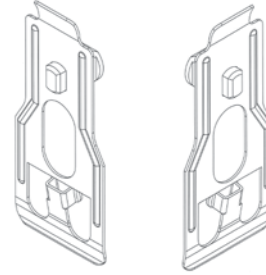

REGULAR SAFETY CLIP

CODE	DESCRIPTION
401-A-00005	To facilitate the removal of a beam with a permanent security lock

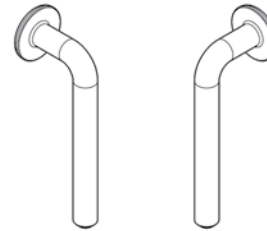

HEAVY DUTY SAFETY BAR FOR STEP BEAM H SERIES

CODE	MEASURE (IN.)
401-B0-0221	2 H x 24 3/8 L
401-B0-0227	2 H x 30 3/8 L
401-B0-0233	2 H x 36 3/8 L
401-B0-0239	2 H x 42 3/8 L
401-B0-0245	2 H x 45 3/8 L

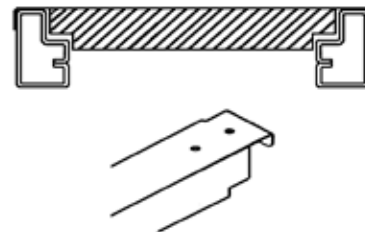

REGULAR CLIP-ON TYPE SAFETY BAR FOR STEP BEAM

CODE	MEASURE (IN.)
R SERIES	
401-RK-0221	2 H x 20 15/16 L (24)
401-RK-0227	2 H x 26 15/16 L (30)
401-RK-0233	2 H x 32 15/16 L (36)
401-RK-0239	2 H x 38 15/16 L (42)
401-RK-0245	2 H x 44 15/16 L (48)

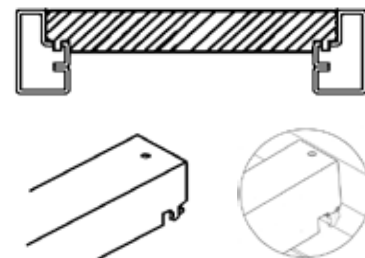

H SERIES	
401-HK-0220	2 H x 20 1/16 L (24)
401-HK-0226	2 H x 26 1/16 L (30)
401-HK-0232	2 H x 32 1/16 L (36)
401-HK-0238	2 H x 38 1/16 L (42)
401-HK-0240	2 H x 40 1/16 L (44)
401-HK-0244	2 H x 44 1/16 L (48)

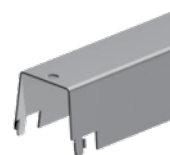

SAFETY BARS

RECESSED SAFETY BAR FOR STEP BEAM

7/8 in. THICKNESS

CODE	MEASURE (IN.)	DESCRIPTION
R SERIES		
401-RL-02201116	2 H x 20 11/16 L (24)	
401-RL-02261116	2 H x 26 11/16 L (30)	
401-RL-02321116	2 H x 32 11/16 L (36)	With anchoring pins
401-RL-02381116	2 H x 38 11/16 L (42)	
401-RL-02441116	2 H x 44 11/16 L (48)	

H SERIES

401-HL-0220	2 H x 20 1/16 L (24)	
401-HL-0226	2 H x 26 1/16 L (30)	
401-HL-0232	2 H x 32 1/16 L (36)	With anchoring pins
401-HL-0238	2 H x 38 1/16 L (42)	
401-HL-0244	2 H x 40 1/16 L (44)	



UNIVERSAL SAFETY BAR FOR BOX BEAM

1 1/2 to 2 in. THICKNESS

CODE	MEASURE (IN.)	
404-J0-0221	2 H x 19 9/16 L (24)	
404-J0-0227	2 H x 25 9/16 L (30)	
404-J0-0233	2 H x 31 9/16 L (36)	
404-J0-0239	2 H x 37 9/16 L (42)	
404-J0-0244	2 H x 39 9/16 L (44)	
404-J0-0245	2 H x 43 9/16 L (48)	

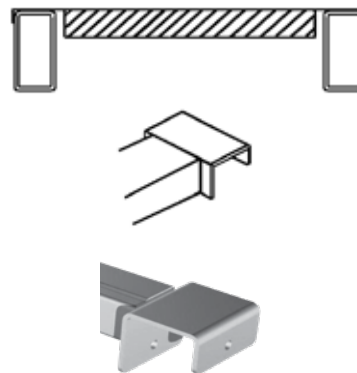

HEAVY DUTY SAFETY BAR FOR BOX BEAM

1 1/2 to 2 in. THICKNESS

CODE	MEASURE (IN.)	
404-J0-0221INV	2 H x 19 9/16 L (24)	With cup welded backward
404-J0-0227INV	2 H x 25 9/16 L (30)	With cup welded backward
404-J0-0233INV	2 H x 31 9/16 L (36)	With cup welded backward
404-J0-0239INV	2 H x 37 9/16 L (42)	With cup welded backward
404-J0-0244INV	2 H x 39 9/16 L (44)	With cup welded backward
404-J0-0245INV	2 H x 43 9/16 L (48)	With cup welded backward

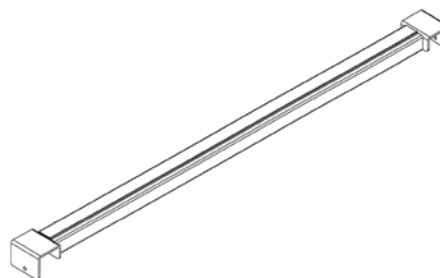

SECURITY BARS

GALVANIZED SHELF

CODE	MEASURE (IN.)	
R SERIES		
402-D0-0333	1 5/8 H x 33 3/16 L (36)	3 1/2 D
402-D0-0433	1 5/8 H x 33 3/16 L (36)	4 1/2 D
402-D0-0621	1 7/16 H x 21 3/16 L (24)	5 15/16 D
402-D0-0627	1 7/16 H x 21 3/16 L (30)	5 15/16 D
402-D0-0633	1 7/16 H x 33 3/16 L (36)	5 15/16 D
402-D0-0639	1 7/16 H x 39 3/16 L (42)	5 15/16 D
402-D0-0645	1 7/16 H x 45 3/16 L (48)	5 15/16 D
H SERIES		
402-DH-0620	1 7/16 H x 20 1/8 L (24)	5 15/16 D
402-DH-0626	1 7/16 H x 26 1/8 L (30)	5 15/16 D
402-DH-0632	1 7/16 H x 32 1/8 L (36)	5 15/16 D
402-DH-0638	1 7/16 H x 38 1/8 L (42)	5 15/16 D
402-DH-0644	1 7/16 H x 44 1/8 L (48)	5 15/16 D

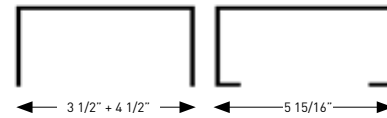
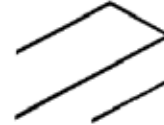

UNIVERSAL SECURITY BAR

CODE	DESCRIPTION
404J00036	Galvanized
404J00042	Galvanized
404J00048	Galvanized

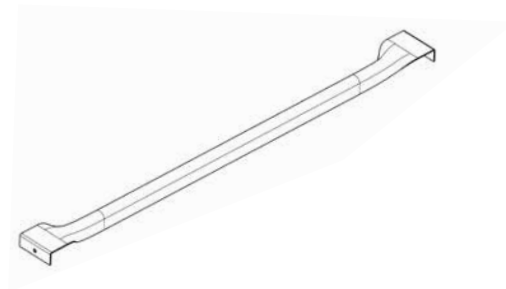

HEAVY-DUTY SAFETY BAR FOR BOX BEAM

DESCRIPTION	SPECIAL ORDER
Built with a box beam	

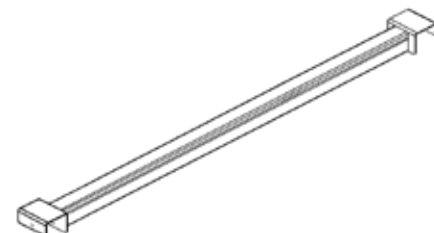

PLYWOOD SUPPORT

DESCRIPTION	SPECIAL ORDER
For 2 in. step beam - P Series	

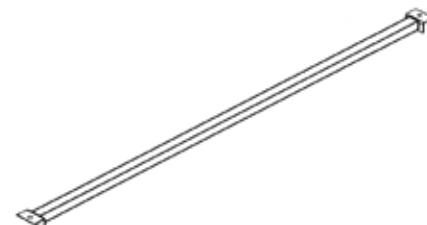

WAREHOUSE GRIDS (DECKING)

R SERIES WAREHOUSE GRID FOR STEP BEAM

IN-STEP TYPE - 1 5/8 in. height

CODE	MEASURE (IN.)	DESCRIPTION
403R21D34AD	21 D x 34 1/4 L (24)	Cap. 2000 lb
403R21D46AD	21 D x 46 L (24)	Cap. 2000 lb
403R21D49ED	21 D x 49 L (24)	Cap. 2000 lb
403R21D59AD	21 D x 59 L (24)	Cap. 2000 lb
403R27D34AD	27 D x 34 1/4 L (30)	Cap. 2000 lb
403R27D46AD	27 D x 46 L (30)	Cap. 2000 lb
403R27D49ED	27 D x 49 L (30)	Cap. 2000 lb
403R27D59AD	27 D x 59 L (30)	Cap. 2000 lb
403R33D34AC	33 D x 34 1/4 L (36)	Cap. 2000 lb
403R33D46AD	33 D x 46 L (36)	Cap. 2000 lb
403R33D49ED	33 D x 49 L (36)	Cap. 2000 lb
403R33D59AD	33 D x 59 L (36)	Cap. 2000 lb
403R39D34AC	39 D x 34 1/4 L (42)	Cap. 1500 lb
403R39D46AC	39 D x 46 L (42)	Cap. 1500 lb
403R39D49ED	39 D x 49 L (42)	Cap. 1500 lb
403R39D59AD	39 D x 59 L (42)	Cap. 1500 lb
403R45D34AC	45 D x 34 1/4 L (48)	Cap. 1500 lb
403R45D46AC	45 D x 46 L (48)	Cap. 1500 lb
403R45D49EC	45 D x 49 L (48)	Cap. 1500 lb
403R45D59AC	45 D x 59 L (48)	Cap. 1500 lb

2 1/2 x 4 1/2 in. spacing



HR SERIES WAREHOUSE GRID FOR STEP BEAM

IN-STEP TYPE - 1 5/8 in. height

CODE	MEASURE (IN.)	DESCRIPTION
403H20D35AC	20 1/8 D x 35 L (24)	CR2X4 2R Cap. 1500 lb
403H20D47AD	20 1/8 D x 47 L (24)	CR2X4 3R Cap. 2000 lb
403H20D49ED	20 1/8 D x 49 1/4 L (24)	CR3X4 2R Cap. 2000 lb
403H26D35AC	26 1/8 D x 35 L (30)	CR2X4 2R Cap. 1500 lb
403H26D47AD	26 1/8 D x 47 L (30)	CR2X4 3R Cap. 2000 lb
403H26D49ED	26 1/8 D x 49 1/4 L (30)	CR2X4 3R Cap. 2000 lb
403H32D35AC	32 1/8 D x 35 L (36)	CR2X4 2R Cap. 1500 lb
403H32D45ED	32 1/8 D x 45 1/4 L (36)	CR2X4 3R Cap. 2000 lb
403H32D47AD	32 1/8 D x 47 L (36)	CR2X4 3R Cap. 2000 lb
403H32D49eD	32 1/8 D x 49 1/4 L (36)	CR2X4 3R Cap. 2000 lb
403H38D35AC	38 1/8 D x 35 L (42)	CR2X4 2R Cap. 1500 lb
403H38D45ED	38 1/8 D x 45 1/4 L (42)	CR2X4 3R Cap. 1500 lb
403H38D47AC	38 1/8 D x 47 L (42)	CR2X4 3R Cap. 1500 lb
403H38D49ed	38 1/8 D x 49 1/4 L (42)	CR2X4 4R Cap. 2000 lb
403H44D45EC	44 1/8 D x 45 1/4 L (48)	CR2X4 3R Cap. 1500 lb
403H44D47AC	44 1/8 D x 47 L (48)	CR2X4 4R Cap. 2000 lb
403H44D49ed	44 1/8 D x 49 1/4 L (48)	CR2X4 4R Cap. 2000 lb

2 1/2 x 4 1/2 in. spacing



WAREHOUSE GRIDS (DECKING)

PERFORATED PANEL FOR WIRE MESH DECKING

1 5/8 in. height, with front banded to cover a wire mesh decking in-step (**SERIES R** and **H**), galvanized finish

CODE	MEASURE (IN.)
403U21D35EA410	21 3/16 D x 35 1/4 L (24)
403U21D46EA410	21 3/16 D x 46 1/4 L (24)
403U21D49JA410	21 3/16 D x 49 1/4 L (24)
403U21D59EA410	21 3/16 D x 59 1/4 L (24)
403U27D35EA410	27 3/16 D x 35 1/4 L (30)
403U27D46EA410	27 3/16 D x 46 1/4 L (30)
403U27D49JA410	27 3/16 D x 49 1/4 L (30)
403U27D59EA410	27 3/16 D x 59 1/4 L (30)
403U33D35EA410	33 3/16 D x 35 1/4 L (36)
403U33D46EA410	33 3/16 D x 46 1/4 L (36)
403U33D49JA410	33 3/16 D x 49 1/4 L (36)
403U33D59EA410	33 3/16 D x 59 1/4 L (36)
403U39D35EA410	39 3/16 D x 35 1/4 L (42)
403U39D46EA410	39 3/16 D x 46 1/4 L (42)
403U39D49JA410	39 3/16 D x 49 1/4 L (42)
403U39D59EA410	39 3/16 D x 59 1/4 L (42)
403U45D35EA410	45 3/16 D x 35 1/4 L (48)
403U45D46EA410	45 3/16 D x 46 1/4 L (48)
403U45D49JA410	45 3/16 D x 49 1/4 L (48)
403U45D59EA410	45 3/16 D x 59 1/4 L (48)

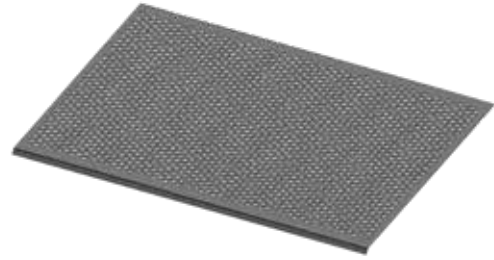

DIVIDER/SPACER

R SERIES WIRE GRID DIVIDER - PAINTED SILVER

CODE	MEASURE (IN.)
F07R2461900	6 x 19
F07R2862300	6 x 23
F07R3062500	6 x 25
F07R3663100	6 x 31
F07R4263700	6 x 37



END SPACER WITHOUT HARDWARE

CODE	MEASURE (IN.)
92430-04	4
92430-06	6
92430-08	8
92430-09	9
92430-10	10
92430-12	12
92430-14	14
92430-16	16
92430-18	18
92430-24	24

Other dimensions available on request

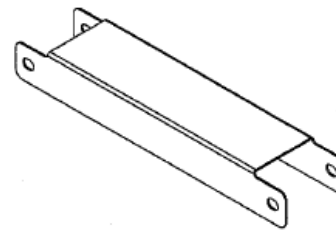

END FEATURE SPACER

CODE	MEASURE (IN.)	SPECIAL ORDER
424-03-0120	20	



HARDWARE

CONCRETE ANCHOR

CODE	MEASURE (IN.)
700-5-38314	3/8 x 3 3/4 L
700-5-12334	1/2 x 4 1/2 L
700-5-12512	1/2 x 5 1/2 L
700-5-58412	5/8 x 4 1/2 L
700-5-5810	5/8 x 10 L
700-5-34435	3/4 x 4 3/4 L



BOLT

CODE	MEASURE (IN.)	DESCRIPTION
700-1-71615	7/16 -14 x 1	GR 5 zinc
700-1-71645	7/16 -14 x 4	GR 5 zinc
700-1-7164125	7/16 -14 x 4 1/2	GR 5 zinc
700-1-71655	7/16 -14 x 5	GR 5 zinc



FLANGE NUT

CODE	MEASURE (IN.)	DESCRIPTION
700-2-7162	7/16 -14	GR 2 zinc



CHICAGO BOLT

CODE	MEASURE (IN.)	DESCRIPTION
700-SBMA-400	7/16 x 3 (male)	GR 5 zinc
700-SBFA-401	7/16 x 1 7/8 (female)	GR 5 zinc



TEK SCREW (SELF-TAPING)

CODE	MEASURE (IN.)	DESCRIPTION
700-6-0101	#12-24 x 1 1/4	#5 structural head
700-6-14101	#14 x 1	GR 5 zinc



SELF-TAPING SCREW

CODE	MEASURE (IN.)	DESCRIPTION
700-1-138342HDTYPEF	3/8 - 16 x 3/4	Hex head zinc



SHIMS

LEVELING SHIM

CODE	MEASURE (IN.)	THICKNESS (IN.)
420-01-0001	3 1/2 x 4 1/2	1/32
420-01-0002	3 1/2 x 4 1/2	1/8
420-01-0003	3 1/2 x 4 1/2	1/16
420-01-0004	3 1/2 x 4 1/2	3/16
420-01-0201	3 1/2 x 6	1/32
420-01-0202	3 1/2 x 6	1/8
420-01-0203	3 1/2 x 6	1/16
420-01-0204	3 1/2 x 6	3/16
420-01-0302	3 1/2 x 8	1/32
420-01-0303	3 1/2 x 8	1/16
420-01-0304	3 1/2 x 8	12 ga

Other sizes available upon request

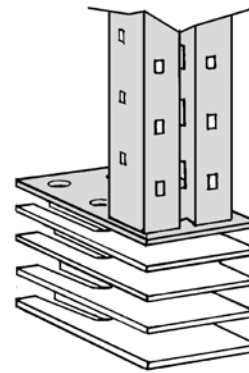

SHIM FOR FRAME WITH WEDGE SHAPED FOOTPLATE

CODE	MEASURE (IN.)	THICKNESS
For 2 x 3 1/4 in. or 3 x 3 1/4 in. frame		
420-01-13128PS20G	3 1/2 x 8	20 ga
420-01-13128PS16G	3 1/2 x 8	16 ga
420-01-13128PS12G	3 1/2 x 8	12 ga
420-01-04J08AP20G	4 1/2 x 8	20 ga
420-01-04J08AP16G	4 1/2 x 8	16 ga
420-01-04J08AP12G	4 1/2 x 8	12 ga

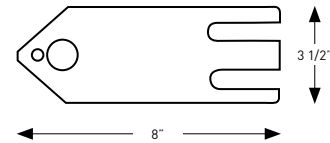

For 2 x 3 1/4 in. doubled 2 x 3 1/4 in. frame		
420-01-13129PS20G	3 1/2 x 9	20 ga
420-01-13129PS16G	3 1/2 x 9	16 ga
420-01-13129PS12G	3 1/2 x 9	12 ga
420-01-04J09AP20G	4 1/2 x 9	20 ga
420-01-04J09AP16G	4 1/2 x 9	16 ga
420-01-04J09AP12G	4 1/2 x 9	12 ga

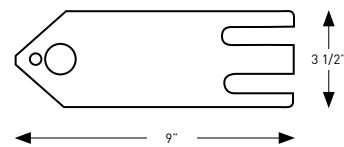

For 3 x 3 1/4 in. doubled 2 x 3 1/4 in. or doubled 3 x 3 1/4 in. frame		
420-01-131211PS20G	3 1/2 x 11	20 ga
420-01-131211PS16G	3 1/2 x 11	16 ga
420-01-131211PS12G	3 1/2 x 11	12 ga
420-01-04J11AP20G	4 1/2 x 11	20 ga
420-01-04J11AP16G	4 1/2 x 11	16 ga
420-01-04J11AP12G	4 1/2 x 11	12 ga

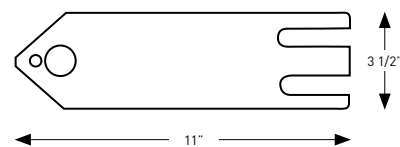

SECURITY PROTECTORS

SECURITY CABLE ATTACHMENT BRACKETS

CODE	DESCRIPTION	
M15125988A500	LEFT side	1
M15125988A501	RIGHT side	2

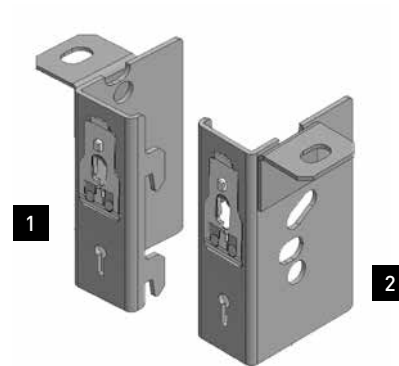

WIRE RETAINER TUBING WITH BRACKET

to be used with H-shaped frame

CODE	MEASURE (IN.)
410-13-0021	1 1/2 x 1 1/2 x 21

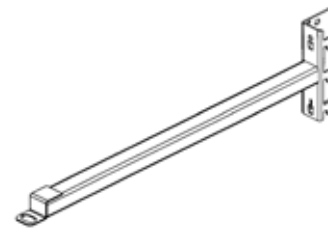

UPRIGHT PROTECTOR FOR COMMERCIAL USE

2 or 4 concrete anchors 1/2 x 3 3/4 in. (not included)

CODE	MEASURE (IN.)	DESCRIPTION
Anchored -V-shaped with base plate		
409-03-0312	3 x 3 x 12	Corner
409-03-0318	3 x 3 x 18	Corner
409-03-0324	3 x 3 x 24	Corner
409-03-0312A	3 x 3 x 12	Facade
409-03-0318A	3 x 3 x 18	Facade
409-03-0324A	3 x 3 x 24	Facade

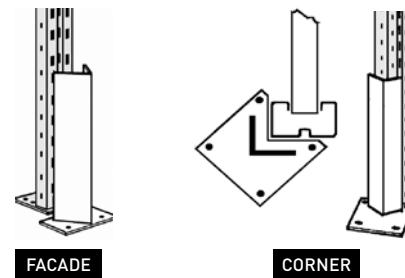

Anchored - half-moon

409-04-0036	36 H
409-04-0024	24 H
409-04-0018	18 H
409-04-0012	12 H

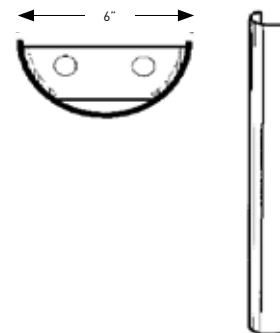

UPRIGHT PROTECTORS

UPRIGHT CLIP-ON PROTECTOR - COMMERCIAL USE

CODE	MEASURE (IN.)	DESCRIPTION	
409-04-2506	6 H	V-angle welded to two brackets	1
409-04-2515	15 H	V-angle welded to three brackets	2
409-04-2524	24 H	V-angle welded to four brackets	3

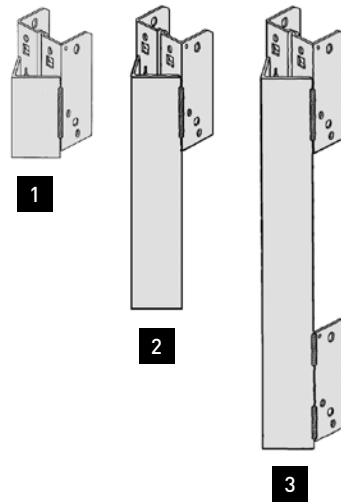

V-SHAPED UPRIGHT PROTECTOR - INDUSTRIAL USE

CODE	DESCRIPTION	
Model 1	No beams present on the full height of protector	1
Model 2	With a notch to go over beam	2

Wrap around V-shaped, with a sanitary cap, to be bolted to the upright, also in addition of a special plate, can be anchored to the floor.

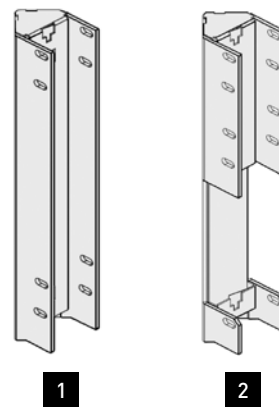

UPRIGHT PROTECTORS

END OF AISLE GUARDRAIL

AVAILABLE WITH OR WITHOUT BEVELED ENDS

MEASURE (IN.)	DESCRIPTION	SPECIAL ORDER
4 x 6 x 0.3125	Requires 5/8 x 4 3/4 in. anchors	

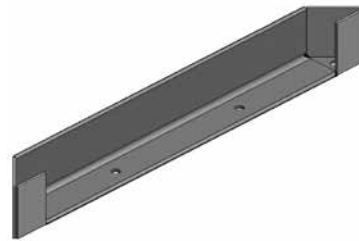

PALETTE UPRIGHT STOPPER

DESCRIPTION	SPECIAL ORDER
-------------	---------------

The upright will prevent the pallet from being positioned too far back by the fork-lift driver and avoid that the pallet falls through.

The height of the upright and the spacing from the beams will be according to your specifications.

The type of beam onto which the brackets will fasten needs to be specified to your Sales Representative.



MISCELLANEOUS

OSP TYPE FLOORING

CODE	MEASURE (IN.)	SPECIAL ORDER
OSP-9-144	9 L x 144	

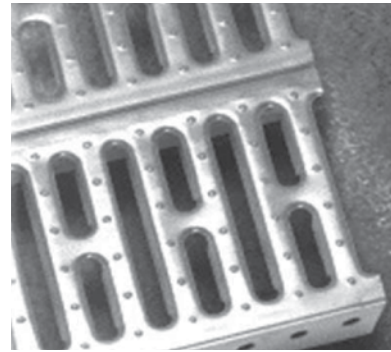

METAL PANEL FOR PLATFORM

SPECIAL ORDER

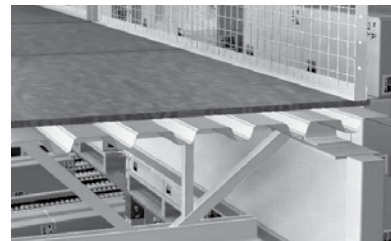
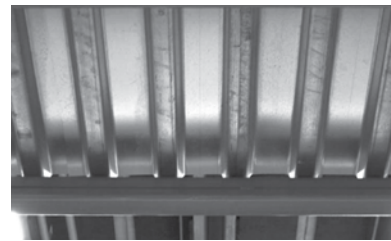

MEZZDECK TYPE FLOOR PANEL FOR PLATFORM

SPECIAL ORDER

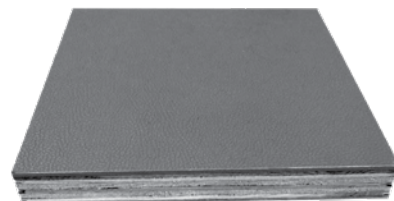

STOPPERS AND DOORS

PALLET BEAM STOPPER

DESCRIPTION

SPECIAL ORDER

Various models and dimensions



TIP-UP GUARDRAIL

SPECIAL ORDER



SLIDING GUARDRAIL

DESCRIPTION

SPECIAL ORDER

WARNING: As per regulations, the employee working near the opening when the gate is open must wear a safety harness and be tethered to a safety line.



WIRE MESH DOORS

PROTECTIVE WIRE MESH PANEL

DESCRIPTION

SPECIAL ORDER

To prevent items from falling down



SLIDING WIRE MESH DOORS

DESCRIPTION

SPECIAL ORDER

For a 90 H x 102 W in. bay

Requires a 6 in. step beam at the top and a 4 in. step beam at the bottom
Other dimensions available on request

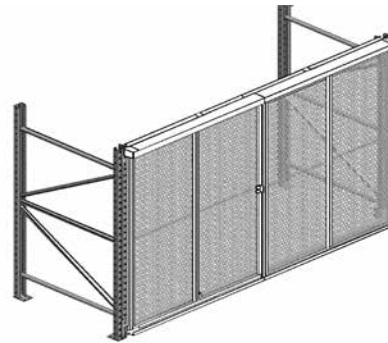

SWIVELLING WIRE MESH DOOR

DESCRIPTION

SPECIAL ORDER

Attached to the uprights with brackets with hinge pin
Available with one or two doors
Model shown: 48 in. single left door



WAREHOUSE BRACKETS

BRACKET WITH HINGE

CODE	DESCRIPTION
404-00-0001	Left
404-00-0002	Right



SANITARY CAP FOR UPRIGHT

CODE	MEASURE (IN.)
409-02-0000	For 2 x 3 1/4 in. upright
409-02-0000	For 3 x 3 1/4 in. upright

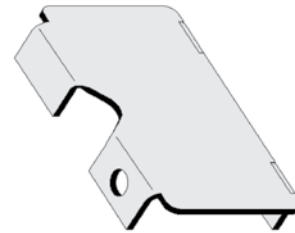

END CAP PROTECTOR IN MOLDED PLASTIC

CODE	DESCRIPTION
EMEndJAUNE2314	Yellow finish for 2 x 3 1/4 in. upright
EMEndJAUNE3314	Yellow finish for 3 x 3 1/4 in. upright
EMEndGRIS1583	Grey finish for 1 5/8 x 3 in. waterfall upright



MISCELLANEOUS

RECESSED STEP BEAM

CODE	DESCRIPTION AND MEASURE (IN.)
911-013-096A800	96 in. R Series recessed step beam
Including	
911-01-3096	Step beam 3 x 94 3/8 in. with 5 1/8 x 6 in. steel plate (1 x)
910-02-G0820A	Left ajustable bracket 5 x 20 in. (1 x)
910-02-D0820A	Right ajustable bracket 5 x 20 in. (1 x)
910-02-0800	Adaptor bracket extension (male) (2 x)
700-1-71615	7/16 x 1 in. bolt - gr 5 zinc (12 x)
700-2-7162	7/16 in. flange nut - gr 2 zinc (12 x)
700-1-1412	1/4-20 x 1 in. bolt - gr 2 zinc (2 x)
700-2-1421	1/4-20 nut - gr 2 zinc (2 x)
911-013-102A800	102 in. R Series recessed step beam
Including	
911-01-3102	Step beam 3 x 100 3/8 in. with 5 1/8 x 6 in. steel plate (1 x)
910-02-G0820A	Left ajustable bracket 5 x 20 in. (1 x)
910-02-D0820A	Right ajustable bracket 5 x 20 in. (1 x)
910-02-0800	Adaptor bracket extension (male) (2 x)
700-1-71615	7/16 x 1 in. bolt - gr 5 zinc (12 x)
700-2-7162	7/16 in. flange nut - gr 2 zinc (12 x)
700-1-1412	1/4-20 x 1 in. bolt - gr 2 zinc (2 x)
700-2-1421	1/4-20 nut - gr 2 zinc (2 x)
Other dimensions available on request	

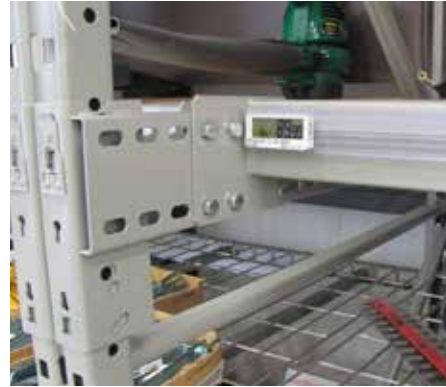

PEGBOARD PANEL BRACKET KIT

CODE	DESCRIPTION AND MEASURE (IN.)
495-3606-A800	Brackets to attach a pegboard panel to warehouse frames
Including	
495-36-06A500	16 3/8 in. U-shaped bracket right side perforated with 9 in. connector and safety clip (2 x)
495-36-06A501	16 3/8 in. U-shaped bracket left side perforated with 9 in. connector and safety clip (2 x)
M13070871A400	Frame attachment plate with two hooks, 2 15/16 in. x 3 3/4 in. (4 x)
Frame and pegboard NOT INCLUDED	



ACCESSORIES

4 in. HIGH MOLDING DIVIDER - PAINTED FINISH

CODE	MEASURE (IN.)
R SERIES	
411-03-0020	20 (24)
411-03-0026	26 (30)
411-03-0030	30 (36)
411-03-0036	36 (42)
411-03-0042	42 (48)
H SERIES	
411-H3-0020	20 (24)
411-H3-0026	26 (30)
411-H3-0030	30 (36)
411-H3-0036	36 (42)
411-H3-0042	42 (48)

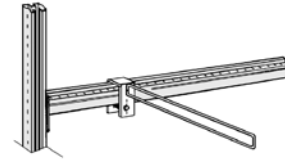

TRIANGULAR SHAPED DIVIDER

CODE	MEASURE (IN.)
R SERIES	
411-H1-2030	20 H x 30 D
H SERIES	
411-H1-2030	20 H x 30 D

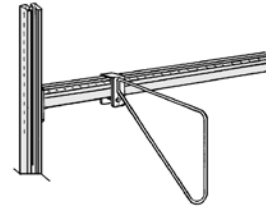

C-SHAPED DIVIDER

CODE	MEASURE (IN.)
R SERIES	
411-00-3024	24 H x 30 D
411-00-3048	48 H x 30 D
H SERIES	
411-H0-3024	24 H x 30 D
411-H0-3048	48 H x 30 D

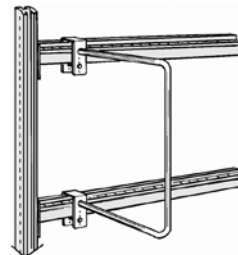

M-SHAPED DIVIDER

CODE	MEASURE (IN.)
R SERIES	
411-00-3072	72 H x 30 D

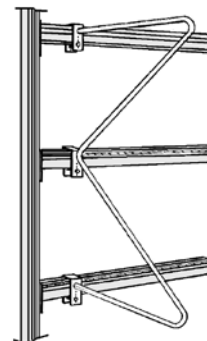

ACCESSORIES

25° ANGLE DOOR DIVIDER

CODE	MEASURE (IN.)
------	---------------

R SERIES

411-02-0030	30
411-02-0040	40

H SERIES

411-H2-0030	30
411-H2-0040	40

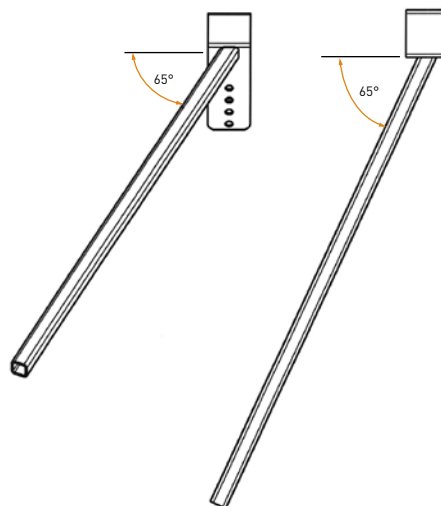

UNIVERSAL ADJUSTABLE DIVIDER

MEASURE (IN.)	MEASURE (IN.)
---------------	---------------

12 to 24	Adjustable
16 to 30	Adjustable

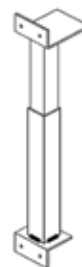

LAMINATE DIVIDER

CODE	MEASURE (IN.)	DESCRIPTION
405-02-0000	102 H x 42 D	With extendable adaptors

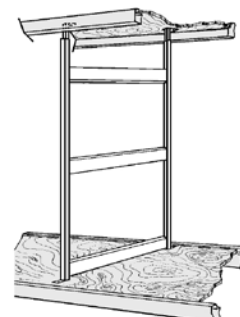

3-LEVEL LAMINATE BEAM

CODE	MEASURE (IN.)
------	---------------

414-S3-102	102 L
------------	-------



WAREHOUSE RACKING

FLOOR RACK FOR LONG MATERIAL

CODE	MEASURE (IN.)
410-02-455701A700	45 H ext. (39 3/4 int.) x 57 L ext (51 int.)

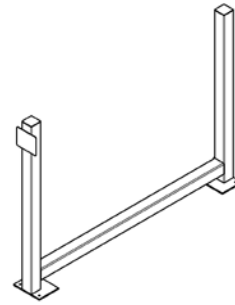

BASEMENT WINDOW WELL DISPLAY

SPECIAL ORDER

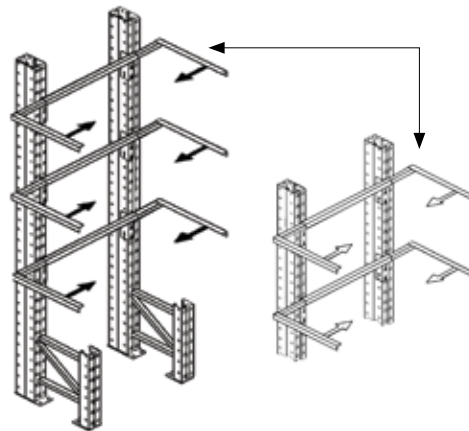

SPA DISPLAY - 42 in.

CODE	DESCRIPTION
PRE-SPA-01	Includes right and left arms and two rods

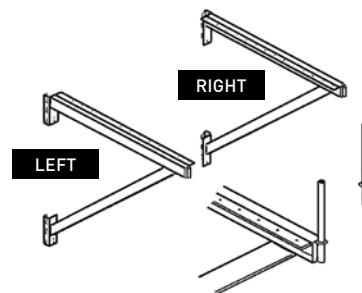

WAREHOUSE RACKING

FORK ENTRY BAR

CODE	MEASURE (IN.)
401-H0-0324	3 x 24
401-H0-0330	3 x 30
401-H0-0336	3 x 36
401-H0-0342	3 x 42
401-H0-0348	3 x 48
401-H0-0354	3 x 54
401-H0-0360	3 x 60



SPECIAL BEAMS FOR PLYWOOD BUNDLES - R SERIES

CODE	DESCRIPTION
914-PARJ-108	6 x 108 in. step beam (rear beams)
413-D2-654A500	4 x 4 in. wood attachment for step beam

13/4 x 6 x 108 in. front beam with 4 deflectors and 4 L-shaped steel plate to fasten a 4 x 4 in. piece of wood

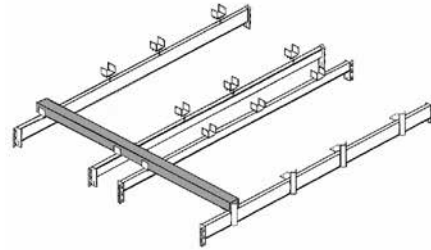

INSULATION BATTS STORAGE RAIL SYSTEM

CODE	DESCRIPTION
RAILALAIN102	102 in. L with 2 in. casters at the center (the outward ones in the picture) Require dropped beams to make a small slope

For the storage of insulation batts, when a skid is removed the next one will move forward and stop on the front stopper.

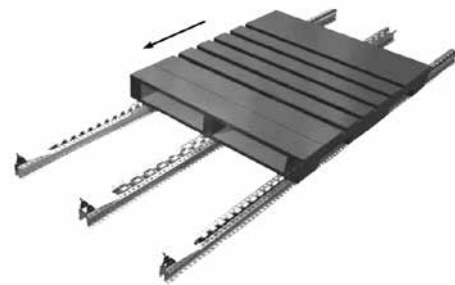

WAREHOUSE RACKING

VERSA-RACK

CODE	MEASURE (IN.)	DESCRIPTION
Upper bracket		
VRF-H2-0105	1 15/16 x 2 x 5 1/2	With hardware 1
Upright		
421-H1-0096	1 3/4 x 1 7/8 x 96 3/4	With lower bracket 2
Lower bracket		
VRF-H2-0005	1 15/16 x 2 x 5	With hardware 3
Shelf bracket		
VRS-03-0024	3 1/2 x 1 1/2 x 23 3/4	Hardware included with shelf supports
VRS-03-0030	3 1/2 x 1 1/2 x 29 3/4	
VRS-03-0036	3 1/2 x 1 1/2 x 35 3/4	
VRS-03-0048	3 1/2 x 1 1/2 x 47 3/4	

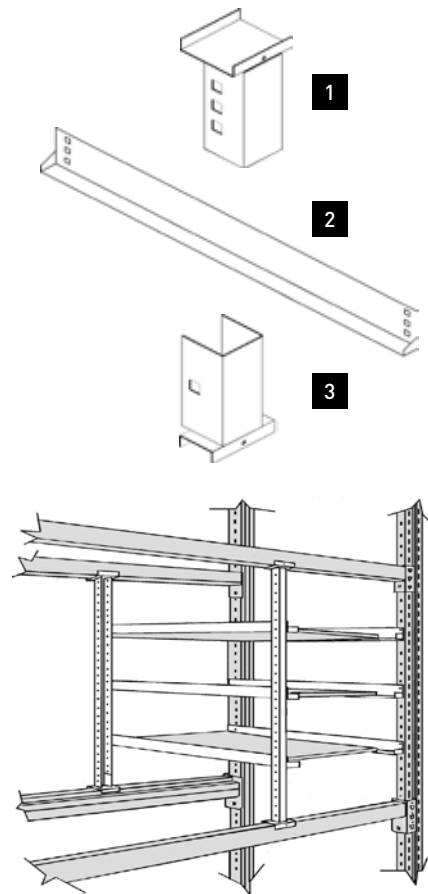

BRACKETS

CODE	DESCRIPTION
TEAR DROP	
947VH01M06	Tear drop type, vertical post divider adjustable top adaptor
947VH01M07A400	Tear drop type, vertical post divider adjustable bottom adaptor
R SERIES	
925Y0010RB	R type, vertical post divider adjustable bottom adaptor
925Y0010RH	R type, vertical post divider adjustable top adaptor
H SERIES	
925Y0010HB	H type, vertical post divider adjustable bottom adaptor
925Y0010HH	H type, vertical post divider adjustable top adaptor

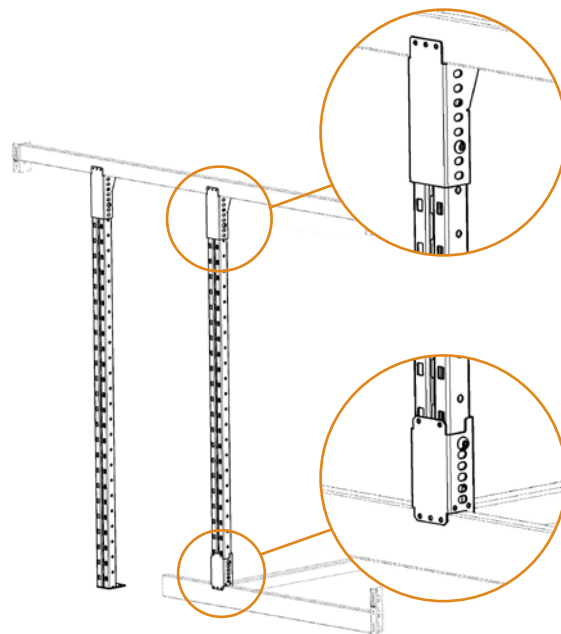

DISPLAYS

BROOM AND HAMMER DISPLAY

CODE	MEASURE (IN.)
------	---------------

R SERIES with label holder

410-01-0020A	20
410-01-0030A	30

H SERIES with label holder

410-H1-0020A	20
410-H1-0030A	30

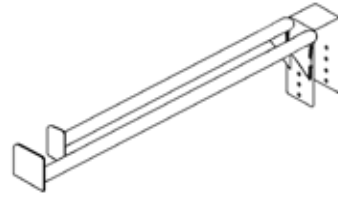

SLEDGEHAMMER DISPLAY

CODE	MEASURE (IN.)
------	---------------

R SERIES with label holder

410-01-0120	20
410-01-0130	30

H SERIES with label holder

410-H1-0120	20
410-H1-0130	30

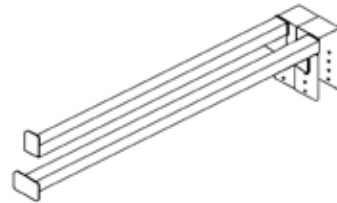

HACKSAW AND METAL SAW DISPLAY

CODE	MEASURE (IN.)
------	---------------

410H10330A	30
410H10320A	20

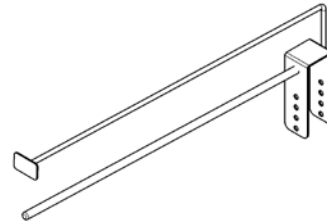

CHAIR DISPLAY

CODE	DESCRIPTION
------	-------------

410H10542C	H Series
------------	----------

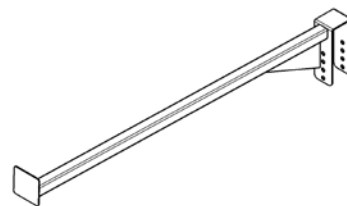

CARLON DISPLAY

CODE	MEASURE (IN.)
------	---------------

R SERIES

410-01-0520	20
410-01-0530	30

H SERIES

410-H1-0520	20
410-H1-0530	30

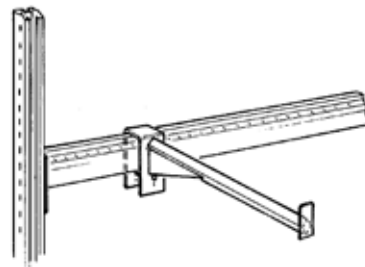

DISPLAYS

CARLON DISPLAY

CODE	MEASURE (IN.)
------	---------------

R SERIES with label holder

410-01-1120	20
-------------	----

410-01-1130	30
-------------	----

H SERIES with label holder

410-H1-1120	20
-------------	----

410-H1-1130	30
-------------	----

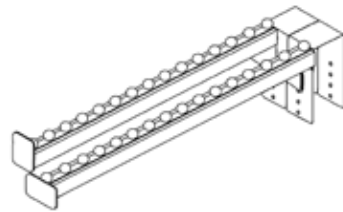

GARDEN HOSE DISPLAY

CODE

R SERIES

M505188A502

H SERIES

M505188A501

27 3/4 in. long, with 1 1/4 in. H x 2 in. W label holder, to be installed on 4 in. step beam



EDGE TRIMMER DISPLAY - R SERIES OR H

CODE	DESCRIPTION
------	-------------

496-05-05-A800	Including: C-shaped adaptor 29 in. perforated upright Edge-trimmer bracket (3/8 in. rod) Hardware
----------------	---

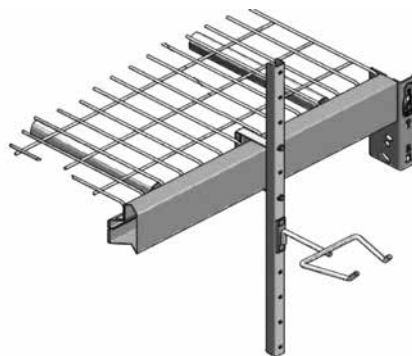

DISPLAYS

PHARMACY DISPLAY

CODE	DESCRIPTION AND MEASURE (IN.)
495 3605 A 800	Medecine cabinet display to be installed on a 3 1/4 in. high R-Series step beam either reversed or recessed 5 W x 5 D x 12 in. H, 14 ga with hardware

Including

495 3605 A700	Medecine cabinet display (1 x)
700-1-3812	3/8 in. -16 x 1 in. bolt - GR 2 zinc (2 x)
700-2-382	3/8 in. -16 flange nut - GR 2 zinc (2 x)
700-7-858	#8 x 5/8 in. wood screw (4 x)
001-00-0002	Leveler - to lock into place (2 x)

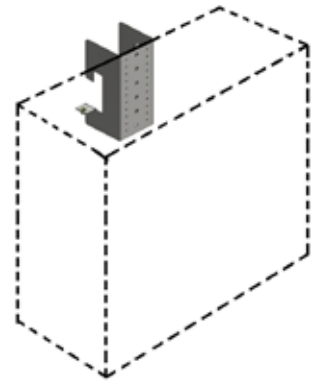

VANITY DISPLAY

CODE	DESCRIPTION AND MEASURE (IN.)
495 3605 A 801	Vanity display to be installed on a 3 1/4 in. high R-Series step beam either reversed or recessed 5 W x 5 D x 12 in. H, 14 ga with hardware

Including

495 3605 A700	Vanity display (1 x)
700-1-3812	3/8 in. -16 x 1 in. bolt - GR 2 zinc (2 x)
700-2-382	3/8 in. -16 flange nut - GR 2 zinc (2 x)
700-7-7858	#8 x 5/8 in. wood screw (4 x)
001-0-0002	Leveler - to lock into place (2 x)
495 4801 A402	18 in. support arm without steel plate (1 x)
495 4801 A501	Adjustable support arm (1 x)
495 4801 A400	3 1/4 x 13/16 x 2 1/2 in. locking bracket (1 x)
700-1-14152	1/4 in.-20 x 1 1/2 in. bolt - GR 2 zinc (8 x)
700-2-3813	1/4 in.-20 nut - GR 2 zinc (8 x)

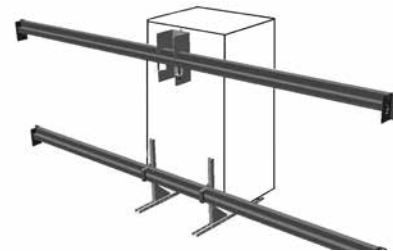

DISPLAYS

BATHROOM SINK DISPLAY

CODE	DESCRIPTION AND MEASURE (IN.)
495 3605 A 802	Bathroom sink display to be installed on a 3 1/4 in. high R-Series step beam either reversed or recessed 5 W x 5 D x 12 in. H, 14 ga with hardware

Including

495 3605 A700	Bathroom sink display (1 x)
495 3605 A403	L-shaped bracket (pivot) (1 x)
70013812	3/8 in. -16 x 1 in. bolt - GR 2 zinc (2 x)
70013832	3/8 in. -16 flange nut - GR 2 zinc (2 x)
7002382	3/8 in. -16 flange nut - GR 2 zinc (2 x)
ROSI150430	White Sintra divider (1 x) 1/2 in. thick x 2 3/4 in. diameter
001-0-0002	Leveler - to lock into place (2 x)



KITCHEN SINK DISPLAY

CODE	DESCRIPTION AND MEASURE (IN.)
495 3605 A 803	Kitchen sink display ajustable from 12 to 24 in. high to be installed on a 3 1/4 in. high R-Series step beam

Including

M1502 1430 A702	Lower sink bracket (2 x)
M1502 1430 A511	Upper sink bracket (2 x)
M1502 1430 A704	U-shaped part for the upper (2 x)
043-21-03121	10-32 x 1/2 in. button head bolt (4 x)
700-2-103201	10-32 nut (6 x)
700-0-111032135	10-32 x 1 3/4 in. button head bolt (2 x)
700-4-38252	3/8 x 2 1/2 in. carriage bolt (6 x)

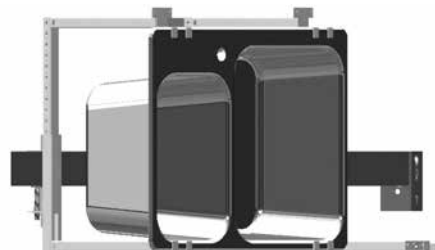

SIGNAGE HOLDER FOR SINK

CODE	DESCRIPTION AND MEASURE (IN.)
M15055431A500	11 in. long, 4 x 4 in. steel plate to be installed on a R Series step beam

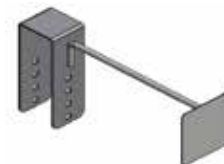

DISPLAYS

BATH DISPLAY

CODE	DESCRIPTION AND MEASURE (IN.)
495 3605 A 804	Bath display with one upper bracket only one lower support arm To be installed on a 3 1/4 in. high R-Series step beam 5 L x 5 D x 12 H, 14 ga with hardware

Including

495 3605 A700	Bath display (1 x)
700-1-3832	3/8 in. -16 x 3 in. bolt - GR 2 zinc (1 x)
700-2-382	3/8 in. -16 flange nut - GR 2 zinc (1 x)
001-00-0002	Leveler - to lock into place (3 x)
495 4801 A502	23 in. support arm with 2 7/8 in. steel plate (1 x)
495 4801 A501	Adjustable support arm for bath (1 x)
495 4801 A702	1 x 1 9/16 x 1 x 3 in. U-shaped part with insert for leveler (1 x)
495 4801 A400	3 1/4 x 13/16 x 2 1/2 in. locking bracket (1 x)
700-1-14152	1/4 in. - 20 x 1 1/2 in. bolt - GR 2 zinc (8 x)
700-2-3813	1/4 in. - 20 nut - GR 2 zinc (8 x)
ROSI150430	White Sintra divider (4 x) 1/2 in. thick x 2 3/4 in. diameter

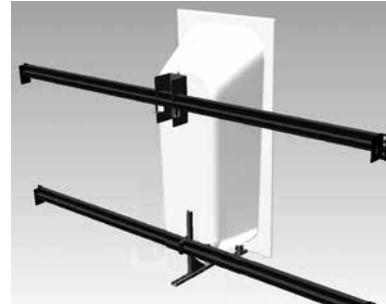

SIGNAGE HOLDER FOR SINK

CODE	DESCRIPTION AND MEASURE (IN.)
M15065938A500	24 in. long, 4 x 4 in. steel plate to be installed on R Series step beam



ANGLED SIGNAGE HOLDER FOR SINK

CODE	DESCRIPTION AND MEASURE (IN.)
M15065938A501	24 in. long, 4 x 4 in. steel plate to be installed on R Series step beam



DISPLAYS

TOILET DISPLAY

CODE	MEASURE (IN.)
------	---------------

R SERIES

410-02-1609	16 1/2 x 9 1/4
-------------	----------------

H SERIES

410-H2-1609	16 1/2 x 9 1/4
-------------	----------------

To be installed on a 4 in. step beam



SIGNAGE HOLDER FOR TOILET

CODE	DESCRIPTION AND MEASURE (IN.)
------	-------------------------------

M22115695A500	18 in. long, 4 x 7 in. steel plate to be installed on R Series step beam
---------------	---

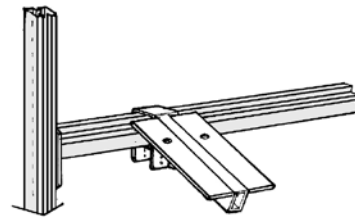

ANGLED SIGNAGE HOLDER FOR TOILET

CODE	DESCRIPTION AND MEASURE (IN.)
------	-------------------------------

M14100797A500	18 in. long, 4 x 4 in. steel plate to be installed on R Series step beam
---------------	---

M22115695A500	18 in. long, 4 x 7 in. steel plate to be installed on R Series step beam
---------------	---

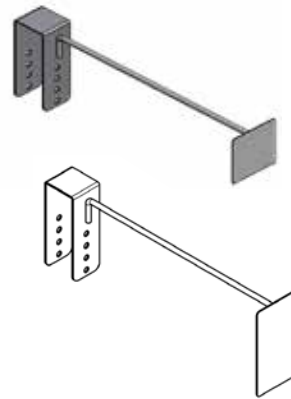

TOILET SEAT DISPLAY BEAM NOT INCLUDED

CODE	MEASURE (IN.)
------	---------------

R SERIES

410-02-0096	96
-------------	----

410-02-0102	102
-------------	-----

H SERIES

410-H2-0096	96
-------------	----

410-H2-0102	102
-------------	-----

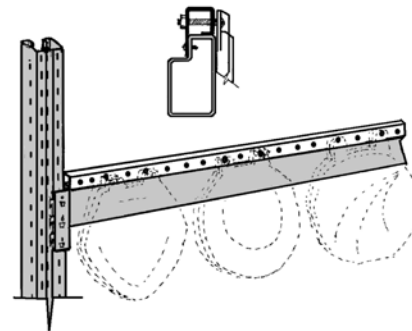

PLUMBING

FLEX FACADE FOR SAMPLE

CODE	DESCRIPTION AND MEASURE (IN.)
------	-------------------------------

Removable identification facade for plumbing sample or other types (in 2 parts), includes attachments and hardware

410-03-0096	For 96 in. beam (95 3/4 in.)
-------------	------------------------------

Including

M13120130A400	47 1/2 in. removable facade (2 x)
M13120130A401	Facade holder (4 x)
700-6-858	#8 5/8 in. self-taping screw (8 x)
M13120130A402	95 3/4 in. installation template (metal)

410-03-0096	For 102 in. beam (101 3/4 in.)
-------------	--------------------------------

Including

M14021393A400	50 7/8 in. removable facade (2 x)
M13120130A401	Facade holder (4 x)
700-6-858	#8 5/8 in. self-taping screw (8 x)
M14021393A402	101 3/4 in. installation template (metal)



CEILING LIGHT AND FAN DISPLAYS

ATTACHED TO THE GONDOLA'S UPRIGHTS

DESCRIPTION

SPECIAL ORDER

WARNING! Under no circumstance can a person walk on top of the display



SUSPENDED FROM THE CEILING

DESCRIPTION

SPECIAL ORDER

WARNING! Under no circumstance can a person walk on top of the display

Capacity: 50 lb per square foot



ATTACHED TO THE WAREHOUSE FRAMES

DESCRIPTION

SPECIAL ORDER

WARNING! Under no circumstance can a person walk on top of the display

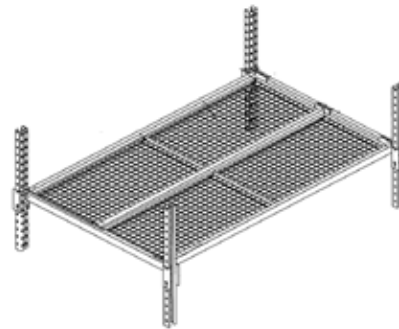

SUSPENDED FROM THE CEILING WITH ELECTRICAL BOX FOR DOUBLE POWER OUTLETS

CODE	MEASURE (IN.)	DESCRIPTION	
M15085674A503	42 L x 96 L	8 boxes - 1 x 2 in. spacing	1
M15085674A505	42 L x 72 L	8 boxes - 1 x 2 in. spacing	1
M15085674A504	42 L x 48 L	6 boxes - 1 x 2 in. spacing	1
M13101201A500	42 L x 96 L	8 boxes - 2 x 2 in. spacing	2

WARNING! Under no circumstance can a person walk on top of the display

Capacity: 30 lb per square foot

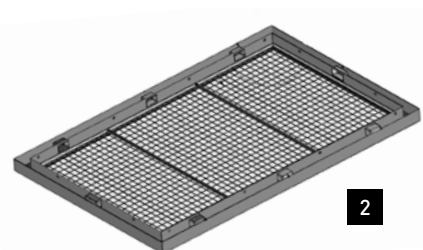
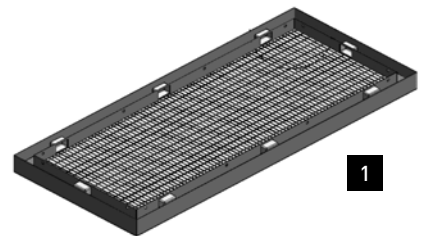

HARDWARE FOR CEILING LIGHT AND FAN DISPLAYS

BEAM - C3 X 4.1

CODE	MEASURE (IN.)	DESCRIPTION
404-00-0084	84 L	To suspend to the roof trusses, painted polar white (4 per display)

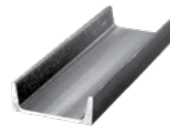

ATTACHMENT FOR BEAM - C3 X 4.1

CODE	MEASURE (IN.)	DESCRIPTION
404-05-0002	84 L	To avoid the slippage of beams, painted polar white (2 per beam)

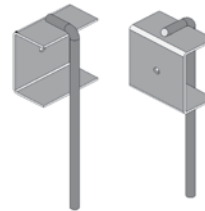

AVIATION GRADE STEEL CABLE - TYPE 7 X 7

CODE	MEASURE (IN.)	DESCRIPTION
CABLEAVIATION	1/8 x 15 ft	Galvanized finish 6 lengths per display

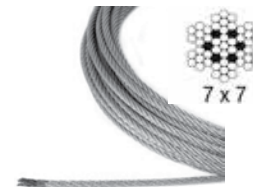

STEEL CABLE TIE

CODE	MEASURE (IN.)	DESCRIPTION
SERRECABLE	1/8 dia.	Galvanized finish 4 per cable



TUMBUCKLE

CODE	MEASURE (IN.)	DESCRIPTION
043-00-0007	3/8 x 6	1 per cable



QUICK LINK

CODE	MEASURE (IN.)	DESCRIPTION
MAILLEPATENTE14	1/4	1 per cable



DISPLAYS

VERTICAL SPOOL DISPLAY

To be installed on a 4 in. step beam at the base and a 4 in. step beam at the top (sold separately)

CODE	MEASURE (IN.)	DESCRIPTION
421-01-G096	96	Left upright
421-01-C096	96	Center upright
421-01-D096	96	Right upright
VRF-H2-0105	1 15/16 x 2 x 5 1/2	Upper bracket
030-18-0001	-	Rod holder
406-01-5818	18 x 5/8 rod	To be cut on site if necessary

Other heights available on request



LONG SLOPED SPOOL DISPLAY

R SERIES - 17 ft. L

CODE	MEASURE (IN.)	
PBF-R-24204	For 24 in. D warehouse section	15 rods of 60 in.
PBF-R-30204	For 30 in. D warehouse section	17 rods of 60 in.
PBF-R-36204	For 36 in. D warehouse section	20 rods of 60 in.



LARGE SPOOL DISPLAY ON CASTERS

CODE	MEASURE (IN.)
406-02-2415	24 D x 15 H

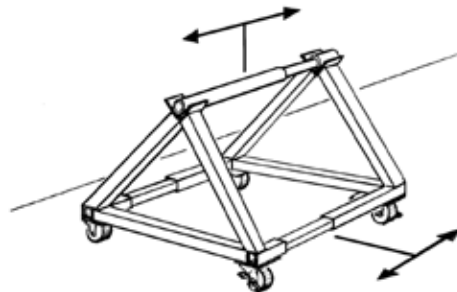

ACCESSORIES

MOBILE STAND FOR MEASURER AND REEL

CODE	MEASURE (IN.)	DESCRIPTION
406-03-0000	37 H x 32 L	20 in. base on 2 in. dia. casters



METER

CODE	DESCRIPTION	
016-21-0000	Metric model #1420	
016-21-0000A	Imperial model #1410 and #1420	SPECIAL ORDER



METER

CODE	DESCRIPTION	
016-21-0000B	Imperial model #1430 for rope	SPECIAL ORDER



CUTTER

CODE	
016-21-0100	



SPOOLER

CODE	DESCRIPTION
016-21-0001	Model 99



DISPLAYS

LIGHTING FIXTURES DISPLAY PANEL 14 x 14 in.

AVAILABLE CONFIGURATIONS	AVAILABLE LENGTHS (IN.)
1 level high	
2 levels high	45 1/2, 48, 56 1/2, 60, 68 1/2, 72, 80 1/2, 84,
3 levels high	92 1/2, 96, 97, 98, 99, 99 1/2, 102, 116 1/2,
4 levels high	120, 140 1/2, 144
5 levels high	

Each kit includes:

Left and right bracket, lower tube, upper tube, centre tube(s), combination of 14 x 14 in. melamine panels and fillers

Melamine panels comes either:

with 3 grooves, with octagonal hole or plain

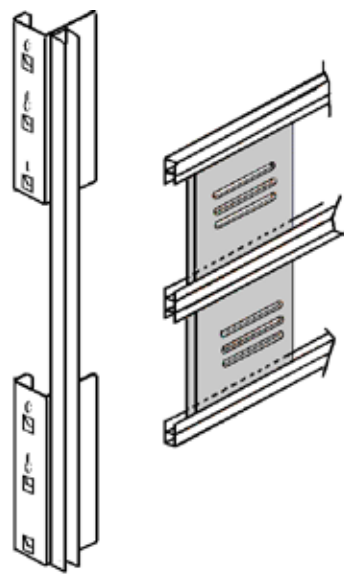

SUSPENDED CEILING TRACK DISPLAY

CODE	MEASURE (IN.)	DESCRIPTION
410-20-G050510	10 L x 10 H x 5 D	Left
410-20-D050510	10 L x 10 H x 5 D	Right
410-20-C050510	10 L x 10 H x 5 D	Center



DISPLAYS

CEILING FAN DISPLAY

CODE	DESCRIPTION AND MEASURE (IN.)
------	-------------------------------

24 x 36 in., +/- 106 in. high ceiling fan display on heavy-duty base on levellers

Including

013-02-3624	24 x 36 in. heavy-duty base with levelers (1 x)
M14110955A500	Fan display in 3 x 3 in. square tubing, with upper and lower attachments 99 7/8 in. high (1 x)
700-6-14101	1/4 x 1 in. Tek screw (5 x)
001-00-0002	3/8 in. leveler (6 x)

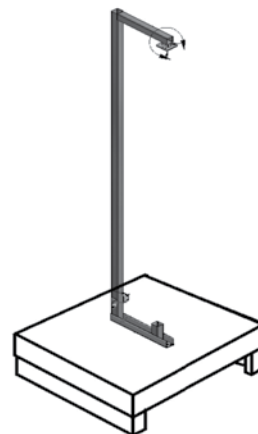

LED FLUORESCENT LIGHT FIXTURE

CODE	MEASURE (IN.)	DESCRIPTION
------	---------------	-------------

SLIM46LED	44 5/8 (4500 K)	LED fixture
SLIM34LED	32 5/8 (4500 K)	LED fixture
SLIM22LED	20 5/8 (4500 K)	LED fixture
INTERCONLED20	20	Interconnection cable
POWERCORDSLIMLED	78 (2 m)	Power cable



DISPLAYS

RUG DISPLAY

FRAMES NOT INCLUDED

CODE	DESCRIPTION AND MEASURE (IN.)
407-00-6102	Lower carpet beam 6 x 102 in.
407-01-6102	Upper carpet beam 6 x 102 in.
407-02-7848B	Carpet page, 48 in. H x 78 in. L in square tubing (requires carpet clip) Mark III
407-02-0000	Carpet clip
407-03-0000	Cross bracing for 102 in. opening (between the upright)
407-00-2102	Safety tube for carpet page 1 1/2 x 1 1/2 x 0.100 x 102 in.
407-00-4838	Carpet rolls display 46 1/2 in. L x 48 in D x 38 in. H built in two pieces
407-02-7848	Carpet page (<i>old model</i>), 48 in. H x 78 in. L in round tubing Mark II
407-02-7209	Carpet page (<i>old model</i>), 102 in. H x 72 in. L in square tubing Mark I (circa 1990, early 2000)

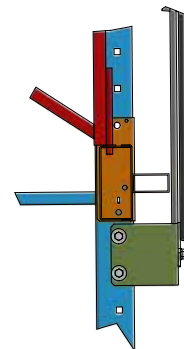
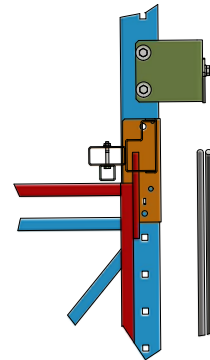
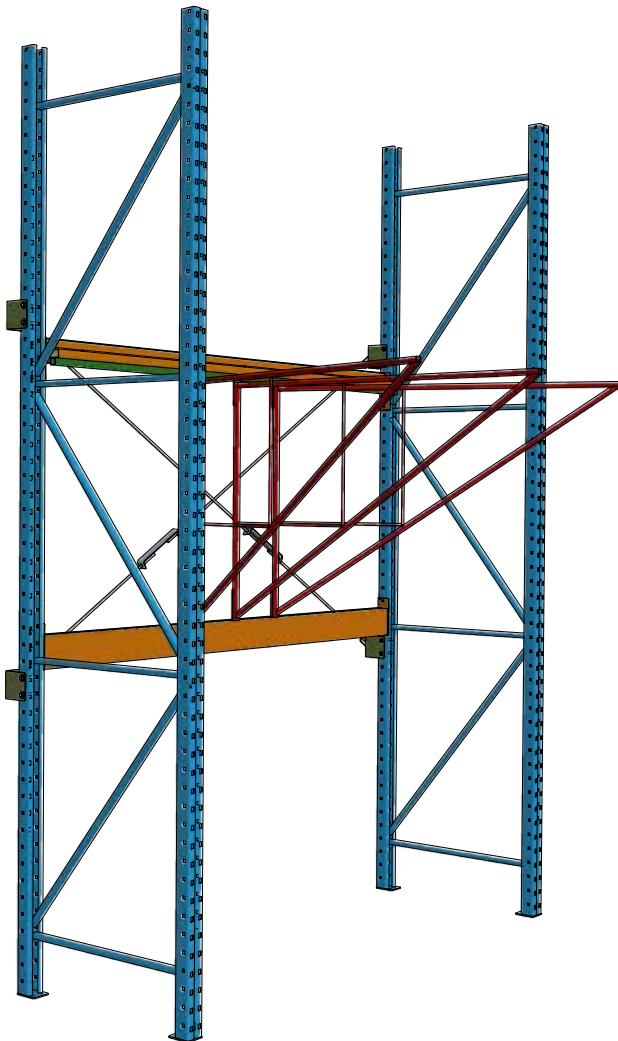

DISPLAYS

CARPET DISPLAY

CODE	DESCRIPTION AND MEASURE (IN.)	QTY
M-12030642A502	Angled base to accommodate mat page 36 in. D to be fixed on R Series beam to the back	1
M-12030642A501	Angled base to accommodate mat page 36 in. D to be fixed on R Series beam to the back	1
M-12030642A400	Safety tube to prevent pages unhooking 1 x 1 x 38 1/4 in. with 2 1/2 in. holes	1
M-12030642A500	Mat page 71 in. D x 48 in. H, square and round tube, no clamp required	5

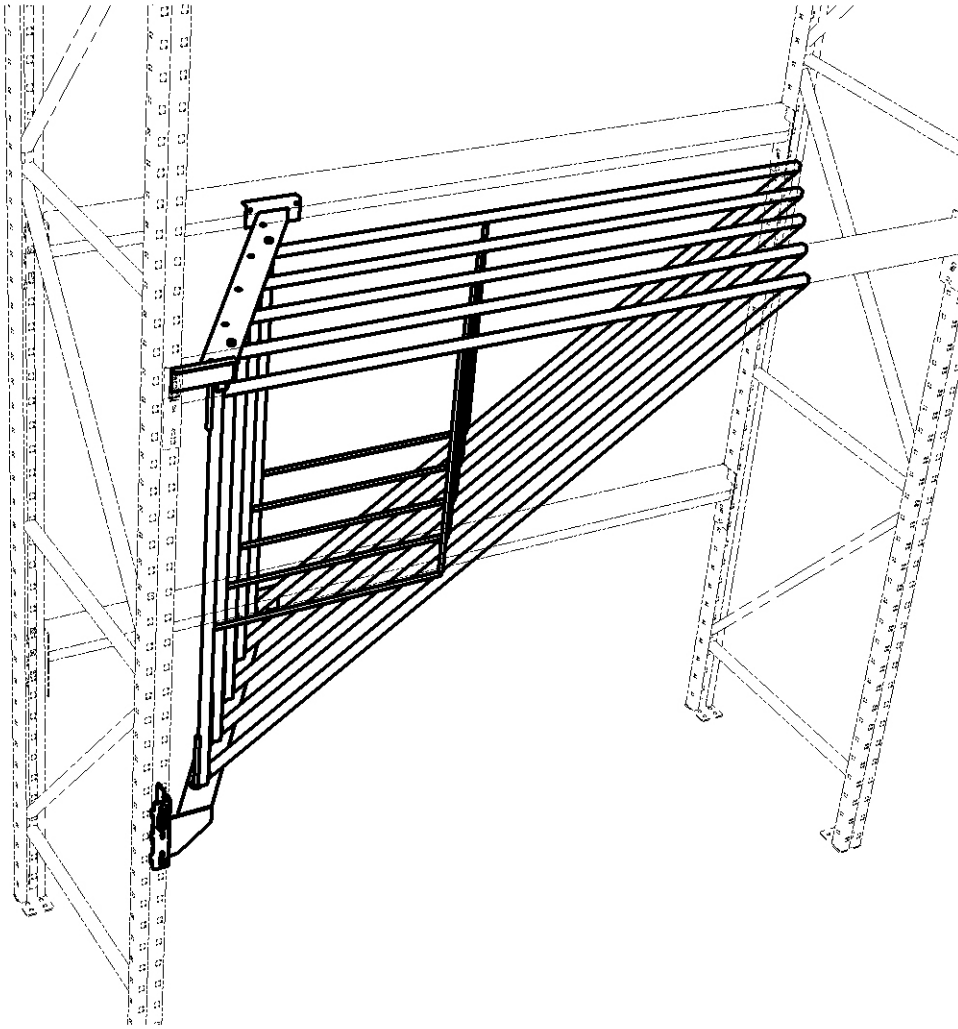

CARPET DISPLAYS

CARPET DISPLAY

CODE	DESCRIPTION AND MEASURE (IN.)
------	-------------------------------

For 36 in. deep warehouse section, width adjustable from 96 to 102 in.

48 moulding dividers of 30 in. deep (for 36 in. deep frames are required, must be ordered separately)

Including

M1408 1022 402	3 x 3 x 94 x 1/8 in. HSS tubing (1 x)
M1408 1022 502	Reversible carpet holder (16 x)
M1408 1022 503	29 3/8 in. lateral bracket - male (2 x)
M1408 1022 501	28 3/8 in. left lateral bracket - female (1 x)
M1408 1022 500	28 3/8 in. right lateral bracket - female (1 x)
M1408 1022 401	Left tube holder (1 x)
M1408 1022 400	Right tube holder (1 x)
700-2-516203	5/16 in. -18 flange nut - GR 2 zinc (16 x)
700-2-382	3/8 in. -16 flange nut - GR 2 zinc (16 x)
700-1-51642	5/16 in. -18 x 4 in. bolt - GR 2 zinc (16 x)
700-1-3812	3/8 in. -16 x 1 in. bolt - GR 2 zinc (4 x)
700-1-383125	3/8 in. -16 x 3 1/2 in. bolt - GR 2 zinc (4 x)
700-1-3845	3/8 in. -16 x 4 in. bolt - GR 2 zinc (8 x)

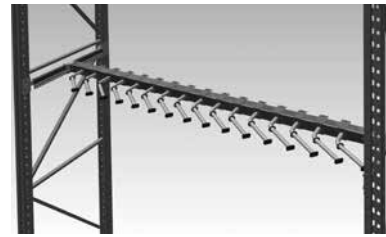

CARPET DISPLAY BRACKET - 5 x 9 ft.

CODE	DESCRIPTION AND MEASURE (IN.)
------	-------------------------------

Including

M14110957A400	Mounting bracket for 6 in. step beam (2 x)
M14110957A402	1 1/4 x 4 x 1 in. L-shaped clip with one hole (2 x)
M14110957A401	1 x 2 x 66 in. tube with rear attachment (1 x)
700-6-101	Self-taping Tek screw (10 x)
407-02-0000	Requires 6 carpet clips for each kit (not included)



FLOORING DISPLAYS

SLOPED FLOORING DISPLAY

CODE	DESCRIPTION	SPECIAL ORDER
925M484860	Upright 48 in.D x front 48 in. H x back 60 in. H	

Rectangular door required
Regular beam required



FLOORING DISPLAY SIGN HOLDER

CODE	MEASURE (IN.)	
M16025669A502	7	Right upright extension
A16025669A501	7	Left upright extension
A16025669A500	7	Center upright extension
A16025669A500	6 x 96	Signage holder
A16025669A505	6 x 102	Right upright extension

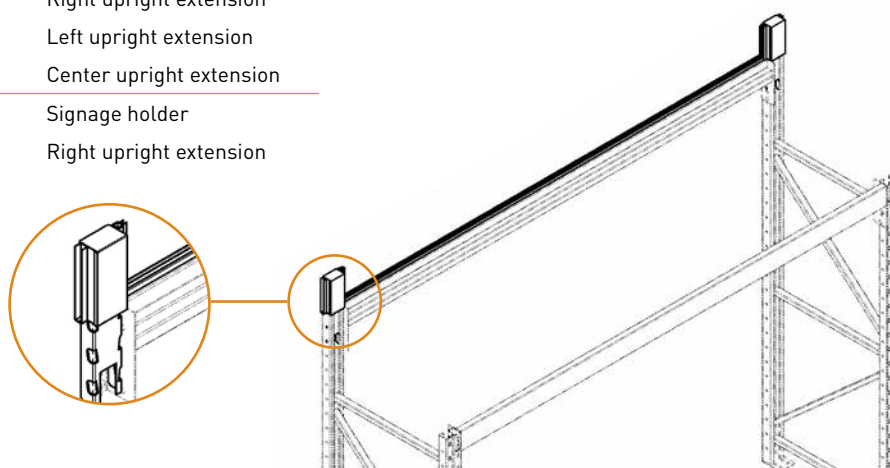

MOSAIC STYLE HARDWOOD FLOORING DISPLAY

CODE	DESCRIPTION AND MEASURE (IN.)
FRAME FOR HARDWOOD FLOORING	
36 H in. x 96 L in., mosaic style	

Including

70013815	3/8 in. -16 bolt - GR 2 zinc
7003122	1/2 in. flat washer - GR 2 zinc
aes37h115	Maxtite 3/8 in. - 16 standard full-hex grip
496024001a500	37 in. right bracket for floor frame
496024001a501	37 in. left bracket for floor frame
M1408 1022 401	Left bracket tubing (1 x)
496024001a700	Kit for floor frame 36 13/16 x 94 9/16 in. (Maxtite)

Specify the width of the bay when ordering to receive the correct size filler pieces



FLOORING DISPLAYS

SLOPED FLOORING DISPLAY

CODE	MEASURE (IN.)	DESCRIPTION
496-28-3654	2 x 38 x 54 H	Unassembled



VERTICAL FLOORING DISPLAY

CODE	MEASURE (IN.)	DESCRIPTION
M8070246A401	1 1/2 x 2 x 1 1/2 x 96	60° U-shaped crossbar with 3 holes for fasteners
M8070246A400	3 x 3 1/8 x 1 1/2 X 1 3/4 x 2 1/2 x 96	60° S-shaped crossbar with 3 holes for fasteners



FLOORING DISPLAYS

SLOPED CERAMIC DISPLAY

AVAILABLE IN R AND H SERIES

CODE	MEASURE (IN.)	
914T14102	11 3/4 x 4 x 102	Recessed step beam
914T14096	11 3/4 x 4 x 96	Recessed step beam
4100118102	102	Sloped ceramic display
4100118096	96	Sloped ceramic display

Includes: 1-recessed 11 3/4 in. step beam the width of the bay,
1-Sloped display and hardware

Note: A regular 4 in. step beam is required for the sloped display



MOSAIC TILE DISPLAY

CODE	DESCRIPTION
496014096A80096	96 in. section components
496014001A401	102 in. section spacer

Display for 21 samples of mosaic tiles
1-level of 12 in. and 2-levels of 6 in.



VERTICAL FLOORING SAMPLE DISPLAY

CODE	MEASURE (IN.)	DESCRIPTION
410-30-3653J	36 L x 54 H	
410-30-3672	36 L x 72 H	
410-303036-A400	36	Display cap
M1103 0869K	5 x 4 x 35 3/4	Wire basket with brackets

For product sample presentation on pallets



MISCELLANEOUS

ROLLING CERAMIC CART

Includes the top in plywood and 4 heavy duty casters

CODE	MEASURE (IN.)	DESCRIPTION
PLATE5238	52 L x 38 D	
PLATE4038	40 L x 38 D	
M1306 0120 A500	1 x 1	Pull-bar



SWIVEL DOOR FOR CASH COUNTER ACCESS AND IMPULSIVE SALE PRODUCTS

SPECIAL ORDER



DISPLAYS

DOOR HANDLES AND/OR LOCKS DISPLAY

CODE	DESCRIPTION AND MEASURE (IN.)
Backpanel for handle and/or lock NOT INCLUDED	
410-08-1201	Universal: for 8 or 12 small blocks adjustable from 96 to 102 in.
Including	
M1702 5036 A500	Side attachment, to be fixed to the frame (2 x)
700 SBF A401	7/16 x 1 7/8 in. Chicago bolt Allan head - female GR 5 zinc (4x)
700 SBM A400	7/16 x 3 in. Chicago bolt Allan head - male GR 5 zinc (4x)
M1702 5036 A401	2 x 2 x 94 in. C-shaped crossbar - 6, 8 and 12 blocks (2x)
700-2-382	3/8 in. -16 -flange nut GR 2 zinc (4x)
700-1-3812	3/8 -16 x 1 in. bolt GR 2 zinc (4x)
700-6-8321201	8-32 x 1/2 in. Robertson flat head screw (24x)
700-2-832	8-32 screw (24x)

Universal: for 6 big blocks adjustable from 96 to 102 in.

Including	
M1702 5036 A501	Side attachment, to be fixed to the frame (2 x)
700 SBF A401	7/16 x 1 7/8 in. Chicago bolt Allan head - female GR 5 zinc (4x)
700 SBM A400	7/16 x 3 in. Chicago bolt Allan head - male GR 5 zinc (4x)
M1702 5036 A401	2 x 2 x 94 in. C-shaped crossbar - 6, 8 and 12 blocks (2x)
700-2-382	3/8 in. -16 -flange nut GR 2 zinc (4x)
700-1-3812	3/8 -16 x 1 in. bolt GR 2 zinc (4x)
700-6-8321201	8-32 x 1/2 in. Robertson flat head screw (12x)
700-2-832	8-32 screw (12x)



SLIDING DOOR AND PANEL DISPLAY

SLIDING FRONT TO BACK

DESCRIPTION

SPECIAL ORDER

Since different track heights are available, both exterior doors with frames and interior doors of different heights can be displayed.

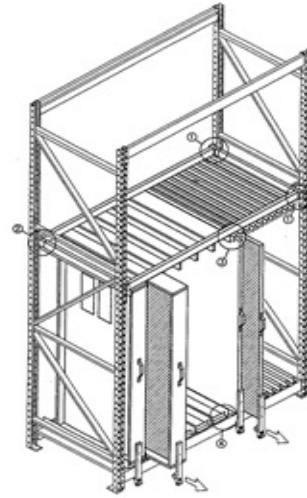

SLIDING FRONT TO BACK

DESCRIPTION

SPECIAL ORDER

This system is fastened to the floor and under the top beams
Can be installed onto a 30 to 42 in. deep section

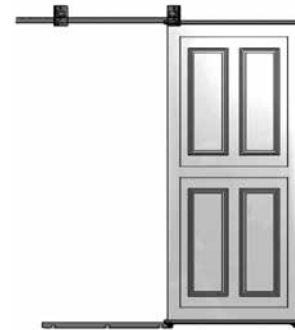

BARREL HOLDER

CODE	MEASURE (IN.)
------	---------------

404-02-0042	42 D
-------------	------

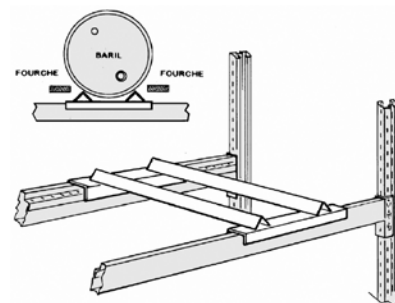

DISPLAYS

CARLON SPOOL DISPLAY

CODE

36 D x 36 L

410-00-0103	Bracket and adaptor for tube - Right
410-01-0103	Bracket and adaptor for tube - Left
410-00-3603	1 1/2 x 3 x 36 in. tube with bracket - Right
410-01-3603	1 1/2 x 3 x 36 in. tube with bracket - Left
410-01-0002	Central adaptor for 2 in. round Carlon tube
410-00-3602	2 x 38 3/4 in. round tubing

36 D x 48 L

410-00-0103	Bracket and adaptor for tube - Right
410-01-0103	Bracket and adaptor for tube - Left
410-00-3603	1 1/2 x 3 x 36 in. tube with bracket - Right
410-01-3603	1 1/2 x 3 x 36 in. tube with bracket - Left
410-01-0002	Central adaptor for 2 in. round Carlon tube
410-00-4802	2 x 48 in. round tubing

48 D x 36 L

410-00-0103	Bracket and adaptor for tube - Right
410-01-0103	Bracket and adaptor for tube - Left
410-00-4803	1 1/2 x 3 x 48 in. tube with bracket - Right
410-01-4803	1 1/2 x 3 x 48 in. tube with bracket - Left
410-01-0002	Central adaptor for 2 in. round Carlon tube
410-00-3602	2 x 38 3/4 in. round tubing

48 D x 48 L

410-00-0103	Bracket and adaptor for tube - Right
410-01-0103	Bracket and adaptor for tube - Left
410-00-4803	1 1/2 x 3 x 48 in. tube with bracket - Right
410-01-4803	1 1/2 x 3 x 48 in. tube with bracket - Left
410-01-0002	Central adaptor for 2 in. round Carlon tube
410-00-4802	2 x 48 in. round tubing

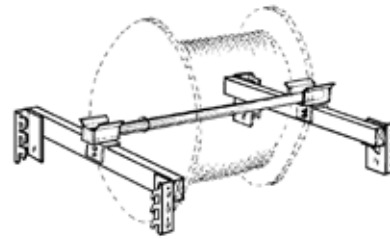

PALLET STYLE CARLON SPOOL DISPLAY

CODE

DESCRIPTION

410010548A800	On 4 x swivel casters of 5 in. diameter
---------------	---

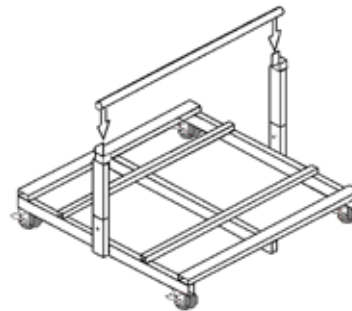

BRACKET FOR TUBING

CODE

MEASURE (IN.)

404-03-0001	For 1 3/16 tubing	Right
404-03-0011	For 1 3/16 tubing	Left
404-03-0001A	For 2 3/8 tubing	Right
404-03-0011A	For 2 3/8 tubing	Left



DISPLAYS

HOSEPIPE SPOOL DISPLAY

SPECIAL ORDER



ALUMINIUM SLATWALL PANEL SYSTEM INTEGRATED INTO A RACKING

DESCRIPTION

SPECIAL ORDER

Available in the following dimensions:
49 3/8, 97 3/8, 103 3/8 in. L
42, 48, 54, 60, 66, 72, 78, 84, 90, 96 in. H



ALUMINIUM SLATWALL PANEL

MEASURE (IN.)

Sold in 6 inch high slats Natural anodized finish

With the aid of adapters, can be inserted inside an existing structure

Can be powder-coated

A durable, aesthetic finish available in a wide range of colors

SPECIAL ORDER



TOOL SECTION ACCESSORIES

SLEDGEHAMMER DISPLAY

CODE	DESCRIPTION AND MEASURE (IN.)
410-01-0112	For slatwall or pegboard panel 10 in. L x 5 3/16 in. rear / 3 1/2 in. front, with rod for flip-scan type label holder 2 3/4 in. space between both sides

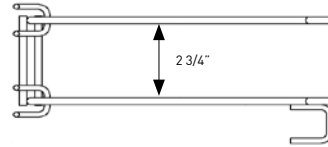

AXE DISPLAY

CODE	DESCRIPTION AND MEASURE (IN.)
410-01-1112	For slatwall or pegboard panel 10 in. L x 5 3/16 in. rear / 3 1/2 in. front, with rod for flip-scan type label holder 1 3/4 in. space between both sides

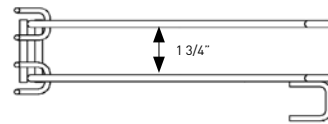

TOOL SECTION ACCESSORIES

WIRE MESH PANEL FOR POWER TOOL TABLE

CODE	MEASURE (IN.)	DESCRIPTION
495-01-2491E	24 H x 92 1/4 L	For 92 1/2 in. section
495-01-4891E	48 H x 92 1/4 L	For 92 1/2 in. section

Other dimensions available on request

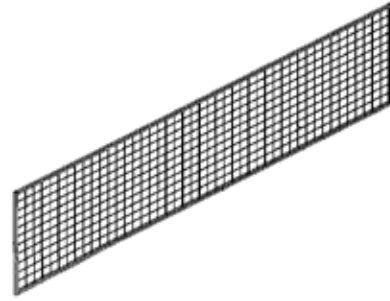

WIRE MESH PANEL ATTACHMENT

CODE	MEASURE (IN.)	DESCRIPTION
495-10-1212	12 H x 14 3/4 L	Central
495-10-G712	12 H x +/- 7 5/16 L	Left end
495-10-D712	12 H x +/- 7 5/16 L	Right end

1
2
2

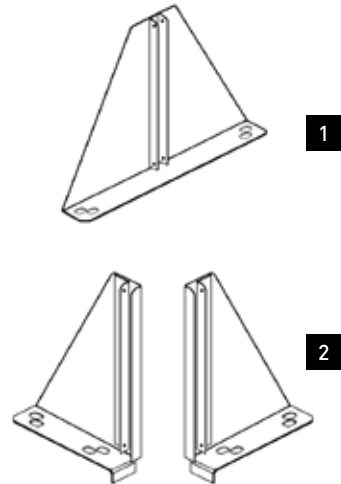

PERFORATED JUNCTION PANEL

CODE	MEASURE (IN.)
495-11-8P54JAE	54 1/2 L x +/- 8 23/32 L

Other dimensions available on request

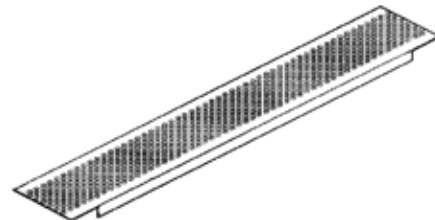

TOOL SECTION ACCESSORIES

DRILL DISPLAY

CODE	MEASURE (IN.)	DESCRIPTION
495-15-02J05	2 1/2 x 5	With 5/16 in. rod at 45° angle



BACK STOPPER FOR PERFORATED STEEL PANEL

CODE	MEASURE (IN.)	DESCRIPTION
495-12-1045R	10 H x 45 7/8 L	For divider with hooks and slots

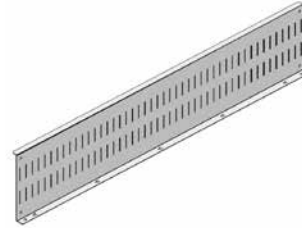

DIVIDER FOR DIVIDER BOX WITH HOOKS FOR PERFORATED STEEL PANEL

CODE	MEASURE (IN.)	DESCRIPTION
028-02-1316AD	16 x 1 1/4 x 10	Right
028-02-1321AD	21 x 1 1/4 x 10	Right
028-02-1316AG	16 x 1 1/4 x 10	Left
028-02-1321AG	21 x 1 1/4 x 10	Left

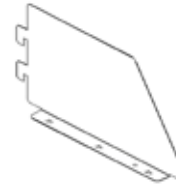

DISPLAYS

LAWN MOWER DISPLAY

CODE	MEASURE (IN.)	SPECIAL ORDER
------	---------------	---------------

M13061093A501 34 3/4 in. bottom rail with stopper

M13061093A500 40 3/4 in. bottom rail with stopper

Two tier:

First level at 18 in. from the ground, second level at 42 in. from the ground

Requires 34 in. deep warehouse frames

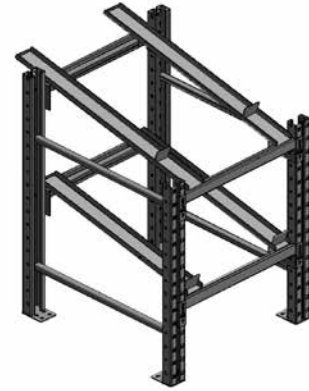

PATIO SLAB BRACKET

CODE	MEASURE (IN.)
------	---------------

410010003 10 L x 10 D x 14 H

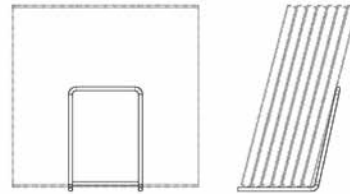

LOCKER DISPLAY FOR SAMPLE

CODE	MEASURE (IN.)
------	---------------

M22016025A500 20 x 2 x 6

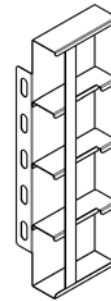

FLOOR SAMPLE DISPLAY FOR UPRIGHT

CODE	MEASURE (IN.)
------	---------------

M22095771A500

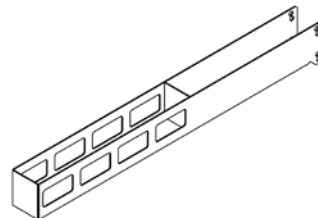

MEDIUM DUTY WAREHOUSING SYSTEM - WS TYPE

MEDIUM DUTY FRAME - WS TYPE

CODE	MEASURE (IN.)	DESCRIPTION
30201	24 D	Available heights: 48, 54, 60, 66, 72, 84, 90, 96, 102
	30 D	
	36 D	
	42 D	
	48 D	



MEDIUM DUTY STEP BEAM - TYPE WS AVAILABLE IN R SERIES OR H SERIES

CODE	MEASURE (IN.)	DESCRIPTION
R SERIES		
30202R	1 3/4	Maximum length of 102 in.
	2 1/2	
	3 1/4	
H SERIES		
30202	2	Available in the following lengths: 48, 54, 60, 66, 72, 78, 84, 90, 96, 102, 108, 114, 120
	3	

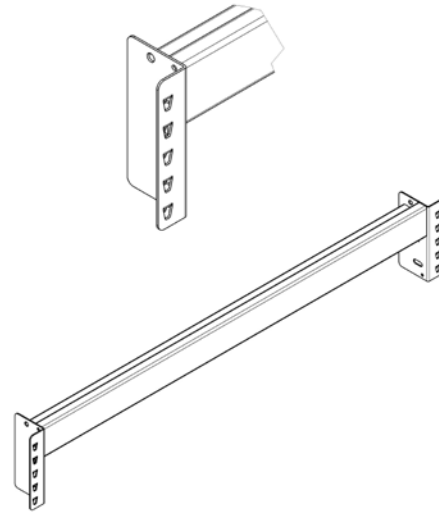

LIGHT DUTY WAREHOUSING SYSTEM

FRAME WITH OR WITHOUT LEVELER

CODE WITH LEVELER	CODE WITHOUT LEVELER	MEASURE (IN.)
300-01-6618A	300-01-6618	18 D x 66 H
300-01-6624A	300-01-6624	24 D x 66 H
300-01-6630A	300-01-6630	30 D x 66 H
300-01-7218A	300-01-7218	18 D x 72 H
300-01-7224A	300-01-7224	24 D x 72 H
300-01-7230A	300-01-7230	30 D x 72 H
300-01-8418A	300-01-8418	18 D x 84 H
300-01-8424A	300-01-8424	24 D x 84 H
300-01-8430A	300-01-8430	30 D x 84 H
300-01-9018A	300-01-9018	18 D x 90 H
300-01-9024A	300-01-9024	24 D x 90 H
300-01-9030A	300-01-9030	30 D x 90 H
300-01-9618A	300-01-9618	18 D x 96 H
300-01-9624A	300-01-9624	24 D x 96 H
300-01-9630A	300-01-9630	30 D x 96 H

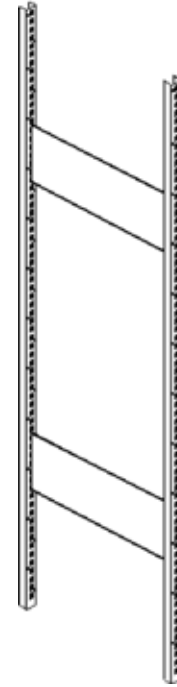

CROSS BRACING - MINIMUM 66 in. HIGH FRAME

CODE	MEASURE (IN.)	DESCRIPTION
300-03-0030	69 3/4	For 30 in. L section
300-03-0036	72 1/4	For 36 in. L section
300-03-0048	78 1/2	For 48 in. L section

Hardware included



LIGHT DUTY WAREHOUSING SYSTEM

PAINTED STEEL SHELF

CODE	MEASURE (IN.)
------	---------------

005-03-2418	18 x 24
-------------	---------

005-03-2424	24 x 24
-------------	---------

005-03-2430	30 x 24
-------------	---------

005-03-3018	18 x 30
-------------	---------

005-03-3024	24 x 30
-------------	---------

005-03-3030	30 x 30
-------------	---------

005-03-3618	18 x 36
-------------	---------

005-03-3624	24 x 36
-------------	---------

005-03-3630	30 x 36
-------------	---------

005-03-4818	18 x 48
-------------	---------

005-03-4824	24 x 48
-------------	---------

005-03-4830	30 x 48
-------------	---------



SHELF BRACKET

CODE	MEASURE (IN.)
------	---------------

300-02-0018	18
-------------	----

300-02-0024	24
-------------	----

300-02-0030	30
-------------	----



GALVANIZED SHELF

CODE	MEASURE (IN.)
------	---------------

027-03-0024	6 x 24
-------------	--------

027-03-0030	6 x 30
-------------	--------

027-03-0036	6 x 36
-------------	--------

027-03-0048	6 x 48
-------------	--------



SECURITY DOORS AND PANELS

DESCRIPTION

Swivel wire mesh doors, side and back panel to secure a storage section measuring 48 in. W x 2 in. D x 84 in. H

For wall section

Starter

Add-on

FOR BACK TO BACK SECTION - Back panel included

Starter

Add-on



WAREHOUSING SYSTEMS

MEZZANINE / STORAGE PLATFORM / PICK TOWER

SPECIAL ORDER



WAREHOUSING SYSTEM ON ROLLERS AND TRANSMOBILE

SPECIAL ORDER

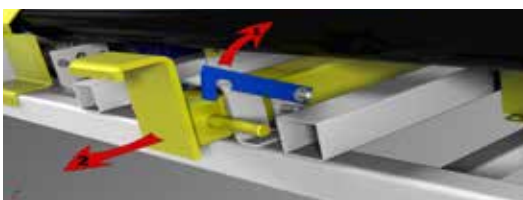

WAREHOUSING SYSTEMS

DRIVE-IN AND DRIVE-THRU TYPE WAREHOUSING SYSTEM

SPECIAL ORDER



PUSH-BACK TYPE WAREHOUSING SYSTEM

SPECIAL ORDER



STAIRS AND GUARDRAILS

MEZZANINE STAIRS

SPECIAL ORDER



TIP-UP GUARDRAIL

SPECIAL ORDER



MEZZANINE GUARDRAIL

SPECIAL ORDER



COMMERCIAL RACKING



COMMERCIAL RACKING

COMMERCIAL RACKING

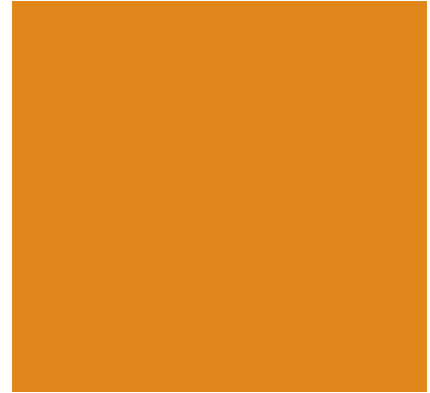

COMMERCIAL RACKING

COMMERCIAL RACKING



COMMERCIAL RACKING

DISPLAYS



MEZZANINES AND LUMBER YARDS







IN THIS SECTION

CASH COUNTERS

COSMETIC COUNTERS

SERVICE COUNTERS

**PHARMACY AND LABORATORY
COUNTERS**

CUSTOM-MADE COUNTERS

COUNTERS

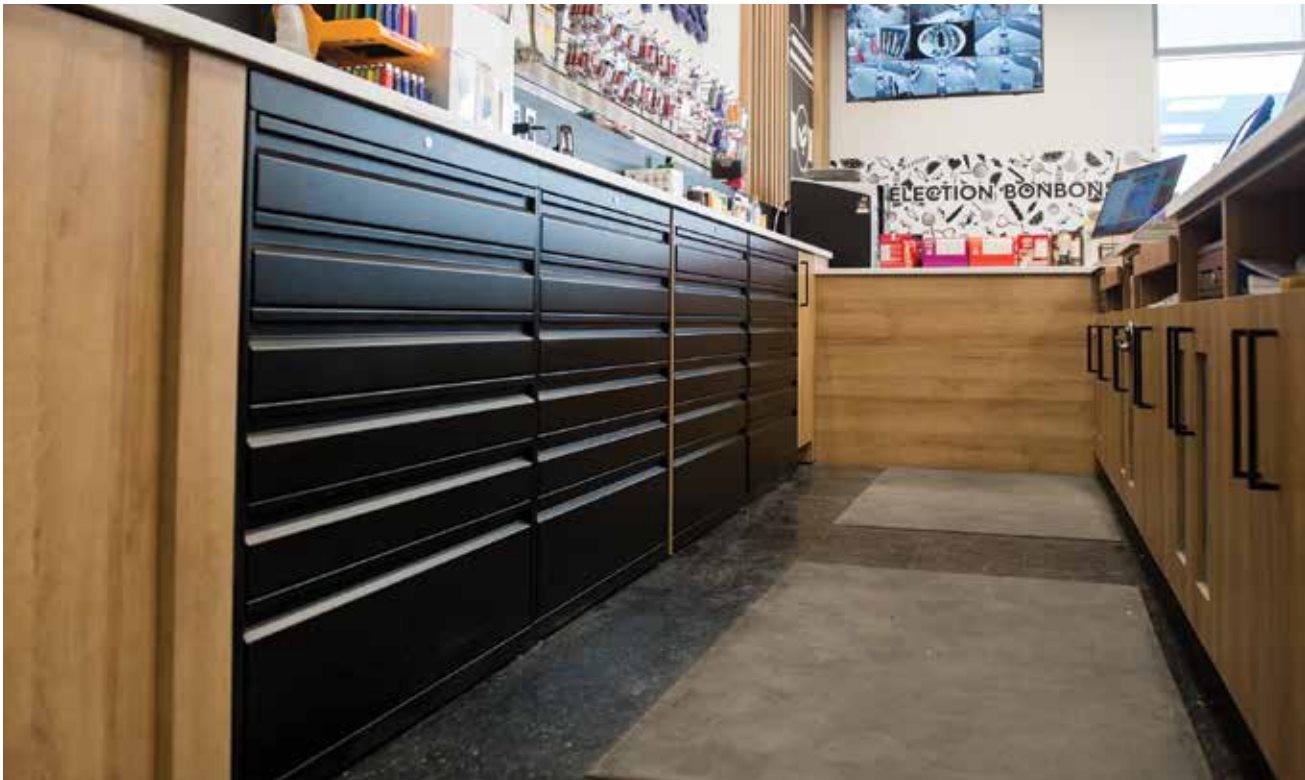



























IN THIS SECTION

4-SIDED DISPLAYS

COSMETIC DISPLAYS

MAGAZINE DISPLAYS

SPINDLE DISPLAYS

OTHER DISPLAYS

DISPLAYS

4-SIDED DISPLAYS

SPECIAL ORDER

DESCRIPTION

Metal, masonite and slatwall panels
Fixed and caster models

AVAILABLE DIMENSIONS

WIDTH PANEL (IN)	BASE (IN)	MAXIMUM SHELF DEPTH (IN)	HEIGHT (IN)
24 (4X)	36 x 36	10	54
24 (2X) 30 (2X)	36 x 48	10 16	54
24 (4X)	40 x 40	14	54
24 (4X)	48 x 48	16	54



← Models offered with metal, masonite and slatwall backing, on casters or fixed ↓

















IN THIS SECTION

SHELVES

BRACKETS FOR SHELVES

KICKPLATES AND COVERS

BACKS

SPINDLE PRODUCTS

COMPONENTS

ISLAND ENDS / HALF-ISLANDS

HOOKS

BASKETS

UPRIGHTS

MISCELLANEOUS

ACCESSORIES AND COMPONENTS

SHELVES

SHELF WITH STRAIGHT BRACKETS

INTEGRATED MOULDING FOR 1 1/4 in. HIGH LABEL

SB CODE	ANJOU CODE	MEASURE (IN.)
TMD-01-2410	TDR001024	10 x 24
TMD-01-2412	TDR001224	12 x 24
TMD-01-2414	TDR001424	14 x 24
TMD-01-2416	TDR001624	16 x 24
TMD-01-2418	TDR001824	18 x 24
TMD-01-2420	TDR002024	20 x 24
TMD-01-2422	TDR002224	22 x 24
TMD-01-2424	TDR002424	24 x 24
TMD-01-2426	TDR002624	26 x 24
TMD-01-2428	TDR002824	28 x 24
TMD-01-2430	TDR003024	30 x 24
TMD-01-3010	TDR001030	10 x 30
TMD-01-3012	TDR001230	12 x 30
TMD-01-3014	TDR001430	14 x 30
TMD-01-3016	TDR001630	16 x 30
TMD-01-3018	TDR001830	18 x 30
TMD-01-3020	TDR002030	20 x 30
TMD-01-3022	TDR002230	22 x 30
TMD-01-3024	TDR002430	24 x 30
TMD-01-3026	TDR002630	26 x 30
TMD-01-3028	TDR002830	28 x 30
TMD-01-3030	TDR003030	30 x 30
TMD-01-3610	TDR001036	10 x 36
TMD-01-3612	TDR001236	12 x 36
TMD-01-3614	TDR001436	14 x 36
TMD-01-3616	TDR001636	16 x 36
TMD-01-3618	TDR001836	18 x 36
TMD-01-3620	TDR002036	20 x 36
TMD-01-3622	TDR002236	22 x 36
TMD-01-3624	TDR002436	24 x 36
TMD-01-3626	TDR002636	26 x 36
TMD-01-3628	TDR002836	28 x 36
TMD-01-3630	TDR003036	30 x 36
TMD-01-4810	TDR001048	10 x 48
TMD-01-4812	TDR001248	12 x 48
TMD-01-4814	TDR001448	14 x 48
TMD-01-4816	TDR001648	16 x 48
TMD-01-4818	TDR001848	18 x 48
TMD-01-4820	TDR002048	20 x 48
TMD-01-4822	TDR002248	22 x 48
TMD-01-4824	TDR002448	24 x 48
TMD-01-4826	TDR002648	26 x 48
TMD-01-4828	TDR002848	28 x 48
TMD-01-4830	TDR003048	30 x 48

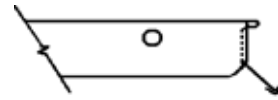
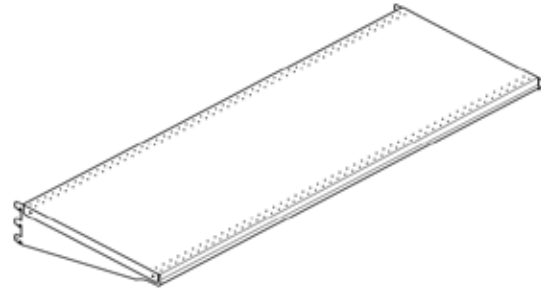

SHELVES

SHELF WITH ADJUSTABLE BRACKETS

INTEGRATED MOULDING FOR 1 1/4 in. HIGH LABEL

SB CODE	ANJOU CODE	MEASURE (IN.)
TMI-01-2406	TIN000624	6 x 24
TMI-01-2408	TIN000824	8 x 24
TMI-01-2410	TIN001024	10 x 24
TMI-01-2412	TIN001224	12 x 24
TMI-01-2414	TIN001424	14 x 24
TMI-01-2416	TIN001624	16 x 24
TMI-01-2418	TIN001824	18 x 24
TMI-01-2420	TIN002024	20 x 24
TMI-01-2422	TIN002224	22 x 24
TMI-01-3006	TIN000630	6 x 30
TMI-01-3008	TIN000830	8 x 30
TMI-01-3010	TIN001030	10 x 30
TMI-01-3012	TIN001230	12 x 30
TMI-01-3014	TIN001430	14 x 30
TMI-01-3016	TIN001630	16 x 30
TMI-01-3018	TIN001830	18 x 30
TMI-01-3020	TIN002030	20 x 30
TMI-01-3022	TIN002230	22 x 30
TMI-01-3606	TIN000636	6 x 36
TMI-01-3608	TIN000836	8 x 36
TMI-01-3610	TIN001036	10 x 36
TMI-01-3612	TIN001236	12 x 36
TMI-01-3614	TIN001436	14 x 36
TMI-01-3616	TIN001636	16 x 36
TMI-01-3618	TIN001836	18 x 36
TMI-01-3620	TIN002036	20 x 36
TMI-01-3622	TIN002236	22 x 36
TMI-01-4806	TIN000648	6 x 48
TMI-01-4808	TIN000848	8 x 48
TMI-01-4810	TIN001048	10 x 48
TMI-01-4812	TIN001248	12 x 48
TMI-01-4814	TIN001448	14 x 48
TMI-01-4816	TIN001648	16 x 48
TMI-01-4818	TIN001848	18 x 48
TMI-01-4820	TIN002048	20 x 48
TMI-01-4822	TIN002248	22 x 48

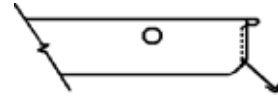
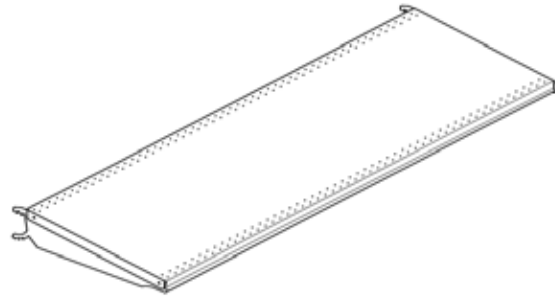

SHELVES

SHELF WITHOUT BRACKETS

INTEGRATED MOULDING FOR 1 1/4 in. HIGH LABEL

SB CODE	ANJOU CODE	MEASURE (IN.)
005-03-2406	003010624	6 x 24
005-03-2408	003010824	8 x 24
005-03-2410	003011024	10 x 24
005-03-2412	003011224	12 x 24
005-03-2414	003011424	14 x 24
005-03-2416	003011624	16 x 24
005-03-2418	003011824	18 x 24
005-03-2420	003012024	20 x 24
005-03-2422	003012224	22 x 24
005-03-2424	003012424	24 x 24
005-03-2426	003012624	26 x 24
005-03-2428	003012824	28 x 24
005-03-2430	003013024	30 x 24
005-03-3006	003010630	6 x 30
005-03-3008	003010830	8 x 30
005-03-3010	003011030	10 x 30
005-03-3012	003011230	12 x 30
005-03-3014	003011430	14 x 30
005-03-3016	003011630	16 x 30
005-03-3018	003011830	18 x 30
005-03-3020	003012030	20 x 30
005-03-3022	003012230	22 x 30
005-03-3024	003012430	24 x 30
005-03-3026	003012630	26 x 30
005-03-3028	003012830	28 x 30
005-03-3030	003013030	30 x 30
005-03-3606	003010636	6 x 36
005-03-3608	003010836	8 x 36
005-03-3610	003011036	10 x 36
005-03-3612	003011236	12 x 36
005-03-3614	003011436	14 x 36
005-03-3616	003011636	16 x 36
005-03-3618	003011836	18 x 36
005-03-3620	003012036	20 x 36
005-03-3622	003012236	22 x 36
005-03-3624	003012436	24 x 36
005-03-3626	003012636	26 x 36
005-03-3628	003012836	28 x 36
005-03-3630	003013036	30 x 36
005-03-4806	003010648	6 x 48
005-03-4808	003010848	8 x 48
005-03-4810	003011048	10 x 48
005-03-4812	003011248	12 x 48
005-03-4814	003011448	14 x 48
005-03-4816	003011648	16 x 48
005-03-4818	003011848	18 x 48
005-03-4820	003012048	20 x 48
005-03-4822	003012248	22 x 48
005-03-4824	003012448	24 x 48
005-03-4826	003012648	26 x 48
005-03-4828	003012848	28 x 48
005-03-4830	003013048	30 x 48

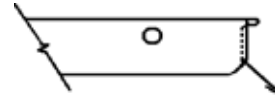
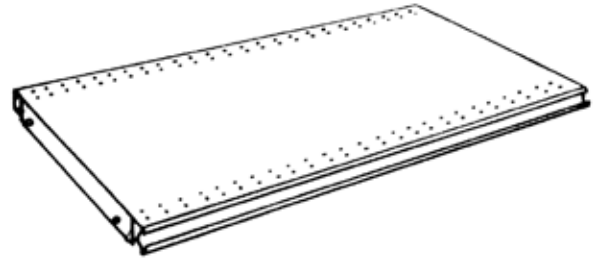

BRACKETS

STRAIGHT BRACKET FOR SHELF

SB CODE	ANJOU CODE	MEASURE (IN.)	
006-00-0010	010010010	10	
006-00-0012	010010012	12	
006-00-0014	010010014	14	
006-00-0016	010010016	16	
006-00-0018	010010018	18	
006-00-0020	010010020	20	
006-00-0022	010010022	22	
006-00-0024	010010024	24	
006-00-0026	010010026	26	
006-00-0028	010010028	28	Sturdy
006-00-0030	010010030	30	Sturdy



ADJUSTABLE BRACKET: 0°, -13°, -26°, -45°

SB CODE	ANJOU CODE	MEASURE (IN.)
006-02-0006	010020006	6
006-02-0008	010020008	8
006-02-0010	010020010	10
006-02-0012	010020012	12
006-02-0014	010020014	14
006-02-0016	010020016	16
006-02-0018	010020018	18



HEAVY DUTY ADJUSTABLE BRACKET

SB CODE	ANJOU CODE	MEASURE (IN.)
006-02-0006	010020016	16
006-02-0008	010020018	18
006-02-0014	010020020	20
006-02-0016	010020022	22
006-02-0018	010020024	24



BRACKETS

STRAIGHT BRACKET FOR WOOD SHELF

SB CODE	ANJOU CODE	MEASURE (IN.)
Left		
006-G4-0006	98006G40006	6
006-G4-0008	98006G40008	8
006-G4-0010	98006G40010	10
006-G4-0012	98006G40012	12
006-G4-0014	98006G40014	14
006-G4-0016	98006G40016	16
006-G4-0018	98006G40018	18
006-G4-0020	98006G40020	20
Right		
006-D4-0006	98006D40006	6
006-D4-0008	98006D40008	8
006-D4-0010	98006D40010	10
006-D4-0012	98006D40012	12
006-D4-0014	98006D40014	14
006-D4-0016	98006D40016	16
006-D4-0018	98006D40018	18
006-D4-0020	98006D40020	20



ADJUSTABLE BRACKET FOR WOOD SHELF

SB CODE	ANJOU CODE	MEASURE (IN.)
Left		
006-G4-0106	98006G40106	6
006-G4-0108	98006G40108	8
006-G4-0110	98006G40110	10
006-G4-0112	98006G40112	12
006-G4-0114	98006G40114	14
006-G4-0116	98006G40116	16
006-G4-0118	98006G40118	18
006-G4-0120	98006G40120	20
Right		
006-D4-0106	98006D40106	6
006-D4-0108	98006D40108	8
006-D4-0110	98006D40110	10
006-D4-0112	98006D40112	12
006-D4-0114	98006D40114	14
006-D4-0116	98006D40116	16
006-D4-0118	98006D40118	18
006-D4-0120	98006D40120	20

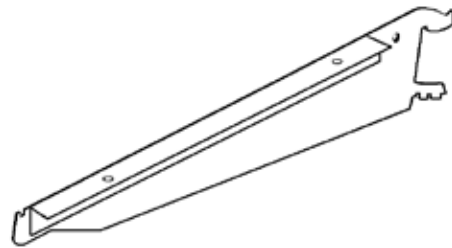

MISCELLANEOUS ACCESSORIES

SELF-ADHESIVE PLASTIC LABEL HOLDER FOR 1 1/4 in. HIGH LABEL

SB CODE	ANJOU CODE	MEASURE (IN.)	
15° ANGLE			
011-11-1524	025092224	24	
011-11-1530	025092230	30	Transparent
011-11-1536	025092236	36	
011-11-1548	025092248	48	
90° ANGLE			
011-11-9024	025092324	24	
011-11-9030	025092330	30	Transparent
011-11-9036	025092336	36	
011-11-9048	025092348	48	
FOR FLAT SURFACE			
011-11-9024		48	Clear backing (34WCL48)
011-11-9030		102	Clear backing

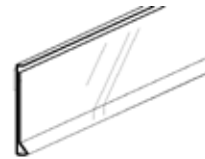
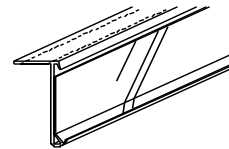
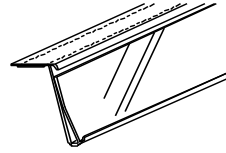

PLASTIC LABEL HOLDER FOR SHELF WITH LABEL MOULDING FOR 1 1/4 in. HIGH LABEL

SB CODE	ANJOU CODE	MEASURE (IN.)	
011-13-2624	025092524	24	Clear backing
011-13-2630	025092530	30	Clear backing
011-13-2636	025092536	36	Clear backing
011-13-2648	025092548	48	Clear backing



PLASTIC LABEL HOLDER FOR WIRE SHELF AND BASKET

SB CODE	ANJOU CODE	MEASURE (IN.)	
45° ANGLE			
011-11-4503	025092603	3	Transparent

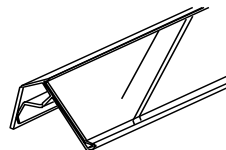

ROLL OF MICA 1 1/4 in. x 500 ft.

SB CODE	
011-11-0001	Clear
011-11-0001B	Blue
011-11-0001R	Red



SELF-ADHESIVE PLASTIC TAB

SB CODE	MEASURE (IN.)	QTY
CLUSTERTAB6116	1 5/8 L x 1 1/4 H	Model 6116 (pack of 20 pcs)

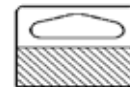

WIRE BASKETS

ENDLESS WIRE MESH BASKET - CHROME FINISH

SB CODE	ANJOU CODE	MEASURE (IN.)
016-03-2412	009031224	12 x 24 L
016-03-2416	009031624	16 x 24 L
016-03-3012	009031230	12 x 30 L
016-03-3014	009031430	14 x 30 L
016-03-3016	009031630	16 x 30 L
016-03-3612	009031236	12 x 36 L
016-03-3614	009031436	14 x 36 L
016-03-3616	009031636	16 x 36 L
016-03-3618	009031836	18 x 36 L
016-03-3620	009032036	20 x 36 L
016-03-3622	009032236	22 x 36 L
016-03-4812	009031248	12 x 48 L
016-03-4814	009031448	14 x 48 L
016-03-4816	009031648	16 x 48 L
016-03-4818	009031848	18 x 48 L
016-03-4820	009032048	20 x 48 L
016-03-4822	009032248	22 x 48 L

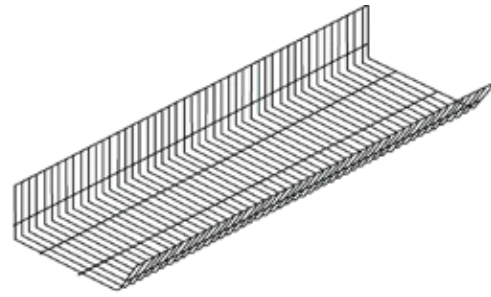

WIRE MESH BASKET DIVIDER - CHROME FINISH

SB CODE	MEASURE (IN.)	MEASURE (IN.) BASKET BOTTOM
016-04-0012	6 x 12 L	9 1/2 L
016-04-0014	6 x 14 L	11 1/2 L
016-04-0016	6 x 16 L	13 1/2 L
016-04-0018	6 x 18 L	15 1/2 L
016-04-0020	6 x 20 L	17 1/2 L
016-04-0022	6 x 22 L	19 1/2 L

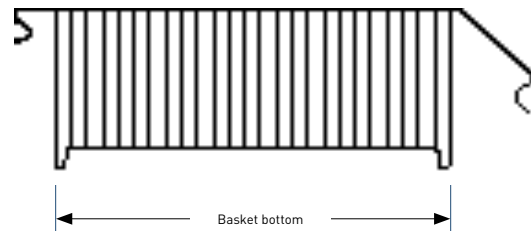

WIRE SHELVES AND DIVIDERS

WIRE DIVIDER, FENCE AND SUBDIVIDER FOR METAL SHELF

SB CODE	ANJOU CODE	MEASURE (IN.)	ACTUAL DIMENSION (IN.)
DIVIDER - CHROME FINISH			
016-02-0012	008020012	2 1/2 H x 12 L	10 1/2 L
016-02-0014	008020014	2 1/2 H x 14 L	12 1/2 L
016-02-0016	008020016	2 1/2 H x 16 L	14 1/2 L
016-02-0018	008020018	2 1/2 H x 18 L	16 1/2 L
016-02-0020	008020020	2 1/2 H x 20 L	18 1/2 L
016-02-0022	008020022	2 1/2 H x 22 L	20 1/2 L
016-02-0124	008020024	2 1/2 H x 24 L	22 1/2 L
FENCE 2 1/2 in. H - CHROME FINISH			
016-02-0024	008010024	2 1/2 H x 24 L	
016-02-0030	008010030	2 1/2 H x 30 L	
016-02-0036	008010036	2 1/2 H x 36 L	
016-02-0048	008010048	2 1/2 H x 48 L	
SUBDIVIDER - CHROME FINISH			
016-02-0004	008030004	2 1/2 H x 4 L	
016-02-0006	008030006	2 1/2 H x 6 L	

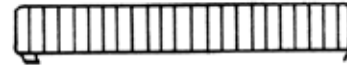

WIRE SHELF WITH 2 1/2 in. EDGE FRONT AND BACK

SB CODE	ANJOU CODE	MEASURE (IN.)	
016-13-4812	98016134812	12 x 48 L	Chrome finish
016-13-4814	98016134814	14 x 48 L	Chrome finish
016-13-4816	98016134816	16 x 48 L	Chrome finish
016-15-4812	98016144812	12 x 48 L	Painted finish
016-15-4814	98016144814	14 x 48 L	Painted finish
016-15-4816	98016144816	16 x 48 L	Painted finish



WIRE SUBDIVIDER FOR WIRE MESH SHELF

SB CODE	MEASURE (IN.)	
016-13-0212	2 1/2 H x 12 L	Chrome finish
016-13-0214	2 1/2 H x 14 L	Chrome finish
016-13-0216	2 1/2 H x 16 L	Chrome finish
016-15-0212	2 1/2 H x 12 L	Painted finish
016-15-0214	2 1/2 H x 14 L	Painted finish
016-15-0216	2 1/2 H x 16 L	Painted finish



BRACKETS FOR WIRE BASKETS AND SHELVES

STRAIGHT BRACKET FOR WIRE BASKET AND SHELF

SB CODE-LEFT	SB CODE-RIGHT	MEASURE (IN.)
006-G5-0010	006-D5-0010	10 (8)
006-G5-0012	006-D5-0012	12 (10)
006-G5-0014	006-D5-0014	14 (12)
006-G5-0016	006-D5-0016	16 (14)
006-G5-0018	006-D5-0018	18 (16)
006-G5-0020	006-D5-0020	20 (18)

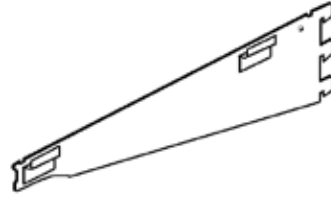

ADJUSTABLE BRACKET FOR WIRE BASKET AND SHELF

SB CODE-LEFT	SB CODE-RIGHT	MEASURE (IN.)
006-G5-0110	006-D5-0110	10
006-G5-0112	006-D5-0112	12
006-G5-0114	006-D5-0114	14
006-G5-0116	006-D5-0116	16

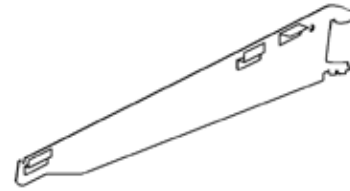

HEAVY DUTY ADJUSTABLE BRACKET FOR WIRE BASKET AND SHELF

SB CODE-LEFT	SB CODE-RIGHT	MEASURE (IN.)
006-G5-0118	006-D5-0118	18
006-G5-0120	006-D5-0120	20
006-G5-0122	006-D5-0122	22
006-G5-0124	006-D5-0124	24



WIRE SHELVES

WIRE SHELF FOR BREAD AND CAKE

SB CODE	ANJOU CODE	MEASURE (IN.)	SPECIAL ORDER
016-01-3620	009022036	20 x 36 L	Chrome finish
016-01-3622	009022236	22 x 36 L	Chrome finish
016-01-4818	009021848	18 x 48 L	Chrome finish
016-01-4820	009022048	20 x 48 L	Chrome finish
016-01-4822	009022248	22 x 48 L	Chrome finish

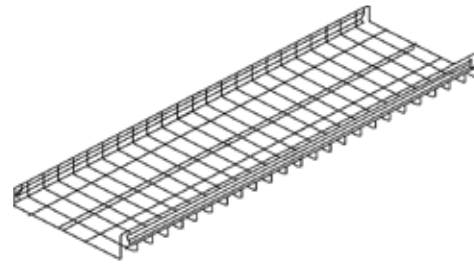

WIRE SHELF WITH 3 in. FRONT EDGE AND BRACKETS

SB CODE	ANJOU CODE	MEASURE (IN.)
090-16-2408	98090160824	8 x 24 L
090-16-2410	98090161024	10 x 24 L
090-16-2412	98090161224	12 x 24 L
090-16-3008	98090160830	8 x 30 L
090-16-3010	98090161030	10 x 30 L
090-16-3012	98090161230	12 x 30 L
090-16-3608	98090160836	8 x 36 L
090-16-3610	98090161036	10 x 36 L
090-16-3612	98090161236	12 x 36 L

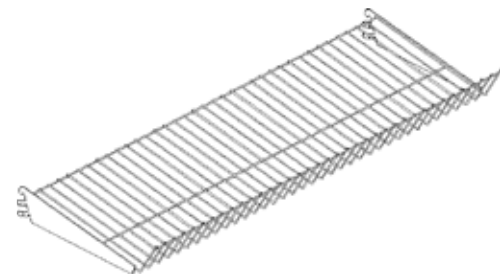

WIRE SHELF WITH 3 in. FRONT EDGE, MOULDING AND BRACKETS

SB CODE	ANJOU CODE	MEASURE (IN.)
090-17-2408	98090170824	8 x 24 L
090-17-2410	98090171024	10 x 24 L
090-17-2412	98090171224	12 x 24 L
090-17-3008	98090170830	8 x 30 L
090-17-3010	98090171030	10 x 30 L
090-17-3012	98090171230	12 x 30 L
090-17-3608	98090170836	8 x 36 L
090-17-3610	98090171036	10 x 36 L
090-17-3612	98090171236	12 x 36 L

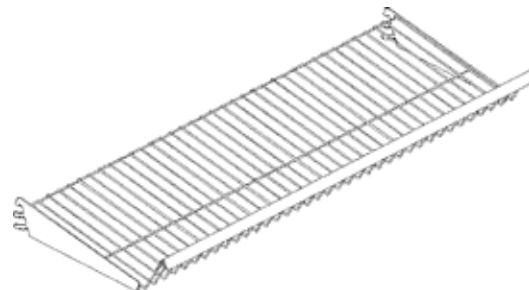

WIRE SHELVES FOR SLATWALL

WIRE SHELF FOR SLATWALL WITH 3 in. FRONT EDGE

SB CODE	ANJOU CODE	MEASURE (IN.)
WITH STRAIGHT BRACKETS FOR SLATWALL		
090-18-2408	98090180824	8 x 24 L
090-18-2410	98090181024	10 x 24L
090-18-2412	98090181224	12 x 24 L
090-18-3008	98090180830	8 x 30 L
090-18-3010	98090181030	10 x 30 L
090-18-3012	98090181230	12 x 30 L
090-18-3608	98090180836	8 x 36 L
090-18-3610	98090181036	10 x 36L
090-18-3612	98090181236	12 x 36 L
WITH SLOPED BRACKETS FOR SLATWALL		
090-19-2408	98090190824	8 x 24 L
090-19-2410	98090191024	10 x 24L
090-19-2412	98090191224	12 x 24 L
090-19-3008	98090190830	8 x 30 L
090-19-3010	98090191030	10 x 30 L
090-19-3012	98090191230	12 x 30 L
090-19-3608	98090190836	8 x 36 L
090-19-3610	98090191036	10 x 36L
090-19-3612	98090191236	12 x 36 L
WITH STRAIGHT BRACKETS AND MOULDING FOR SLATWALL		
090-20-2408	98090200824	8 x 24 L
090-20-2410	98090201024	10 x 24L
090-20-2412	98090201224	12 x 24 L
090-20-3008	98090200830	8 x 30 L
090-20-3010	98090201030	10 x 30 L
090-20-3012	98090201230	12 x 30 L
090-20-3608	98090200836	8 x 36 L
090-20-3610	98090201036	10 x 36L
090-20-3612	98090201236	12 x 36 L
WITH SLOPED BRACKETS AND MOULDING FOR SLATWALL		
090-21-2408	98090210824	8 x 24 L
090-21-2410	98090211024	10 x 24L
090-21-2412	98090211224	12 x 24 L
090-21-3008	98090210830	8 x 30 L
090-21-3010	98090211030	10 x 30 L
090-21-3012	98090211230	12 x 30 L
090-21-3608	98090210836	8 x 36 L
090-21-3610	98090211036	10 x 36L
090-21-3612	98090211236	12 x 36 L

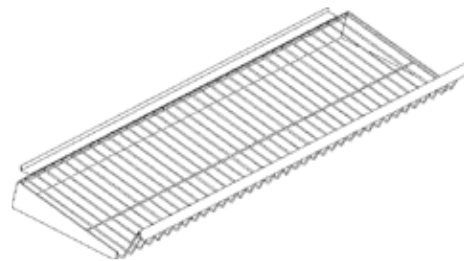

WIRE SHELVES

WIRE SHELF WITH 1 in. FRONT EDGE, MOULDING AND BRACKETS

SB CODE	ANJOU CODE	MEASURE (IN.)
090-22-2404	98090220424	4 x 24 L
090-22-2406	98090220624	6 x 24 L
090-22-2408	98090220824	8 x 24 L
090-22-2410	98090221024	10 x 24 L
090-22-2412	98090221224	12 x 24 L
090-22-3004	98090220430	4 x 30 L
090-22-3006	98090220630	6 x 30 L
090-22-3008	98090220830	8 x 30 L
090-22-3010	98090221030	10 x 30 L
090-22-3012	98090221230	12 x 30 L
090-22-3604	98090220436	4 x 36 L
090-22-3606	98090220636	6 x 36 L
090-22-3608	98090220836	8 x 36 L
090-22-3610	98090221036	10 x 36 L
090-22-3612	98090221236	12 x 36 L

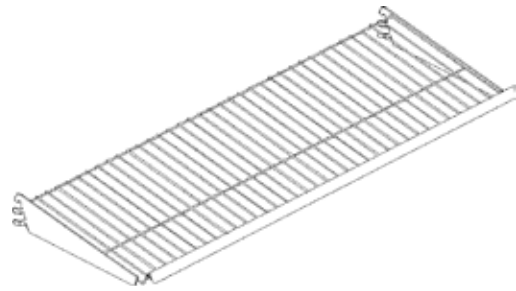

WIRE SHELF WITH BRACKETS AND MOULDING FOR ACRYLIC FENCE

SB CODE	ANJOU CODE	MEASURE (IN.)
090-23-2404	98090230424	4 x 24 L
090-23-2406	98090230624	6 x 24 L
090-23-2408	98090230824	8 x 24 L
090-23-2410	98090231024	10 x 24 L
090-23-2412	98090231224	12 x 24 L
090-23-3004	98090230430	4 x 30 L
090-23-3006	98090230630	6 x 30 L
090-23-3008	98090230830	8 x 30 L
090-23-3010	98090231030	10 x 30 L
090-23-3012	98090231230	12 x 30 L
090-23-3604	98090230436	4 x 36 L
090-23-3606	98090230636	6 x 36 L
090-23-3608	98090230836	8 x 36 L
090-23-3610	98090231036	10 x 36 L
090-23-3612	98090231236	12 x 36 L

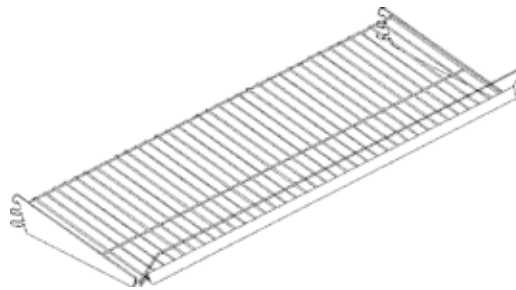

ACRYLIC FENCE FOR WIRE SHELF

SB CODE	ANJOU CODE	MEASURE (IN.)
090-36-2403	98090360324	1/8 x 3 x 24 L
090-36-3003	98090360330	1/8 x 3 x 30 L
090-36-3603	98090360336	1/8 x 3 x 36 L



WIRE BASKETS

33 in. HIGH PROMOTIONAL BASKET WITH SIGN HOLDER

SB CODE	ANJOU CODE	MEASURE (IN.)	
016-08-1414	009071414	14 x 14	Chrome finish
016-08-1814	009071418	14 x 18	Chrome finish
016-08-1818	009071818	18 x 18	Chrome finish
016-08-2424	009072424	24 x 24	Chrome finish

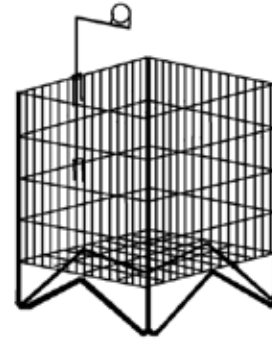

SMALL ENDLESS WIRE BASKET

SB CODE	ANJOU CODE	MEASURE (IN.)	
016-06-0001	009070216	8 x 16 x 5	Chrome finish
016-06-0002	009070416	4 x 6	Divider for small basket

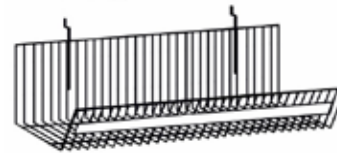

WIRE SHELF WITH METAL BOTTOM

SB CODE	ANJOU CODE	MEASURE (IN.)	
016-27-0001	009070116	7 x 6 x 16	



NEWSPAPER SHELF

SB CODE	ANJOU CODE	MEASURE (IN.)	
090-07-0016	9809070016	13 x 16	For perforated masonite backing
090-07-0116	9809070116	13 x 16	For statwall backing



MISCELLANEOUS ACCESSORIES

ONE-PIECE LITERATURE HOLDER

SB CODE	ANJOU CODE	MEASURE (IN.)	SPECIAL ORDER
017-03-0705	98017030705	5 x 7	
017-03-1108	98017031108	8 1/2 x 11	

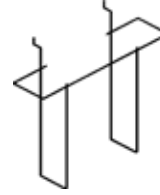

PROFIT STRIP

SB CODE	ANJOU CODE	DESCRIPTION	
016-14-0032	013140132	12 clips, cane type	1
016-14-0131	-	Thin metal with steel label holder plate	2

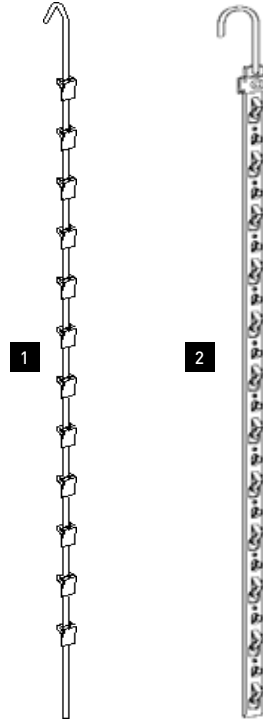

UNIVERSAL CLIP FOR PROFIT STRIP

SB CODE	ANJOU CODE
016-14-0102	013140102

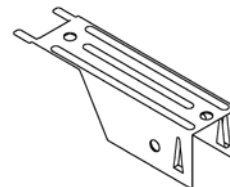

HOOKS

SIMPLE SCAN FLIP HOOK

SB CODE	ANJOU CODE	MEASURE (IN.)
-	0136000104	4
-	0136000106	6
-	0136000108	8
-	0136000111	11



SIMPLE SCAN FLIP HOOK (FOR MASONITE)

SB CODE	ANJOU CODE	MEASURE (IN.)
-	0136200104	4
-	0136200106	6
-	0136200108	8



EXTRA HEAVY BACK PLAT FISH + TIP SCAN

SB CODE	ANJOU CODE	MEASURE (IN.)
016380012-18	013024011	11
016380016-18	013024015	15

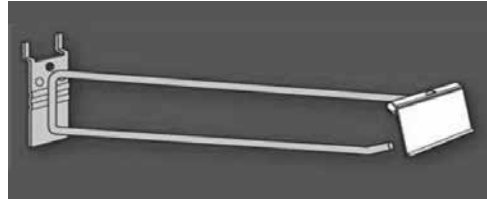

FISH TIP SCAN HOOK (FOR MASONITE)

SB CODE	ANJOU CODE	MEASURE (IN.)
016320004-18	013017004	4
016320006-18	013017006	6
016320008-18	013017008	8
016320011-18	013017011	11

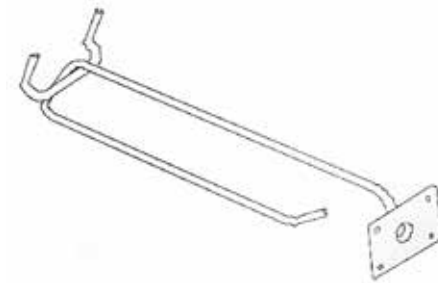

ALL WIRE FISH TIP SCAN LOOP HOOK

SB CODE	ANJOU CODE	MEASURE (IN.)
016330004-18	013018004	4
016330006-18	013018006	6
016330008-18	013018008	8
016330012-18		12

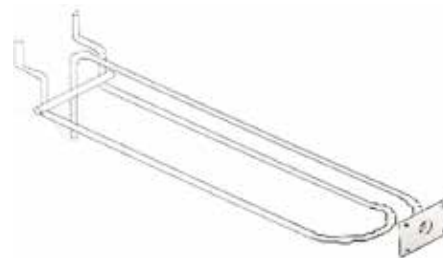

FISH TIP SCAN 2-PIECE (FOR MASONITE)

SB CODE	ANJOU CODE	MEASURE (IN.)
-	013027002	2
016360004-18	013027004	4
016360006-18	013027006	6
016360008-18	013027008	8
016360011-18	013027011	11

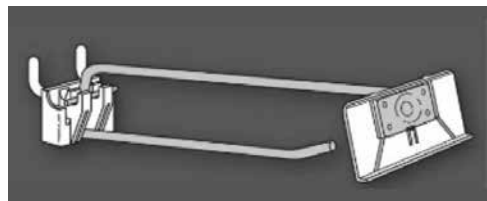

Plastic anchors INCLUDED

HOOKS

FLIP SCAN 2-PIECE HOOK (FOR MASONITE)

SB CODE	ANJOU CODE	MEASURE (IN.)
-	013010404	4
-	013010406	6
-	013010408	8
-	013010411	11

Plastic anchors INCLUDED

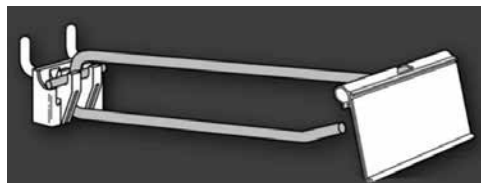

SLATWALL FLIP SCAN HOOK

SB CODE	ANJOU CODE	MEASURE (IN.)	
-	0136003104	4	
-	C13603604*	4	2 in. flip
-	C13603404*	4	3 in. flip
-	0136003106	6	
-	C13603606*	6	2 in. flip
-	C13603406*	6	3 in. flip
-	0136003108	8	
-	C13603608*	8	2 in. flip
-	C13603408*	8	3 in. flip
-	0136003111	11	
-	C13603611*	11	2 in. flip
-	C13603411*	11	3 in. flip

* Includes: hook and plastic flip for price

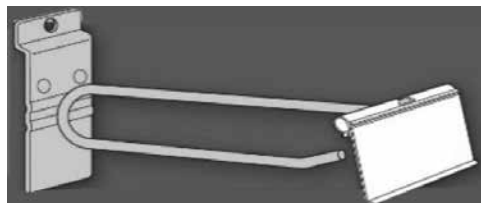

SLATWALL FISH TIP SCAN HOOK

SB CODE	ANJOU CODE	MEASURE (IN.)
016370004-18	013023004	4
016370006-18	013023006	6
016370008-18	013023008	8
016370011-18	013023011	11



SLATWALL FLIP SCAN HOOK

SB CODE	ANJOU CODE	MEASURE (IN.)
-	136003104	4
-	136003106	6
-	136003108	8
-	136003111	11



ALL WIRE SAFETY LOOP HOOK

SB CODE	ANJOU CODE	MEASURE (IN.)
016310004-18	013016004	4
016310006-18	013016006	6
016310008-18	013016008	8

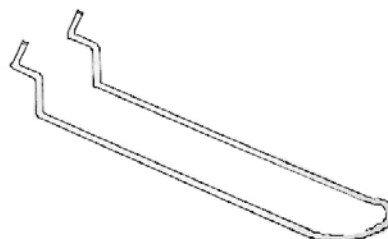

HOOKS

SINGLE HOOK 1-PIECE (FOR MASONITE)

SB CODE	ANJOU CODE	MEASURE (IN.)	
016300002-18	013010002L	2	Light
016300004-18	-	4	
016300006-18	013010006	6	
-	013010008L	8	Light
016300008-18	013010008M	8	Medium
-	013010010M	10	Medium
016300012-18	013010011	12	



ATTACHED BACK SINGLE PRONG

SB CODE	ANJOU CODE	MEASURE (IN.)	
016350004-18	013010204M	4	Medium
016350006-18	013010206M	6	Medium

Rear plastic anchor INCLUDED

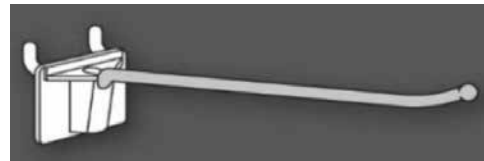

SAFETY LOOP HOOK

SB CODE	ANJOU CODE	MEASURE (IN.)	
016312006-18	013025006	6	

Rear plastic anchor INCLUDED

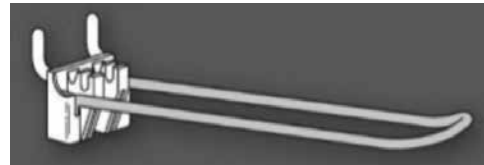

ATTACHED BACK SINGLE PRONG

SB CODE	ANJOU CODE	MEASURE (IN.)	
016350002-18	013021002	2	

Rear plastic anchor INCLUDED

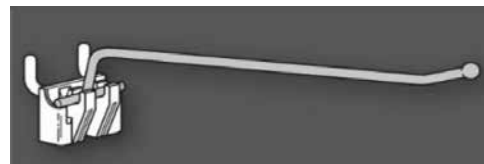

STEELBACK STRAIGHT ENTRY HOOK

SB CODE	ANJOU CODE	MEASURE (IN.)	
-	C13030004	4	For masonite
-	C13610004	4	For metal
-	C13030006	6	For masonite
-	C13031006	6	For metal
-	C13030009	9	For masonite
-	C13031009	9	For metal
-	C13030012	12	For masonite
-	C13031012	12	For metal

Includes anchor plate

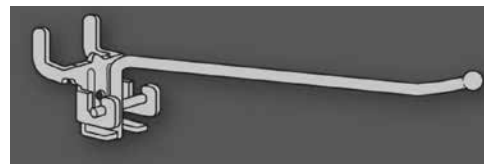

HOOKS

SIMPLE SCAN 3-PIECE HOOK

SB CODE	ANJOU CODE	MEASURE (IN.)	
FOR METAL			
-	C136032.504*	4	2 1/2 in. flip
-	C136032.506*	6	2 1/2 in. flip
-	C136032.508*	8	2 1/2 in. flip
-	C136032.511*	11	2 1/2 in. flip
-	C13603204*	4	2 in. flip
-	C13603206*	6	2 in. flip
-	C13603208*	8	2 in. flip
-	C13603211*	11	2 in. flip
-	C13603304*	4	3 in. flip
-	C13603306*	6	3 in. flip
-	C13603308*	8	3 in. flip
-	C13603311*	11	3 in. flip
-	C13603315*	15	3 in. flip
-	0136004111	11	-
-	0136000115	15	-
FOR MASONITE			
-	C136132.504*	4	2 1/2 in. flip
-	C136132.506*	6	2 1/2 in. flip
-	C136132.508*	8	2 1/2 in. flip
-	C136132.511*	11	2 1/2 in. flip
-	C136132.515*	15	2 1/2 in. flip
-	C13613204*	4	2 in. flip
-	C13613206*	6	2 in. flip
-	C13613208*	8	2 in. flip
-	C13613211*	11	2 in. flip
-	C13613304*	4	3 in. flip
-	C13613306*	6	3 in. flip
-	C13613308*	8	3 in. flip
-	C13613311*	11	3 in. flip
-	0136004111	11	-
-	0136000115	15	-

* Includes: anchor plate, hook and plastic flip for price

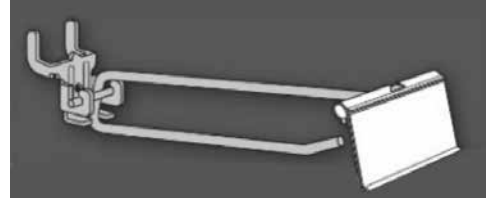

HOOKS

CROSSBAR FLIP SCAN HOOK

SB CODE	ANJOU CODE	MEASURE (IN.)	
-	013029004L	4	Light
-	013028004	4	Medium

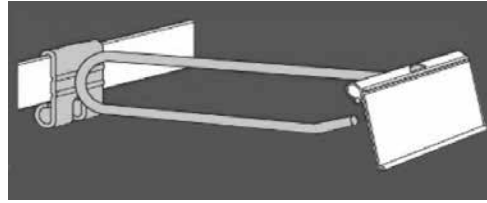

FLIP SCAN HOOK FOR GRID

SB CODE	ANJOU CODE	MEASURE (IN.)	
-	0136002116	6	

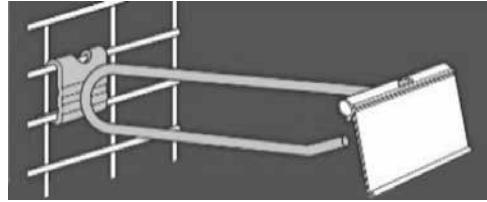

SINGLE PRONG CROSSBAR HOOK

SB CODE	ANJOU CODE	MEASURE (IN.)	
016400004	0136004004	4	



METAL QB FLIP SCAN HOOK

SB CODE	ANJOU CODE	MEASURE (IN.)	
-	013640006	6	



ACCESSORIES FOR SLATWALL

WATERFALL WITH 7 BALLS

SB CODE	QTY	
070-07-0301C	7 balls	Chrome finish



WATERFALL WITH 5 HOOKS

SB CODE	QTY	
070-07-0300C	5 hooks	Chrome finish



FRONTAL

SB CODE	MEASURE (IN.)	
070-07-0302C	1/2 x 1 1/2 x 12 L	Chrome finish



REINFORCED FRONTAL - HEAVY DUTY

SB CODE	MEASURE (IN.)	
060-05-0014	1/2 x 1 1/2 x 14 L	Painted finish
060-05-0016	1/2 x 1 1/2 x 16 L	Painted finish
060-05-0018	1/2 x 1 1/2 x 18 L	Painted finish



MISCELLANEOUS ACCESSORIES

VIDEO SHELF

SB CODE	MEASURE (IN.)
1 3/4 in. D x 5 in. H	
032-10-0024	24 L
032-10-0030	30 L
032-10-0036	36 L
032-10-0048	48 L
3 1/8 in. D x 5 in. H	
032-10-0124	24 L
032-10-0130	30 L
032-10-0136	36 L
032-10-0148	48 L
4 1/8 in. D x 5 in. H	
032-10-0224	24 L
032-10-0230	30 L
032-10-0236	36 L
032-10-0248	48 L

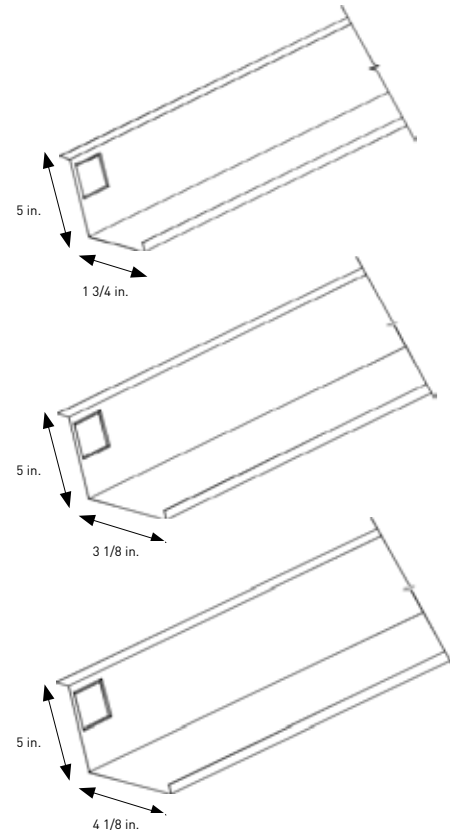

REGULAR VIDEO SHELF BRACKET

SB CODE-LEFT	SB CODE-RIGHT	MEASURE (IN.)
032-17-0001	032-18-0001	1 1/2
032-17-0003	032-18-0003	3
032-17-0005	032-18-0005	5 1/2
032-17-0009	032-18-0009	9

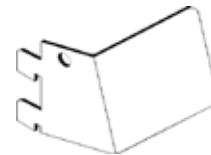

MISCELLANEOUS ACCESSORIES

MAGAZINE RACK

SB CODE	ANJOU CODE	MEASURE (IN.)
3 TIERS OF 9 in. - 12 in. D x 16 in. H		
019-03-0024	012010324	24 L
019-03-0030	012010330	30 L
019-03-0036	012010336	36 L
019-03-0048	012010348	48 L
4 TIERS OF 9 in. - 14 in. D x X 19 in. H		
019-04-0024	012010424	24 L
019-04-0030	012010430	30 L
019-04-0036	012010436	36 L
019-04-0048	012010448	48 L
5 TIERS OF 9 in. - 16 in. D x 22 in. H		
019-05-0024	012010524	24 L
019-05-0030	012010530	30 L
019-05-0036	012010536	36 L
019-05-0048	012010548	48 L

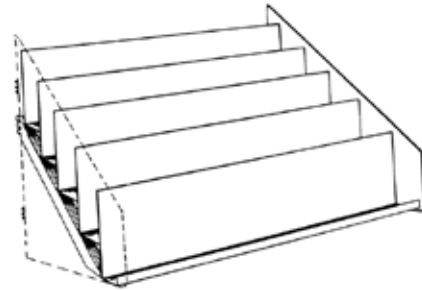
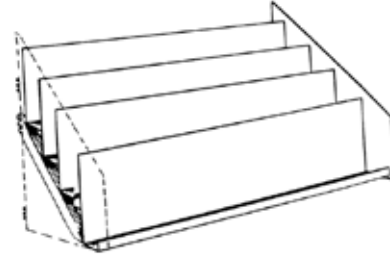
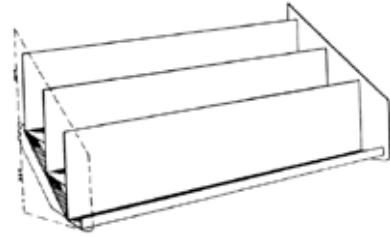

MAGAZINE RACK END PANEL

SB CODE	ANJOU CODE	DESCRIPTION
Left		
019-G3-0002	012012301	For 3-tier rack
019-G4-0002	012012401	For 4-tier rack
019-G5-0002	012012501	For 5-tier rack
Right		
019-D3-0002	012012302	For 3-tier rack
019-D4-0002	012012402	For 4-tier rack
019-D5-0002	012012502	For 5-tier rack

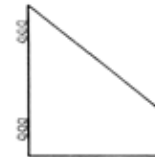

MISCELLANEOUS ACCESSORIES

POCKET BOOK DISPLAY

SB CODE	MEASURE (IN.)
3 TIERS OF 7 in. - 12 in. D x 16 in. H	
018-03-0036	36 L
018-03-0048	48 L
4 TIERS OF 7 in. - 14 in. D x X 19 in. H	
018-04-0036	36 L
018-04-0048	48 L
5 TIERS OF 7 in. - 16 in. D x 22 in. H	
018-05-0036	36 L
018-05-0048	48 L

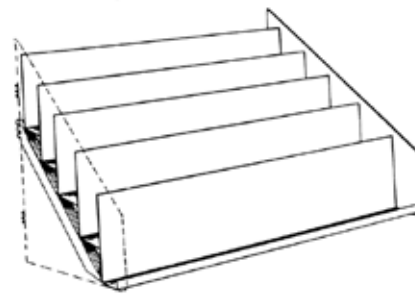
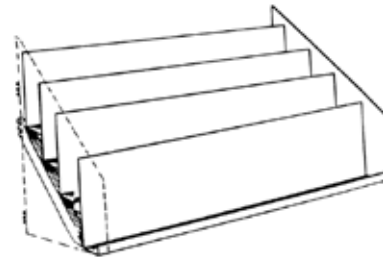
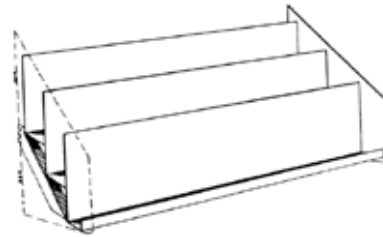

POCKET BOOK DISPLAY END PANEL

SB CODE	ANJOU CODE	DESCRIPTION
Left		
019-G3-0002	-	For 3-tier rack
019-G4-0002	-	For 4-tier rack
019-G5-0002	-	For 5-tier rack
Right		
019-D3-0002	-	For 3-tier rack
019-D4-0002	-	For 4-tier rack
019-D5-0002	-	For 5-tier rack

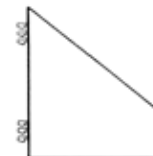

MISCELLANEOUS ACCESSORIES

MAGAZINE WAVE RACK DISPLAY

SB CODE	MEASURE (IN.)	
FOR ISLAND OR WALL - 60 in. H		
PRW-AV-3660	36 L	9-tiers
PRW-AV-4860	48 L	9-tiers
FOR ISLAND OR WALL - 84 in. H		
PRW-AV-3684	36 L	13-tiers
PRW-AV-4884	48 L	13-tiers
COMPONENTS		
019-WAG-005	Left 90° elbow for wall installation	
019-WAD-005	Right 90° elbow for wall installation	

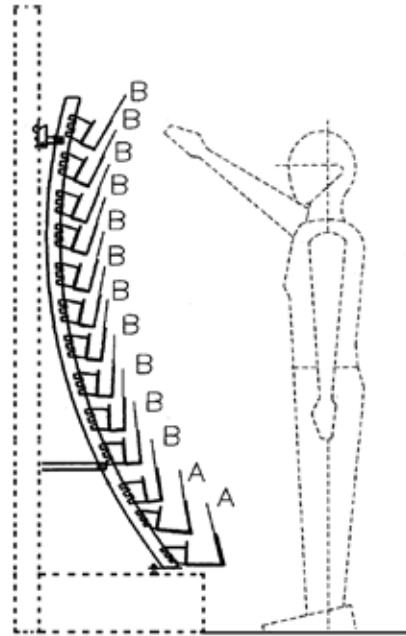

COMPONENTS FOR MAGAZINE WAVE RACK DISPLAY

SB CODE	DESCRIPTION	
ELBOW (left model shown)		
019-WAG-005	Left 90° elbow for wall installation	
019-WAD-005	Right 90° elbow for wall installation	
BRACKET (left model shown)		
019-WAG-004	Left wall bracket	
019-WAD-004	Right wall bracket	
MAGAZINE SHELF		
019-WA-0436	36 L x 3 7/16 H	Lower shelf
019-WA-0448	48 L x 3 7/16 H	Lower shelf
019-WA-0236	36 L x 1 3/4 H	Upper shelf
019-WA-0248	48 L x 1 3/4 H	Upper shelf
1/16 in. CLEAR ACRYLIC FENCE		
019-WA-3608	8 1/2 x 35 15/16	Polished on 3 sides
019-WA-4808	8 1/2 x 47 15/16	Polished on 3 sides

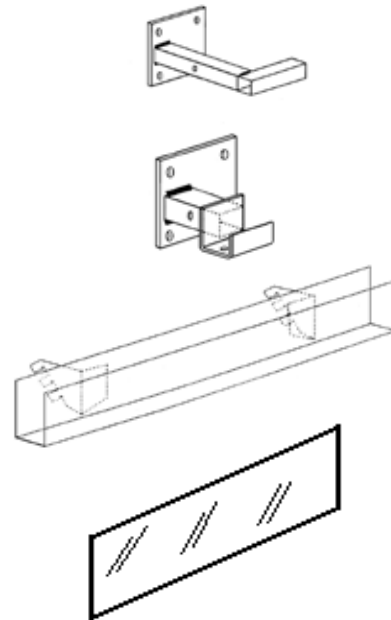

MISCELLANEOUS ACCESSORIES

GREETING CARD DISPLAY

SB CODE	MEASURE (IN.)	
019-09-0036	36 L x 22 3/4 H x 16 D	9-tiers
019-09-0048	48 L x 22 3/4 H x 16 D	9-tiers
019-G9-0002	Left side end panel	
019-D9-0002	Right side end panel	

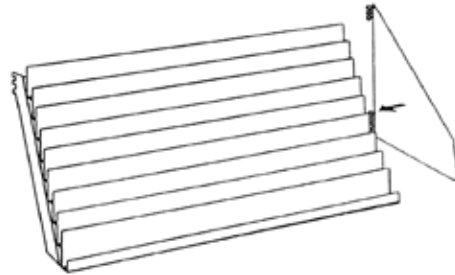

POCKET BOOK SHELF WITH BRACKETS

SB CODE	MEASURE (IN.)
018-06-3606	36 L x 6
018-06-4806	48 L x 6

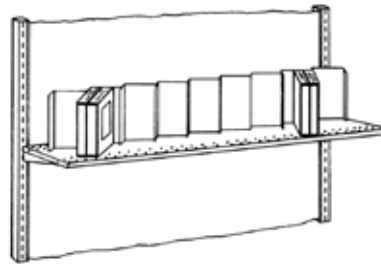

ALBUM SHELF WITH BRACKETS

SB CODE	MEASURE (IN.)
018-07-0048	48 L x 10

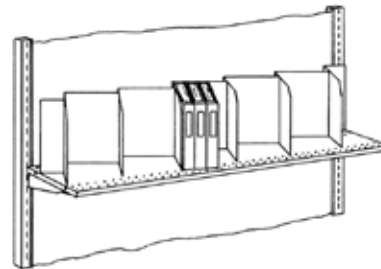

LITERATURE SHELF WITH ADJUSTABLE BRACKETS

SB CODE	MEASURE (IN.)
018-08-0048	48 L x 12

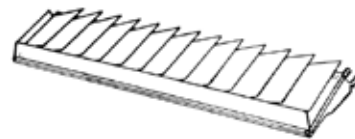

STATIONERY SHELF WITH BRACKETS

SB CODE	MEASURE (IN.)	
018-12-3014	14 x 30	4 in. D with integrated ticket moulding
018-12-3614	14 x 36	4 in. D with integrated ticket moulding
018-12-4814	14 x 48	4 in. D with integrated ticket moulding

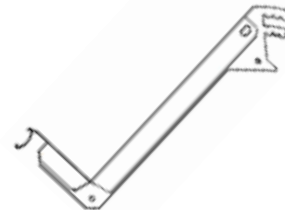

MISCELLANEOUS ACCESSORIES

BOOK SHELF WITH 6 in. HIGH BACK

SB CODE	MEASURE (IN.)
018-11-2406	24 L x 6
018-11-3006	30 L x 6
018-11-3606	36 L x 6
018-11-4806	48 L x 6

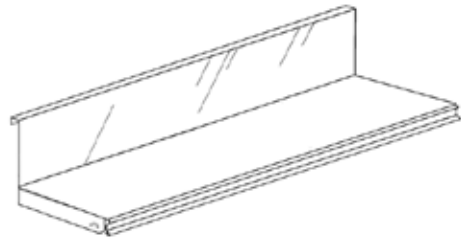

BOOK SHELF BRACKET WITH STOPPER

SB CODE-LEFT	SB CODE -RIGHT	MEASURE (IN.)
006-18-G010	006-18-D010	10
006-18-G012	006-18-D012	12
006-18-G014	006-18-D014	14
006-18-G016	006-18-D016	16

NOTE: If you are using shelves that are more than 6 in. deep, the brackets must be 2 in. longer (ex.: 10 in. shelf = 12 in. brackets)



STEEL DIVIDER

SB CODE	MEASURE (IN.)
M17065364a800_cat	6 H

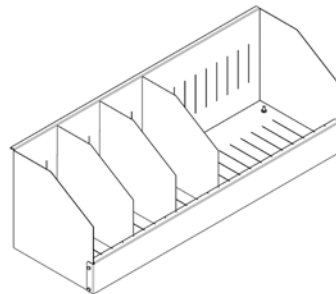

6 in. HIGH STEEL DIVIDER FOR SHELF WITH LABEL MOULDING

SB CODE	MEASURE (IN.)	
028-02-1206G	6 H x 12 L	Left
028-02-1206D	6 H x 12 L	Right



STATIONERY DIVIDER

SB CODE	ANJOU CODE	MEASURE (IN.)
028-02-0010	B028020010	10 x 5
028-02-0012	B028020012	12 x 5

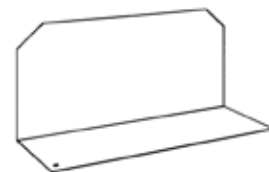

MISCELLANEOUS ACCESSORIES

PLASTIC HAND BASKET AND DISPLAY STAND

SB CODE	ANJOU CODE	DESCRIPTION
043-27-0002B	98043270002B	Blue basket
043-27-0002R	98043270002R	Red basket
043-27-0002V	98043270002V	Green basket
043-27-0000		12 basket capacity display stand

Orange, yellow and turquoise baskets are not available



GABLE END PANEL ATTACHMENT

SB CODE	ANJOU CODE	DESCRIPTION	
039-01-0001	-	Upper attachment - left side	A
039-01-0002	-	Upper attachment - right side	A
035-00-0002	98035000002	Z-shaped lower attachment	B

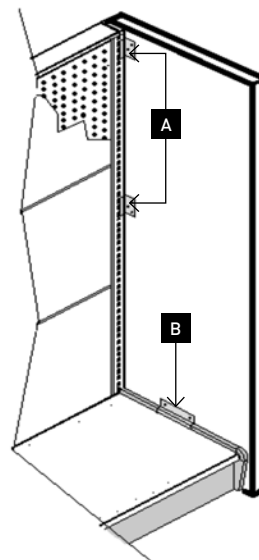
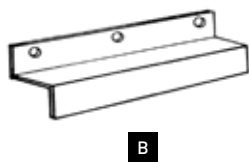
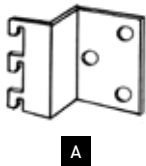

KICKPLATE DRAWER ON CASTERS

SB CODE	ANJOU CODE	MEASURE (IN.)
TIR-01-3012 A700	ZTIR-01-1230	12 x 30 L
TIR-01-3612 A700	ZTIR-01-1236	12 x 36 L
TIR-01-3616 A700	ZTIR-01-1636	16 x 36 L
TIR-01-4812 A700	ZTIR-01-1248	12 x 48 L
TIR-01-4816 A700	ZTIR-01-1648	16 x 48 L

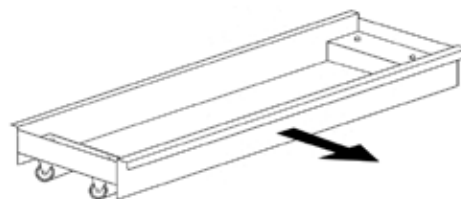

MISCELLANEOUS ACCESSORIES

METAL BASE ON CASTERS

SB CODE	MEASURE (IN.)
M17065364A800	16 x 16 x 48 L

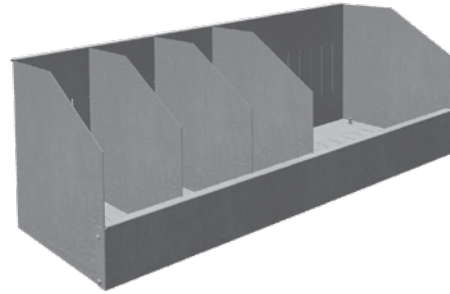

BRACKET FOR LIGHTING DISPLAY OR FASCIA

SB CODE	MEASURE (IN.)	
039-G2-0001	4 H x 1 1/2 L x 2 D	Left
039-D2-0001	4 H x 1 1/2 L x 2 D	Right

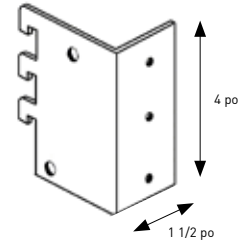

CANOPY EXTENSION BRACKET

SB CODE	ANJOU CODE	MEASURE (IN.)
FOR 1 ELECTRICAL FIXTURE		
006-06-0012	98006060012	12 - adjustable from 12 1/2 to 18 1/5
006-06-0014	98006060014	14 - adjustable from 14 1/2 to 20 1/2
006-06-0016	98006060016	16 - adjustable from 18 1/2 to 22 1/2
006-06-0018	98006060018	18 - adjustable from 18 1/2 to 24 1/2
FOR 2 ELECTRICAL FIXTURES		
006-06-0112	98006060112	12 - adjustable from 12 1/2 to 18 1/5
006-06-0114	98006060114	14 - adjustable from 14 1/2 to 20 1/2
006-06-0116	98006060116	16 - adjustable from 1/2 to 22 1/2
006-06-0118	98006060118	18 - adjustable from 18 1/2 to 24 1/2

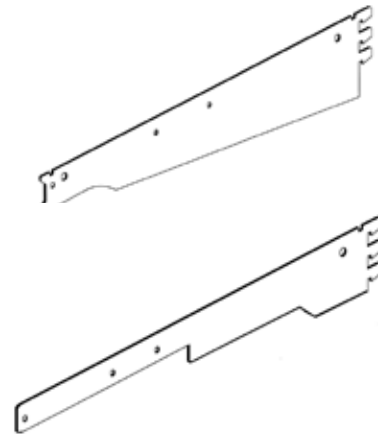

CANOPY EXTENSION

SB CODE	ANJOU CODE	MEASURE (IN.)
FOR 2 ELECTRICAL FIXTURES		
CAN-5G-0009	98CAN5G0009	Left
CAN-5D-0009	98CAN5D0009	Right
CAN-0G-0009	-	Left 10 in. attachment
CAN-0D-0009	-	Right 10 in. attachment

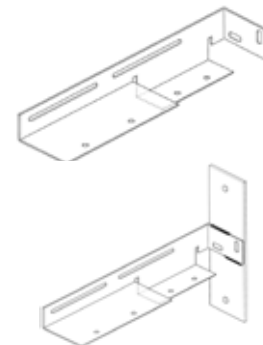

MISCELLANEOUS ACCESSORIES

CARD HOLDER

SB CODE	MEASURE (IN.)
017-01-1108	7 1/4 x 11 adjustable from 12 to 24 H Chrome finish

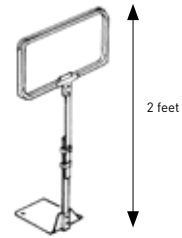

SIGN HOLDER

SB CODE	MEASURE (IN.)
408-00-2217	22 x 17 adjustable from 51 to 77 H
408-00-1711	17 x 11 adjustable from 51 to 77 H

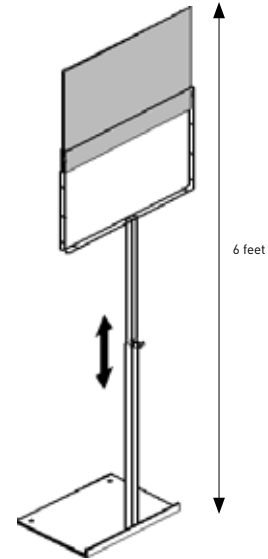

LABELING CART

SB CODE	DESCRIPTION
030-15-0001	Unassembled with 2 shelves
030-15-0000	Assembled with 2 shelves
030-15-0002	Shelf only

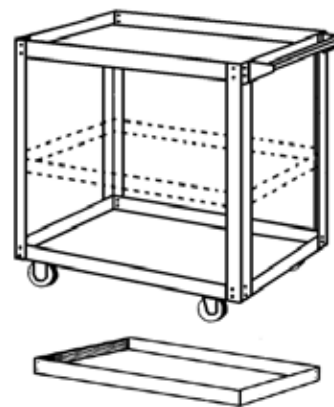

BUGGY WITH CASTERS TO MOVE GONDOLAS

SB CODE	DESCRIPTION
015-01-0000 A700	Buggy
015-01-0001	Pry bar to move gondolas (not illustrated)



MISCELLANEOUS ACCESSORIES

L.E.D. FLUORESCENT LIGHT FIXTURE

SB CODE	MEASURE (IN.)	
SLIM20LED	20 5/8 (4500 K)	22 in. LED fixture
SLIM34LED	32 5/8 (4500 K)	34 in. LED fixture
SLIM46LED	44 5/8 (4500 K)	46 in. LED fixture
INTERCONLED20	20	Interconnection wire
POWERCORDSLIMLED	78 (2 m)	Electrical wire

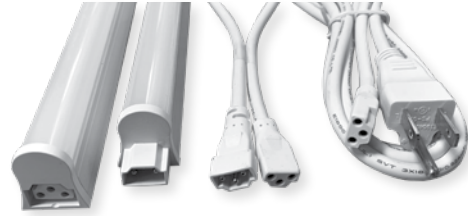

T5 LED LIGHT FIXTURE WITH CLIP

ANJOU CODE	MEASURE (IN.)	
P06046122NM	22 in.	For 24 in. shelf
P06046133NM	33 in.	For 36 in. shelf
P06046145NM	45 in.	For 48 in. shelf
006046F20NM	20	LED connection (female)
006046M78NM	78	LED connection (male)

6 mm GLASS SHELF

SB CODE	ANJOU CODE	MEASURE (IN.)	ACTUAL DIMENSION (IN.)
025-03-3012	003051230	12 x 30 L	12 1/2 x 29 7/8
025-03-3610	003051036	10 x 36 L	10 1/2 x 35 7/8
025-03-3612	003051236	12 x 36 L	12 1/2 x 35 7/8
025-03-3614	003051436	14 x 36 L	14 1/2 x 35 7/8
025-03-3616	003051636	16 x 36 L	16 1/2 x 35 7/8
025-03-3618	003051836	18 x 36 L	18 1/2 x 35 7/8
025-03-4810	003051048	10 x 48 L	10 1/2 x 47 7/8
025-03-4812	003051248	12 x 48 L	12 1/2 x 47 7/8
025-03-4814	003051448	14 x 48 L	14 1/2 x 47 7/8
025-03-4816	003051648	16 x 48 L	16 1/2 x 47 7/8
025-03-4818	003051848	18 x 48 L	18 1/2 x 47 7/8

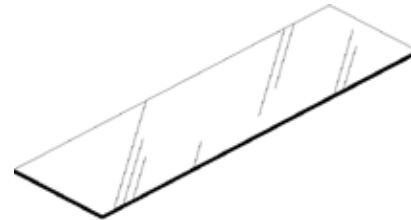

EXTENDED METAL BACK

SPECIAL ORDER

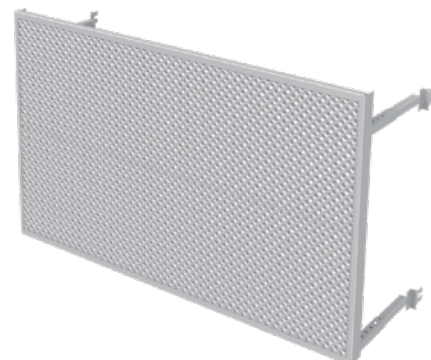

SHELF FRAMES

GLASS SHELF FRAME

SB CODE	MEASURE (IN.)
H-SHAPED	
025-01-2412	12 x 24 L
025-01-3012	12 x 30 L
025-01-3014	14 x 30 L
025-01-3610	10 x 36 L
025-01-3612	12 x 36 L
025-01-3614	14 x 36 L
025-01-3616	16 x 36 L
025-01-3614	18 x 36 L
025-01-4810	10 x 48 L
025-01-4812	12 x 48 L
025-01-4814	14 x 48 L
025-01-4816	16 x 48 L
025-01-4818	18 x 48 L
RECTANGULAR	
025-02-2412	12 x 24 L
025-02-2414	14 x 24 L
025-02-3012	12 x 30 L
025-02-3014	14 x 30 L
025-02-3610	10 x 36 L
025-02-3612	12 x 36 L
025-02-3614	14 x 36 L
025-02-3616	16 x 36 L
025-02-3618	18 x 36 L
025-02-4810	10 x 48 L
025-02-4812	12 x 48 L
025-02-4814	14 x 48 L
025-02-4816	16 x 48 L
025-02-4818	18 x 48 L

Series 006-01-00xx brackets are sold separately

GLASS SHELF FRAME

SLOPED WITH EDGE

SB CODE	MEASURE (IN.)
025-04-2412	12 x 24 L
025-04-3012	12 x 30 L
025-04-3610	10 x 36 L
025-04-3612	12 x 36 L
025-04-3614	14 x 36 L
025-04-4810	10 x 48 L
025-04-4812	12 x 48 L
025-04-4814	14 x 48 L

Brackets included and welded

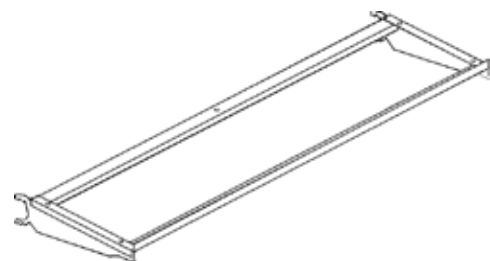
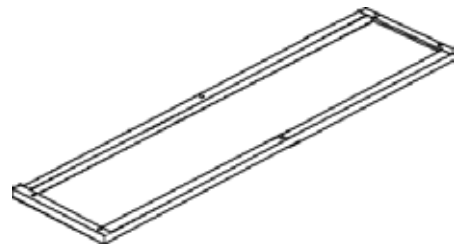
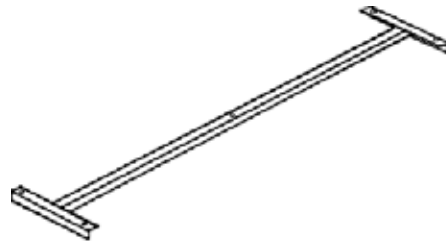

ACCESSORIES FOR SYSTEMS

GLASS SHELVES WITH LED LIGHTING SYSTEM

SPECIAL ORDER



SIGNAGE SYSTEM ON ENGRAVED GLASS WITH LED LIGHTING

DESCRIPTION

SPECIAL ORDER

Strip of LED illuminates edges and engraving on glass panel.



MISCELLANEOUS ACCESSORIES

FLEX WIREMESH BASKET FACADE

DESCRIPTION

The facade makes for flexible sampling, easy to organize and perfectly aligned with identification labels

MEASURE (IN.)

48 L



VERSA-FLEX SHELF

DESCRIPTION

SPECIAL ORDER

The Versa-Flex shelf insures a proper presentation of various products.

The dividers are adjustable at one inch intervals and the shelf is available in various sizes.

The facade makes for flexible sampling, easy to organize and perfectly aligned with identification labels.



DRAPERY / CURTAIN DISPLAYS

DRAPERY DISPLAY

SB CODE	MEASURE (IN.)	SPECIAL ORDER
030-39-0048	48 L	Crossbar with 16 holes
030-39-03814	14 1/8 L	3/8 dia. drapery display rod with a 1 x 2 in. steel plate at the front

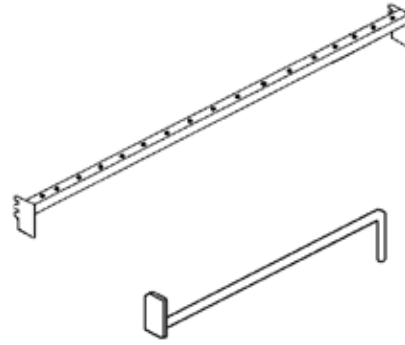

CURTAIN DISPLAY

SB CODE	MEASURE (IN.)	SPECIAL ORDER
09080318A400	1 1/2 x 3 x 18 L	Crossbar with 8 holes
090-80-614B	8 x 14 L	Curtain bracket with 3/8 in. double rod



ACRYLIC FENCE AND ATTACHMENT

ACRYLIC FENCE

SB CODE	ANJOU CODE	MEASURE (IN.)
1/4 X 4 in. H (3 in. EXPOSED)		
043-28-2404	035080424	23 1/2
043-28-3004	035080430	29 1/2
043-28-3604	035080436	35 1/2
043-28-4804	035080448	47 1/2
1/4 X 6 in. H (5 in. EXPOSED)		
043-28-2406	035080624	23 1/2
043-28-3006	035080630	29 1/2
043-28-3606	035080636	35 1/2
043-28-4806	035080648	47 1/2

ATTACHMENT FOR ACRYLIC FENCE FOR SHELF WITH LABEL MOULDING

SB CODE	ANJOU CODE	MEASURE (IN.)
043-28-0024A	035089124A	24 L
043-28-0030A	035089130A	30 L
043-28-0036A	035089136A	36 L
043-28-0048A	035089148A	48 L

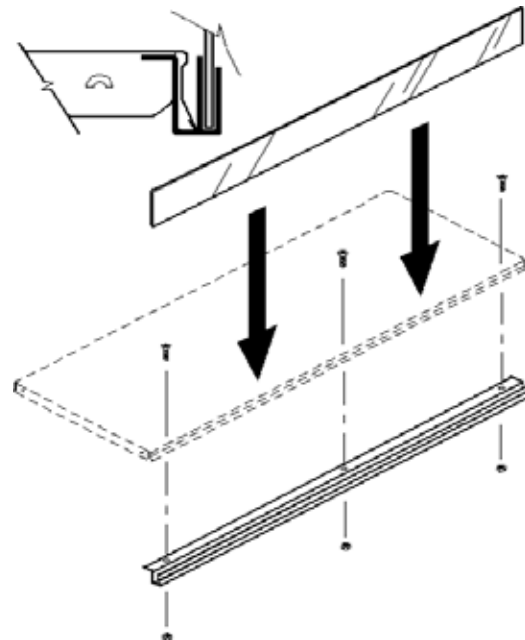

SHELVES

INNOVAFLEX CURVED SHELF

DESCRIPTION

The curvature ratio is always the same, 4 in. more in the middle than the sides. (The dimension in parenthesis represents the depth at mid point)

SB CODE	MEASURE (IN.)	
CONCAVE		
E003-27-1436	14 (18) x 36 L	
E003-27-1636	16 (20) x 36 L	
E003-27-1836	18 (22) x 36 L	Other dimensions available on request
E003-27-1448	14 (18) x 48 L	
E003-27-1648	16 (20) x 48 L	
E003-27-1848	18 (22) x 48 L	
CONVEX		
E003-29-1436	14 (18) x 36 L	
E003-29-1636	16 (20) x 36 L	
E003-29-1836	18 (22) x 36 L	Other dimensions available on request
E003-29-1448	14 (18) x 48 L	
E003-29-1648	16 (20) x 48 L	
E003-29-1848	18 (22) x 48 L	

Also available on request, wedge system to make waves or curves with a structure



CONCAVE



CONVEX

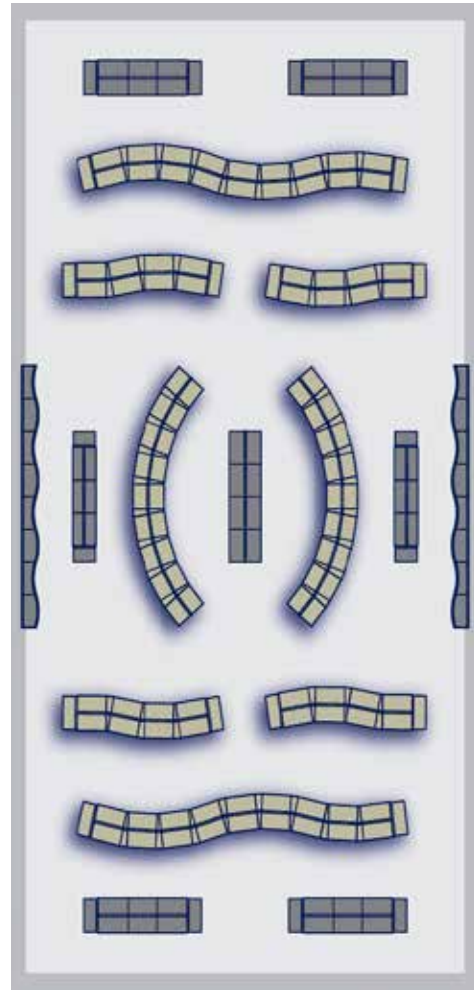

■ CONCAVE
■ CONVEX

KICKPLATE FOR CURVED SHELF

SB CODE	MEASURE (IN.)	
E005-09-1148	48 L	Concave
E005-09-1048	48 L	Convex

MISCELLANEOUS ACCESSORIES

6 in. HIGH DOOR ON HINGE WITH MAGNET TO HIDE TOBACCO PRODUCTS FROM VIEW

SB CODE	ANJOU CODE	MEASURE (IN.)
047-01-2406	017310624	24 L
047-01-3006	017310630	30 L
047-01-3606	017310636	36 L
047-01-4806	-	48 L
047-01-6006	-	60 L

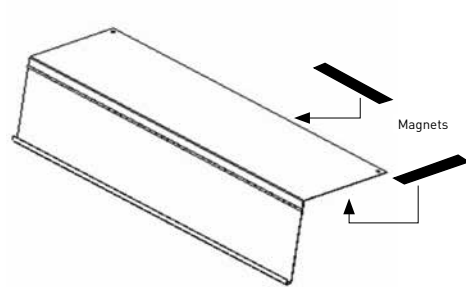

8 in. HIGH DOOR ON HINGE WITH SHELF AND BRACKETS TO HIDE TOBACCO PRODUCTS FROM VIEW

SB CODE	ANJOU CODE	MEASURE (IN.)	
047-02-2410	003241024	10 x 24 L	
047-02-3010	003241030	10 x 30 L	
047-02-3610	003241036	10 x 36 L	
047-02-4810	003241048	10 x 48 L	2 doors
047-02-2412	003241224	12 x 24 L	
047-02-3012	003241230	12 x 30 L	
047-02-3612	003241236	12 x 36 L	
047-02-4812	003241248	12 x 48 L	2 doors

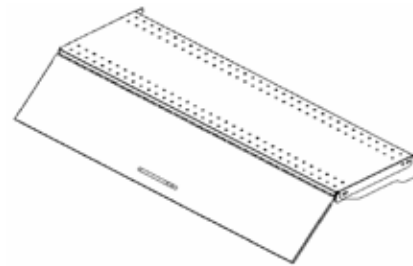

CIGARETTE CABINET

CIGARETTE CABINET - 18 in. DEPTH

SB CODE	MEASURE (IN.)	
014503618293T1R	36 L x 29 H	3 drawers + 1 reserve
014503618295T	36 L x 29 H	5 drawers
014503618344T1R	36 L x 34 H	4 drawers + 1 reserve
014503618346T	36 L x 34 H	6 drawers
014503618395T1R	36 L x 39 H	5 drawers + 1 reserve
014504218395T1R	42 L x 34 H	5 drawers + 1 reserve
014504218295T	42 L x 29 H	5 drawers
014504818295T	42 L x 29 H	5 drawers
014504818293T1R	48 L x 29 H	3 drawers + 1 reserve
014504818395T1R	48 L x 39 H	5 drawers + 1 reserve
01450241854	24 L x 54 H	8 drawers
01450361854	36 L x 54 H	8 drawers
01450481854	48 L x 54 H	8 drawers



MAGNETIC DIVIDER FOR CIGARETTE CABINET

SB CODE	ANJOU CODE	MEASURE (IN.)
E-014-51-0316	014510316	3 3/4 H x 15 7/8 L

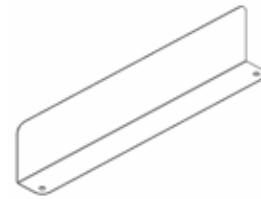

MAGNETIC SUB-DIVIDER FOR CIGARETTE CABINET

SB CODE	ANJOU CODE	MEASURE (IN.)
E-014-51-0303	014510303	3 3/4 H x 3 1/4 L



SLATWALL PANELS

MDF SLATWALL PANEL

MEASURE (IN.)

48 L x 96 H
3/4 in. thickness - 3 in. center on center slotting

AVAILABLE FINISHES:

Natural MDF fiber
Melamine
Laquered
With plastic laminate
With wood laminate

AVAILABLE INSERTIONS:

Plastic laminate
Aluminium
PVC

48 L x 96 H sheets are available upon **SPECIAL ORDER**

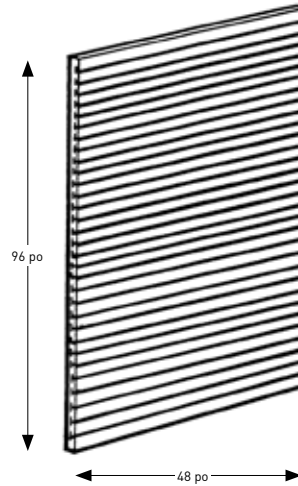

ALUMINIUM SLATWALL PANEL

MEASURE (IN.)

Sold in 6 in. H slats Natural anodized finish

Aluminium slatwall can be inserted into regular structures with the use of adaptors.

Can be painted with a powder coating

A durable and esthetic look in an array of colours **SPECIAL ORDER**



SLATWALL PANEL ACCESSORIES

SHELF BRACKET

SB CODE	MEASURE (IN.)	
070-05-0306C	6 L	Chrome finish
070-05-0308C	8 L	Chrome finish
070-05-0310C	10 L	Chrome finish
070-05-0312C	12 L	Chrome finish
070-05-0314C	14 L	Chrome finish



SLOPED SHELF BRACKET

SB CODE	MEASURE (IN.)	
070-05-03A12C	12 L	Chrome finish



SAMPLE HOOK

SB CODE	MEASURE (IN.)	
070-10-0400C	1 L x 2 3/4 H	Chrome finish



SINGLE HOOK

SB CODE	MEASURE (IN.)	
070-10-0304C	4 L	Chrome finish
070-10-0306C	6 L	Chrome finish
070-10-0308C	8 L	Chrome finish
070-10-0310C	10 L	Chrome finish
070-10-0312C	12 L	Chrome finish



HEAVY DUTY CROSSBAR - 1/2 X 1 1/2 in.

SB CODE	ANJOU CODE	MEASURE (IN.)	
060-07-0024	98060070024	24 L	Painted finish
060-07-0036	98060070036	36 L	Painted finish
060-07-0048	98060070048	48 L	Painted finish



SLATWALL PANEL ACCESSORIES

U-BAR FOR SLATWALL - 1/2 X 1 1/2 in.

SB CODE	MEASURE (IN.)	
060-07-2412	12 x 24 L	Painted finish with chrome top edge
060-07-3612	12 x 36 L	Painted finish with chrome top edge
060-07-4812	12 x 48 L	Painted finish with chrome top edge



WATERFALL WITH BALLS FOR CROSSBAR - 1/2 X 1 1/2 in.

SB CODE	MEASURE (IN.)	
070-07-0500C	7 balls	Painted finish with chrome balls



DRESSING ROOM HOOK

SB CODE	MEASURE (IN.)	
070-10-0600C	3	Chrome finish



ACCESSORIES FOR ETALEX UPRIGHT

CROSSBAR - 1/2 x 1 1/2 in. with 1 1/2 in. spacing

SB CODE	ANJOU CODE	MEASURE (IN.)	
030-00-0130	9803000024	24 L	Painted finish
030-00-0136A	9803000036	36 L	Painted finish
030-00-0148	9803000048	48 L	Painted finish



U-BAR - 1/2 X 1 1/2 in.

CODE	ANJOU CODE	MEASURE (IN.)	
030-00-0148B	For more information, contact your representative	4 x 48 L	Painted finish
030-00-0148D		8 x 48 L	Painted finish
030-00-0148i		10 x 48 L	Painted finish
030-00-0148C		12 x 48 L	Painted finish
030-00-0148G		14 x 48 L	Painted finish
030-00-0148E		16 x 48 L	Painted finish

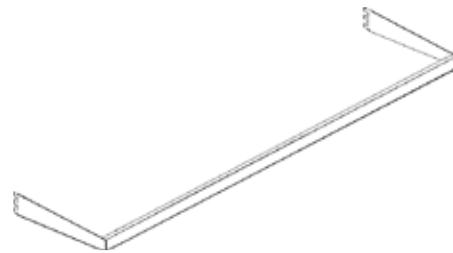

HALF ISLAND - END DISPLAY

END FRAME WITH MASONITE PEGBOARD

SB CODE	MEASURE (IN.)
CBI-00-2441	24 x 41 (48) H
CBI-00-2447	24 x 47 (54) H
CBI-00-2453	24 x 53 (60) H
CBI-00-2459	24 x 59 (66) H
CBI-00-2465	24 x 65 (72) H
CBI-00-2471	24 x 71 (78) H
CBI-00-3041	30 x 41 (48) H
CBI-00-3047	30 x 47 (54) H
CBI-00-3053	30 x 53 (60) H
CBI-00-3059	30 x 59 (66) H
CBI-00-3065	30 x 65 (72) H
CBI-00-3071	30 x 71 (78) H
CBI-00-3641	36 x 41 (48) H
CBI-00-3647	36 x 47 (54) H
CBI-00-3653	36 x 53 (60) H
CBI-00-3659	36 x 59 (66) H
CBI-00-3665	36 x 65 (72) H
CBI-00-3671	36 x 71 (78) H



Illustrated with end frame kickplate sold separately

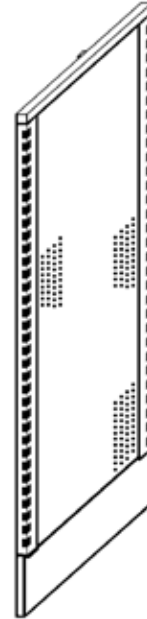

UPPER EXTENSION FOR END FRAME

PERFORATED MASONITE BACKING INCLUDED

SB CODE	MEASURE (IN.)
EBI-00-2406	6 x 24
EBI-00-2412	12 x 24
EBI-00-2418	18 x 24
EBI-00-3006	6 x 30
EBI-00-3012	12 x 30
EBI-00-3018	18 x 30
EBI-00-3606	6 x 36
EBI-00-3612	12 x 36
EBI-00-3618	18 x 36

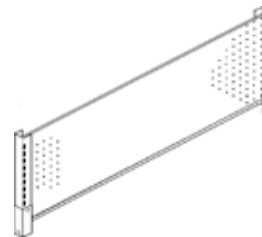

END FRAME KICKPLATE

SB CODE	MEASURE (IN.)	
004-06-0030	9 H x 30 L	Can also be used as a bottom extension
004-06-0036	9 H x 36 L	

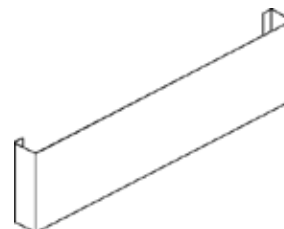

HALF ISLAND - END DISPLAY

END FRAME KICKPLATE

SB CODE	MEASURE (IN.)
PPC-00-3014	For 30 L frame - island with base 14/14
PPC-00-3016	For 30 L frame - island with base 16/16
PPC-00-3018	For 30 L frame - island with base 18/18
PPC-00-3618	For 36 L frame - island with base 18/18

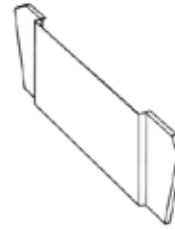

END DISPLAY BASE SHELF WITH KICKPLATE

SB CODE	MEASURE (IN.)
TBI-01-3214	14 x 32 L - island with base 14/14
TBI-01-3218	18 x 32 L - island with base 14/14
TBI-01-3614	14 x 36 L - island with base 16/16
TBI-01-3618	18 x 36 L - island with base 16/16
TBI-01-3624	24 x 36 L - island with base 16/16
TBI-01-4018	18 x 40 L - island with base 18/18

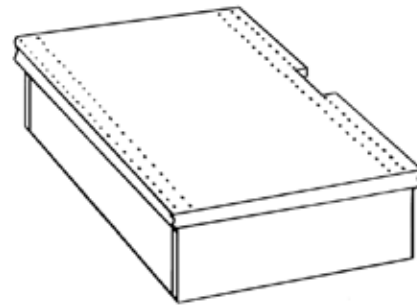

HEAVY DUTY BASE FOR END DISPLAY

SB CODE	MEASURE (IN.)
013-02-3624	24 x 36 L
013-02-4824	24 x 48 L
013-02-5424	24 x 54 L
013-02-6024	24 x 60 L
013-02-6624	24 x 66 L
013-02-7224	24 x 72 L

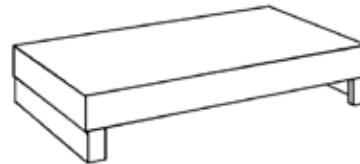

PROMOTIONAL BASE WITH KICKPLATE

SB CODE	MEASURE (IN.)
PRO-04-3020	20 x 30 L
PRO-04-3030	30 x 30 L
PRO-04-3624	24 x 36 L
PRO-04-3636	36 x 36 L
PRO-04-4824	24 x 48 L
PRO-04-4836	36 x 48 L
PRO-04-4848	48 x 48 L

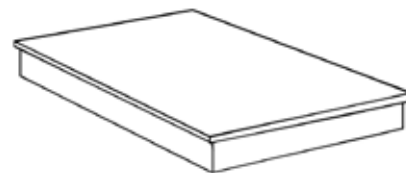

HEAVY DUTY PROMOTIONAL BASE

SB CODE	MEASURE (IN.)	
033-04-3838	38 x 38	Casters not included
033-04-4343	43 x 43	Casters not included
033-04-4848	48 x 48	Casters not included
033-00-0003	4	Single caster swivel type (unit)

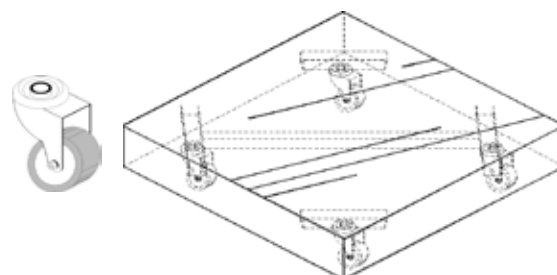

HALF ISLAND - END DISPLAY

PROMOTIONAL SIDE PANEL (WING) WITH PERFORATED MASONITE PANEL (FRONT), PLAIN METAL BACK, UPPER ATTACHMENT FOR DOUBLE UPRIGHT

SB CODE	MEASURE (IN.)
PBD-00-0753	7 x 53 (60) H
PBD-00-0759	7 x 59 (66) H
PBD-00-0765	7 x 65 (72) H
PBD-00-0953	9 x 53 (60) H
PBD-00-0959	9 x 59 (66) H
PBD-00-0965	9 x 65 (72) H
PBD-00-1453	14 x 53 (60) H
PBD-00-1459	14 x 59 (66) H
PBD-00-1465	14 x 65 (72) H
PBD-00-1753	17 x 53 (60) H
PBD-00-1759	17 x 59 (66) H
PBD-00-1765	17 x 65 (72) H
PBD-00-1953	19 x 53 (60) H
PBD-00-1959	19 x 59 (66) H
PBD-00-1965	19 x 65 (72) H

The Z-shaped lower attachment and self-taping Tek screws are included
WARNING: Upper attachment not welded

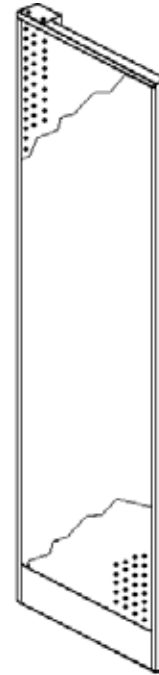

PROMOTIONAL SIDE PANEL (WING) WITH PERFORATED MASONITE PANEL (FRONT), PLAIN METAL BACK, UPPER ATTACHMENT FOR DOUBLE UPRIGHT AND 6 in. DEEP PROTECTIVE WIRES

SB CODE	MEASURE (IN.)
PBP-02-1453	14 x 53 (60) H
PBP-02-1459	14 x 59 (66) H
PBP-02-1465	14 x 65 (72) H
PBP-02-1753	17 x 53 (60) H
PBP-02-1759	17 x 59 (66) H
PBP-02-1765	17 x 65 (72) H
PBP-02-1953	19 x 53 (60) H
PBP-02-1959	19 x 59 (66) H
PBP-02-1965	19 x 65 (72) H

The Z-shaped lower attachment and self-taping Tek screws are included
WARNING: Upper attachment not welded



Wire shelf with plain metal bottom not included

HALF ISLAND - END DISPLAY

PROMOTIONAL SIDE PANEL (WING) WITH PERFORATED METAL PANEL (FRONT), PLAIN METAL BACK, UPPER ATTACHMENT FOR DOUBLE UPRIGHT

SB CODE-LEFT	SB CODE-RIGHT	MEASURE (IN.)
PBM-00-1375	PBM-10-1375	13 x 75 1/2 H
PBM-00-1575	PBM-10-1575	15 x 75 1/2 H
PBM-00-1739	PBM-10-1739	17 x 39 1/2 H
PBM-00-1745	PBM-10-1745	17 x 45 1/2 H
PBM-00-1763	PBM-10-1763	17 x 63 1/2 H
PBM-00-1769	PBM-10-1769	17 x 69 1/2 H
PBM-00-1775	PBM-10-1775	17 x 75 1/2 H
PBM-00-2145	PBM-10-2145	21 x 45 1/2 H
PBM-00-2163	PBM-10-2163	21 x 63 1/2 H
PBM-00-2169	PBM-10-2169	21 x 69 1/2 H
PBM-00-2175	PBM-10-2175	21 x 75 1/2 H
PBM-00-2775	PBM-10-2775	27 x 75 1/2 H
PBM-00-3375	PBM-10-3375	33 x 75 1/2 H

The Z-shaped lower attachment and self-taping Tek screws are included

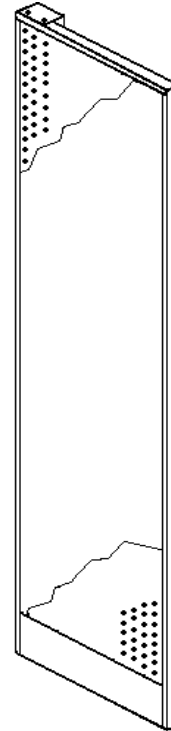

PROMOTIONAL SIDE PANEL (WING) WITH RETURN WITH PERFORATED METAL PANEL (FRONT), PLAIN METAL BACK, UPPER ATTACHMENT FOR DOUBLE UPRIGHT

SB CODE-LEFT	SB CODE-RIGHT	MEASURE (IN.)
PBM-09-1745	PBM-19-1745	9 x 17 x 45 1/2 H
PBM-09-1763	PBM-19-1763	9 x 17 x 63 1/2 H
PBM-09-1769	PBM-19-1769	9 x 17 x 69 1/2 H
PBM-09-1775	PBM-19-1775	9 x 17 x 75 1/2 H
PBM-09-1779	PBM-19-1779	9 x 17 x 79 1/2 H
PBM-09-2175	PBM-19-2175	9 x 21 x 55 1/2 H

The Z-shaped lower attachment and self-taping Tek screws are included

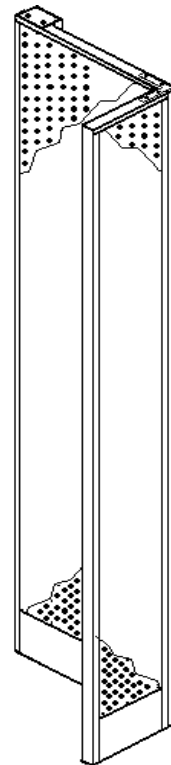

HALF ISLAND - END DISPLAY

PROMOTIONAL WIRE MESH PANEL (WING)

SB CODE	ANJOU CODE	MEASURE (IN.)
016-15-4816	-	16 x 48 - Painted
016-15-4814	98016154814	14 x 48 - Painted
016-13-4814	-	14 x 48 - Chrome
016-13-4816	98016134816	16 x 48 - Chrome
SPB-00-0403	Attachment for promotional wire mesh panel for end display (with double upright only)	
SPB-00-0003	Attachment for promotional wire mesh panel for endframe	

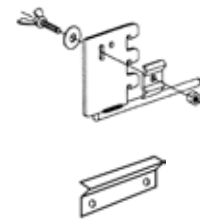

PROMOTIONAL WIRE MESH PANEL BASKET FOR ISLAND END DISPLAY

CODE	MEASURE (IN.)
016-03-0002	13 1/2 L x 3 H

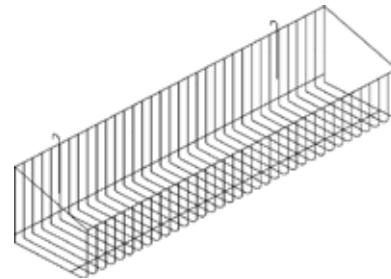

Z-SHAPED BOTTOM ATTACHMENT FOR PROMOTIONAL PANEL

CODE
035-00-0002



COMPONENTS

ETALEX DOUBLE UPRIGHT

SB CODE C SERIES	ANJOU CODE E SERIES	MEASURE (IN.)
END		
001-02-0134	-	34
001-02-0136	001045136	36
001-02-0148	001045148	48
-	001045154	54
001-02-0160	001045160	60
001-02-0166	001045166	66
001-02-0172	001045172	72
001-02-0184	001045184	84
001-02-0190	001045190	90
001-02-0196	001045196	96
CENTER		
001-02-0234	-	34
001-02-0236	001045236	36
001-02-0248	001045248	48
-	001045254	54
001-02-0260	001045260	60
001-02-0266	001045266	66
001-02-0272	001045272	72
001-02-0284	001045284	84
001-02-0290	001045290	90
001-02-0296	001045296	96



DOUBLE UPRIGHT CHANNEL

SB CODE C SERIES	ANJOU CODE E SERIES	MEASURE (IN.)
END		
001-06-0034	001125034	34
001-06-0036	-	36
001-06-0048	001125048	48
001-06-0054	001125054	54
001-06-0060	001125060	60
001-06-0066	001125066	66
001-06-0072	001125072	72
001-06-0084	001125084	84
001-06-0090	001125090	90
001-06-0096	001125096	96

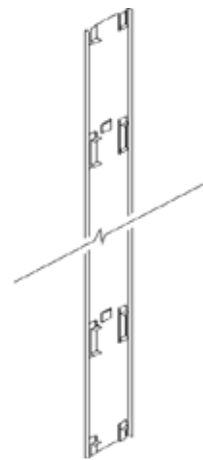

DOUBLE UPRIGHT LEVELER ADAPTOR AND LEVELER

SB CODE	ANJOU CODE	
001-00-0000	-	Leveler with upright leveler adaptor
001-00-0002	530NIVEL3816300	Leveler only 3/8 x 3 in.
700-2-38201	-	3/8 in. square nut

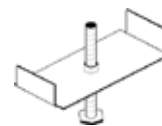

COMPONENTS

SINGLE UPRIGHT FOR ETALEX METAL BACKING

CODE	MEASURE (IN.)
LEFT END - 1 1/2 D	
001010336	36
001010348	48
001010354	54
001010360	60
001010366	66
001010372	72
001010384	84
001010390	90
001010396	96
RIGHT END - 1 1/2 D	
001010136	36
001010148	48
001010154	54
001010160	60
001010166	66
001010172	72
001010184	84
001010190	90
001010196	96
CENTER END - 1 1/2 D	
001010236	36
001010248	48
001010254	54
001010260	60
001010266	66
001010272	72
001010284	84
001010290	90
001010296	96

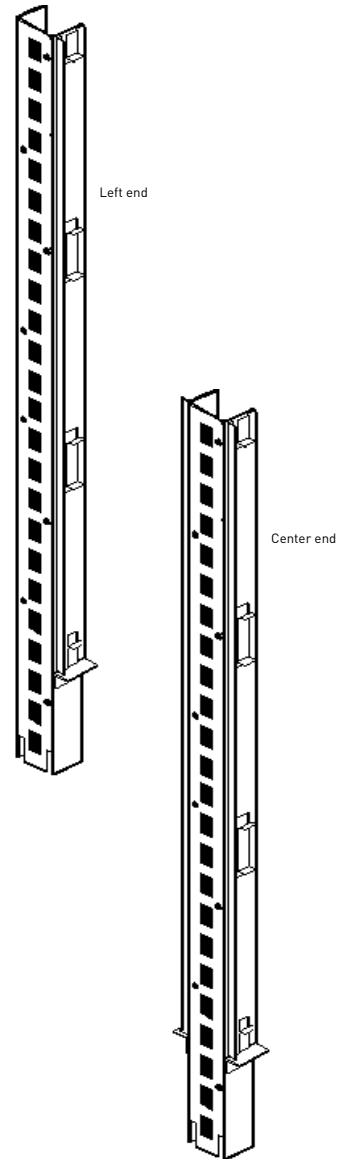

SINGLE UPRIGHT - 1 in. D x 1 3/8 in. L

SB CODE	ANJOU CODE	MEASURE (IN.)
001-01-0036	001011036	36
001-01-0048	001011048	48
001-01-0054	001011054	54
001-01-0060	001011060	60
001-01-0066	001011006	66
001-01-0072	001011072	72
001-01-0084	001011084	84
001-01-0090	001011090	90
001-01-0096	001011096	96

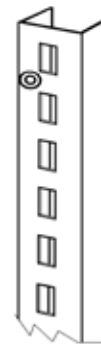

COMPONENTS

SINGLE UPRIGHT FOR SERIES B SLATWALL BACKING FULL LENGTH CHANNEL

SB CODE	MEASURE (IN.)
LEFT END - 1 3/8 in. L - 1 in. D	
B001-10-G136	36
B001-10-G148	48
B001-10-G154	54
B001-10-G160	60
B001-10-G166	66
B001-10-G172	72
B001-10-G184	84
B001-10-G190	90
B001-10-G196	96
RIGHT END - 1 3/8 in. L - 1 in. D	
B001-10-D136	36
B001-10-D148	48
B001-10-D154	54
B001-10-D160	60
B001-10-D166	66
B001-10-D172	72
B001-10-D184	84
B001-10-D190	90
B001-10-D196	96
CENTER END - 1 3/8 in. L - 1 in. D	
B001-10-0236	36
B001-10-0248	48
B001-10-0254	54
B001-10-0260	60
B001-10-0266	66
B001-10-0272	72
B001-10-0284	84
B001-10-0290	90
B001-10-0296	96

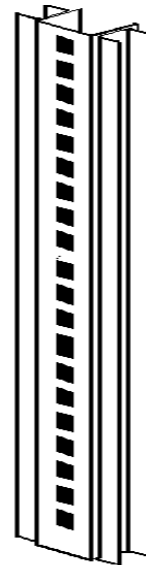

COMPONENTS

SINGLE UPRIGHT FOR ETALEX SLATWALL BACKING

CODE	MEASURE (IN.)
LEFT END - 1 1/2 in. D	
001012048G	48
001012054G	54
001012066G	66
001012072G	72
001012084G	84
001012096G	96
RIGHT END - 1 1/2 in. D	
001012048D	48
001012054D	54
001012066D	66
001012072D	72
001012084D	84
001012096D	96
CENTER END - 1 1/2 in. D	
001012048C	48
001012054C	54
001012066C	66
001012072C	72
001012084C	84
001012096C	96

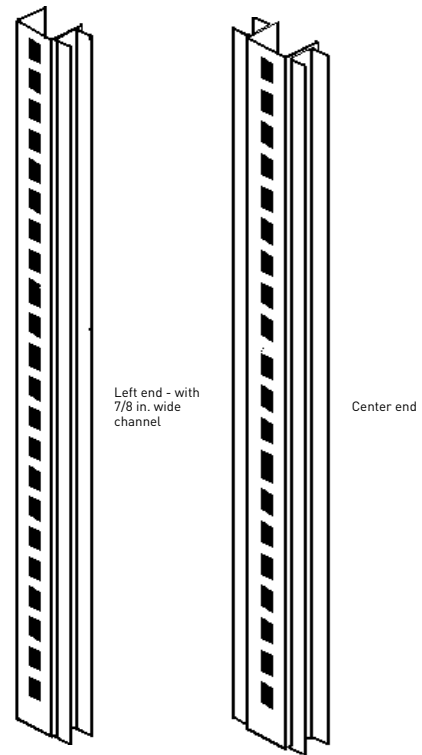

COMPONENTS

E SERIES EXTENSION FOR DOUBLE UPRIGHT

ANJOU CODE	MEASURE (IN.)	
END: 1 1/4 in. L X 3 in. D		
001135106N	6	Masonite backing
001135112N	12	Masonite backing
001135107N	7 1/4	Metal backing
001135114N	14 1/4	Metal backing
001135121N	21 3/4	Metal backing
001135129N	29	Metal backing
CENTER: 1 1/4 in. L X 3 in. D		
001135206N	6	Masonite backing
001135212N	12	Masonite backing
001135207N	7 1/4	Metal backing
001135214N	14 1/4	Metal backing
001135221N	21 3/4	Metal backing
001135229N	29	Metal backing



C SERIES EXTENSION FOR DOUBLE UPRIGHT

SB CODE	MEASURE (IN.)	
END		
001-03-0106	6	Masonite backing
001-03-0107	7 1/4	Metal backing
001-03-0112	12	Masonite backing
001-03-0114	14 1/4	Metal backing
001-03-0118	18	Masonite backing
001-03-0124	24	Masonite backing
001-03-0129	29	Metal backing
001-03-0130	30	Masonite backing
CENTER		
001-03-0206	6	Masonite backing
001-03-0207	7 1/4	Metal backing
001-03-0212	12	Masonite backing
001-03-0214	14 1/4	Metal backing
001-03-0218	18	Masonite backing
001-03-0224	24	Masonite backing
001-03-0229	29	Metal backing
001-03-0230	30	Masonite backing

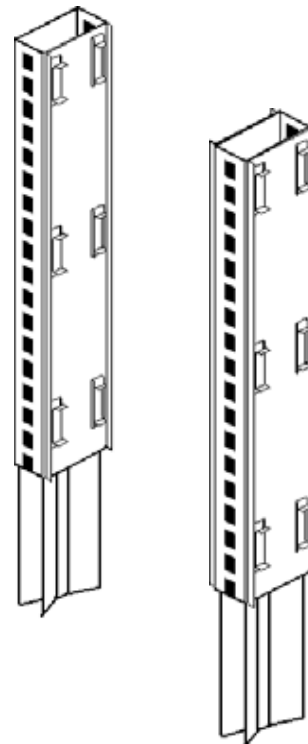

COMPONENTS

FOOT COVER - WITH LEVELER

SB CODE C SERIES	ANJOU CODE E SERIES	MEASURE (IN.)
002-01-0008	004080008	8
002-01-0010	004080010	10
002-01-0012	004080012	12
002-01-0014	004080014	14
002-01-0016	004080016	16
002-01-0018	004080018	18
002-01-0020	004080020	20
002-01-0022	004080022	22
002-01-0024	004080024	24
002-01-0026	004080026	26
002-01-0028	004080028	28
002-01-0030	004080030	30
002-01-0036	004080036	36

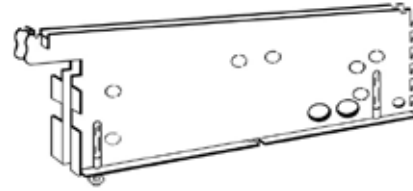

FOOT EXTENSION COVER

SB CODE C SERIES	ANJOU CODE E SERIES	MEASURE (IN.)
002-02-0004	004060004	4
002-02-0006	004060006	6
002-02-0008	004060008	8
002-02-0010	004060010	10
002-02-0012	004060012	12

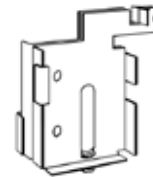

COMPONENTS

FOOT COVER

SB CODE C SERIES	ANJOU CODE E SERIES	MEASURE (IN.)
LEFT		
003-0G-0008	004010008G	8
003-0G-0010	004010010G	10
003-0G-0012	004010012G	12
003-0G-0014	004010014G	14
003-0G-0016	004010016G	16
003-0G-0018	004010018G	18
003-0G-0020	004010020G	20
003-0G-0022	004010022G	22
003-0G-0024	004010024G	24
003-0G-0026	004010026G	26
003-0G-0028	004010028G	28
003-0G-0030	004010030G	30
003-0G-0036	004010036G	36
RIGHT		
003-0D-0008	004010008D	8
003-0D-0010	004010010D	10
003-0D-0012	004010012D	12
003-0D-0014	004010014D	14
003-0D-0016	004010016D	16
003-0D-0018	004010018D	18
003-0D-0020	004010020D	20
003-0D-0022	004010022D	22
003-0D-0024	004010024D	24
003-0D-0026	004010026D	26
003-0D-0028	004010028D	28
003-0D-0030	004010030D	30
003-0D-0036	004010036D	36

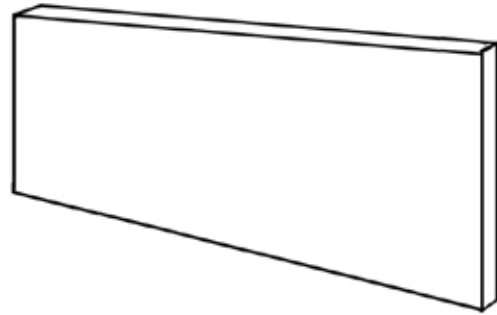

FOOT EXTENSION COVER

SB CODE C SERIES	MEASURE (IN.)
LEFT	
003-01-0104	4
003-01-0106	6
003-01-0108	8
003-01-0110	10
003-01-0112	12
RIGHT	
003-01-0204	4
003-01-0206	6
003-01-0208	8
003-01-0210	10
003-01-0212	12

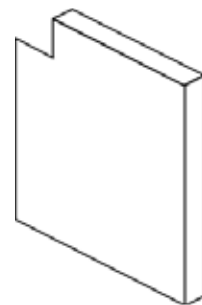

COMPONENTS

C SERIES PLAIN MASONITE BACKING FOR STRUCTURE

SB CODE	MEASURE (IN.)
007-01-2429	22 1/2 x 28 7/8
007-01-2443	22 1/2 x 43 3/8
007-01-2450	22 1/2 x 50 5/8
007-01-3022	28 1/2 x 21 5/8
007-01-3029	28 1/2 x 28 7/8
007-01-3043	28 1/2 x 43 3/8
007-01-3050	28 1/2 x 50 5/8
007-01-3622	34 1/2 x 21 5/8
007-01-3629	34 1/2 x 28 7/8
007-01-3643	34 1/2 x 43 3/8
007-01-3650	34 1/2 x 50 5/8
007-01-4822	46 1/2 x 21 5/8
007-01-4829	46 1/2 x 28 7/8
007-01-4843	46 1/2 x 43 3/8
007-01-4850	46 1/2 x 50 5/8

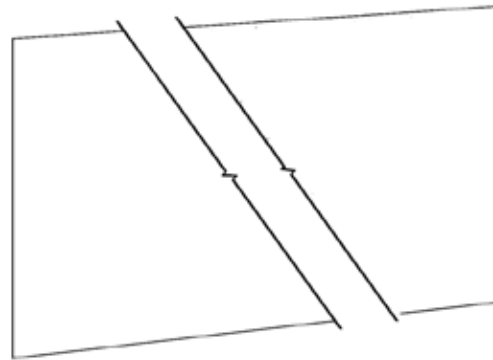

C SERIES PLAIN MASONITE BACKING FOR EXTENSION

SB CODE	MEASURE (IN.)
007-01-2406	22 1/2 x 6
007-01-2412	22 1/2 x 12
007-01-2418	22 1/2 x 18
007-01-2424	22 1/2 x 24
007-01-3006	28 1/2 x 6
007-01-3012	28 1/2 x 12
007-01-3006	28 1/2 x 18
007-01-3024	28 1/2 x 24
007-01-3606	34 1/2 x 6
007-01-3612	34 1/2 x 12
007-01-3618	34 1/2 x 18
007-01-3624	34 1/2 x 24
007-01-4806	46 1/2 x 6
007-01-4812	46 1/2 x 12
007-01-4818	46 1/2 x 18
007-01-4824	46 1/2 x 24

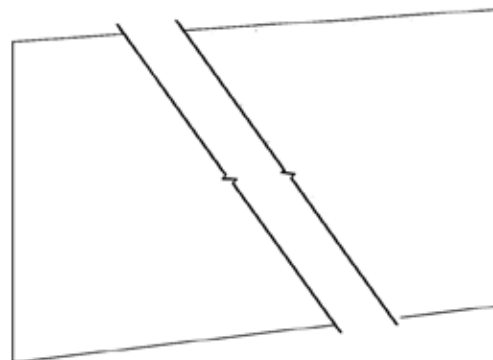

COMPONENTS

C SERIES PERFORATED MASONITE BACKING FOR STRUCTURE

SB CODE	MEASURE (IN.)
007-02-2422	22 1/2 x 21 5/8
007-02-2429	22 1/2 x 28 7/8
007-02-2443	22 1/2 x 43 3/8
007-02-2450	22 1/2 x 50 5/8
007-02-3022	28 1/2 x 21 5/8
007-02-3029	28 1/2 x 28 7/8
007-02-3043	28 1/2 x 43 3/8
007-02-3050	28 1/2 x 50 5/8
007-02-3622	34 1/2 x 21 5/8
007-02-3629	34 1/2 x 28 7/8
007-02-3643	34 1/2 x 43 3/8
007-02-3650	34 1/2 x 50 5/8
007-02-4822	46 1/2 x 21 5/8
007-02-4829	46 1/2 x 28 7/8
007-02-4843	46 1/2 x 43 3/8
007-02-4850	46 1/2 x 50 5/8

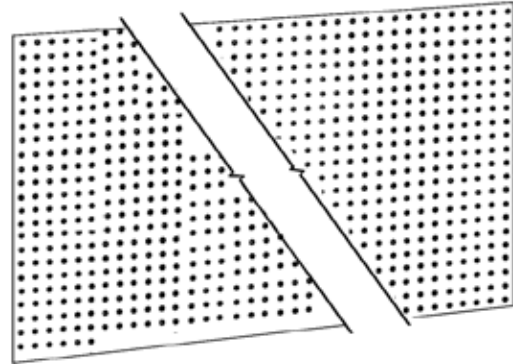

C SERIES PERFORATED MASONITE BACKING FOR EXTENSION

SB CODE	MEASURE (IN.)
007-02-2406	22 1/2 x 6
007-02-2412	22 1/2 x 12
007-02-2418	22 1/2 x 18
007-02-2424	22 1/2 x 24
007-02-3006	28 1/2 x 6
007-02-3012	28 1/2 x 12
007-02-3006	28 1/2 x 18
007-02-3024	28 1/2 x 24
007-02-3606	34 1/2 x 6
007-02-3612	34 1/2 x 12
007-02-3618	34 1/2 x 18
007-02-3624	34 1/2 x 24
007-02-4806	46 1/2 x 6
007-02-4812	46 1/2 x 12
007-02-4818	46 1/2 x 18
007-02-4824	46 1/2 x 24

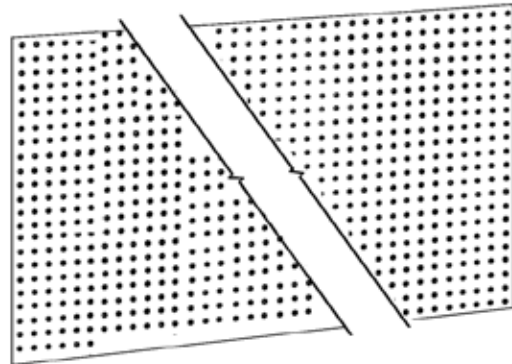

COMPONENTS

S SERIES PLAIN MASONITE BACKING

ANJOU CODE	MEASURE (IN.)
WIDTH: 24 in.	
024052410	22 9/16 x 10
02405241718	22 9/16 x 17 1/8
02405242412	22 9/16 x 24 1/2
02405243158	22 9/16 x 31 5/8
02405243878	22 9/16 x 38 7/8
024052436516	22 9/16 x 36 5/16
02405244358	22 9/16 x 43 5/8
02405244618	22 9/16 x 46 1/8
024052448	22 9/16 x 48
0240524501316	22 9/16 x 50 13/16
WIDTH: 30 in.	
024053010	28 9/16 x 10
02405301718	28 9/16 x 17 1/8
02405302412	28 9/16 x 24 1/2
02405303158	28 9/16 x 31 5/8
02405303878	28 9/16 x 38 7/8
024053036516	28 9/16 x 36 5/16
02405304358	28 9/16 x 43 5/8
02405304618	28 9/16 x 46 1/8
024053048	28 9/16 x 48
0240530501316	28 9/16 x 50 13/16
WIDTH: 36 in.	
024053610	34 9/16 x 10
02405361718	34 9/16 x 17 1/8
02405362412	34 9/16 x 24 1/2
02405363158	34 9/16 x 31 5/8
02405363878	34 9/16 x 38 7/8
024053636516	34 9/16 x 36 5/16
02405364358	34 9/16 x 43 5/8
02405364618	34 9/16 x 46 1/8
024053648	34 9/16 x 48
0240536501316	34 9/16 x 50 13/16
WIDTH: 48 in.	
024054810	46 9/16 x 10
02405481718	46 9/16 x 17 1/8
02405482412	46 9/16 x 24 1/2
02405483158	46 9/16 x 31 5/8
02405483878	46 9/16 x 38 7/8
024054836516	46 9/16 x 36 5/16
02405484358	46 9/16 x 43 5/8
02405484618	46 9/16 x 46 1/8
024054848	46 9/16 x 48
0240548501316	46 9/16 x 50 13/16

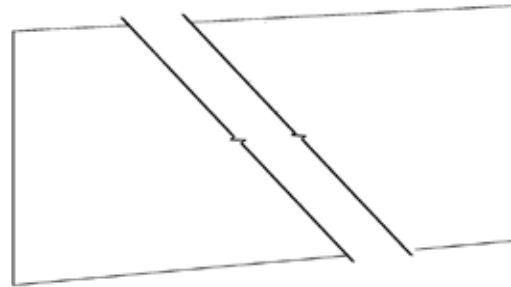

COMPONENTS

S SERIES PERFORATED MASONITE BACKING

ANJOU CODE	MEASURE (IN.)
WIDTH: 24 in.	
024062410	22 9/16 x 10
02406241718	22 9/16 x 17 1/8
02406242412	22 9/16 x 24 1/2
02406243158	22 9/16 x 31 5/8
02406243878	22 9/16 x 38 7/8
024062436516	22 9/16 x 36 5/16
02406244358	22 9/16 x 43 5/8
02406244618	22 9/16 x 46 1/8
024062448	22 9/16 x 48
0240624501316	22 9/16 x 50 13/16
WIDTH: 30 in.	
024063010	28 9/16 x 10
02406301718	28 9/16 x 17 1/8
02406302412	28 9/16 x 24 1/2
02406303158	28 9/16 x 31 5/8
02406303878	28 9/16 x 38 7/8
024063036516	28 9/16 x 36 5/16
02406304358	28 9/16 x 43 5/8
02406304618	28 9/16 x 46 1/8
024063048	28 9/16 x 48
0240630501316	28 9/16 x 50 13/16
WIDTH: 36 in.	
024063610	34 9/16 x 10
02406361718	34 9/16 x 17 1/8
02406362412	34 9/16 x 24 1/2
02406363158	34 9/16 x 31 5/8
02406363878	34 9/16 x 38 7/8
024063636516	34 9/16 x 36 5/16
02406364358	34 9/16 x 43 5/8
02406364618	34 9/16 x 46 1/8
024063648	34 9/16 x 48
0240636501316	34 9/16 x 50 13/16
WIDTH: 48 in.	
024064810	46 9/16 x 10
02406481718	46 9/16 x 17 1/8
02406482412	46 9/16 x 24 1/2
02406483158	46 9/16 x 31 5/8
02406483878	46 9/16 x 38 7/8
024064836516	46 9/16 x 36 5/16
02406484358	46 9/16 x 43 5/8
02406484618	46 9/16 x 46 1/8
024064848	46 9/16 x 48
0240648501316	46 9/16 x 50 13/16

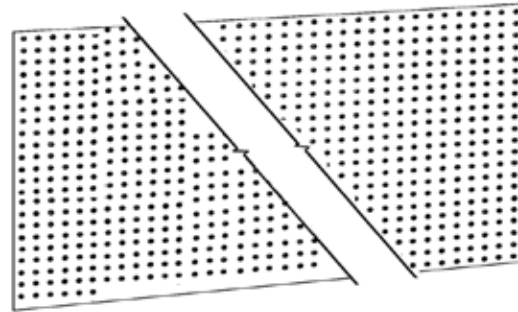

COMPONENTS

E SERIES METAL BACKING

SB CODE	ANJOU CODE E SERIES	MEASURE (IN.)
PLAIN		
	002010712	7 1/4 x 10 9/16 (12)
	002011412	14 1/4 x 10 9/16 (12)
	002010724	7 1/4 x 22 9/16 (24)
	002011424	14 1/4 x 22 9/16 (24)
	002010730	7 1/4 x 22 9/16 (30)
SPECIAL ORDER	002011430	14 1/4 x 22 9/16 (30)
	002010736	7 1/4 x 22 9/16 (36)
	002011436	14 1/4 x 22 9/16 (36)
	002010742	7 1/4 x 22 9/16 (42)
	002011442	14 1/4 x 22 9/16 (42)
	002010748	7 1/4 x 22 9/16 (48)
	002011448	14 1/4 x 22 9/16 (48)
PERFORATED		
	002021412	14 1/4 x 10 9/16 (12)
	002021424	14 1/4 x 22 9/16 (24)
SPECIAL ORDER	002021430	14 1/4 x 28 9/16 (30)
	002021436	14 1/4 x 34 9/16 (36)
	002021442	14 1/4 x 40 9/16 (42)
	002021448	14 1/4 x 46 9/16 (48)

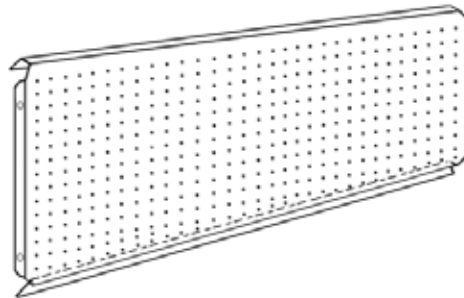
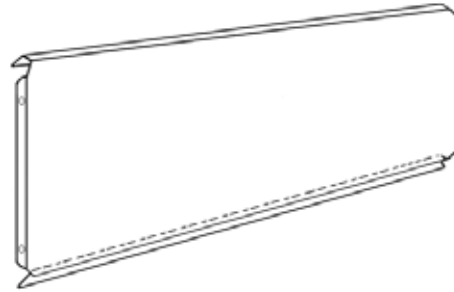

JOINER FOR MASONITE BACKING

SB CODE	ANJOU CODE	MEASURE (IN.)
PLASTIC - AVAILABLE IN WHITE, GREY AND ALMOND ONLY		
E024071324	024071324	24
E024071330	024071330	30
E024071336	024071336	36
E024071342	024071342	42
E024071348	024071348	48
METAL		
E024070324	024070324	24
E024070330	024070330	30
E024070336	024070336	36
E024070342	024070342	42
E024070348	024070348	48

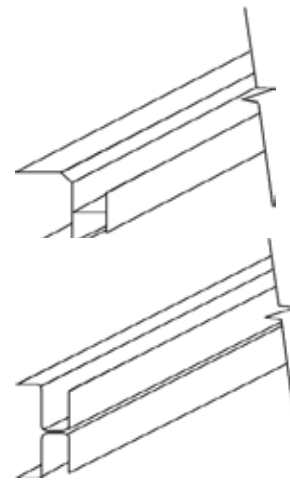

MASONITE SHEET - AVAILABLE IN WHITE, BEIGE SARGASSE, DUST GREY AND BLACK ONLY

SB CODE	MEASURE (IN.)	
007-04-4896	48 x 96	Plain
007-05-4896	48 x 96	Perforated

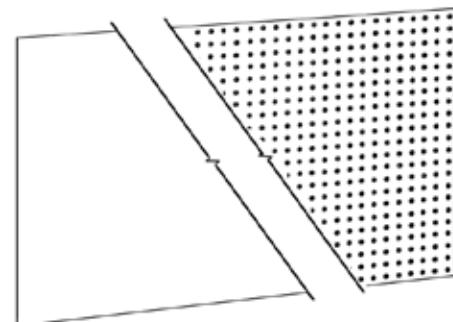

COMPONENTS

E SERIES BOTTOM TIE BAR

SB CODE	ANJOU CODE	MEASURE (IN.)
FOR SINGLE UPRIGHT		
009-01-0024	-	24
009-01-0030	-	30
009-01-0036	-	36
009-01-0048	-	48
FOR DOUBLE UPRIGHT		
009-02-0024	024070124	24
009-02-0030	024070130	30
009-02-0036	024070136	36
009-02-0048	024070148	48

TOP CAP FOR MASONITE BACKING

SB CODE	MEASURE (IN.)	MEASURE (IN.)
REGULAR FOR SINGLE UPRIGHT		
010-01-0024	-	24
010-01-0030	-	30
010-01-0036	-	36
010-01-0048	-	48
U-SHAPED FOR SINGLE UPRIGHT		
010-04-0124	-	24
010-04-0130	-	30
010-04-0136	-	36
010-04-0148	-	48
Z-SHAPED FOR SINGLE UPRIGHT - with angle for masonite backing		
010-03-0024	-	24
010-03-0030	-	30
010-03-0036	-	36
010-03-0048	-	48
REGULAR FOR DOUBLE UPRIGHT - with angle for masonite backing		
010-02-0024	007010024	24
010-02-0030	007010030	30
010-02-0036	007010036	36
010-02-0048	007010048	48
WITH ANCHOR FOR DOUBLE UPRIGHT - with angle for masonite backing		
043-00-0124	-	24
043-00-0130	-	30
043-00-0136	-	36
043-00-0148	-	48

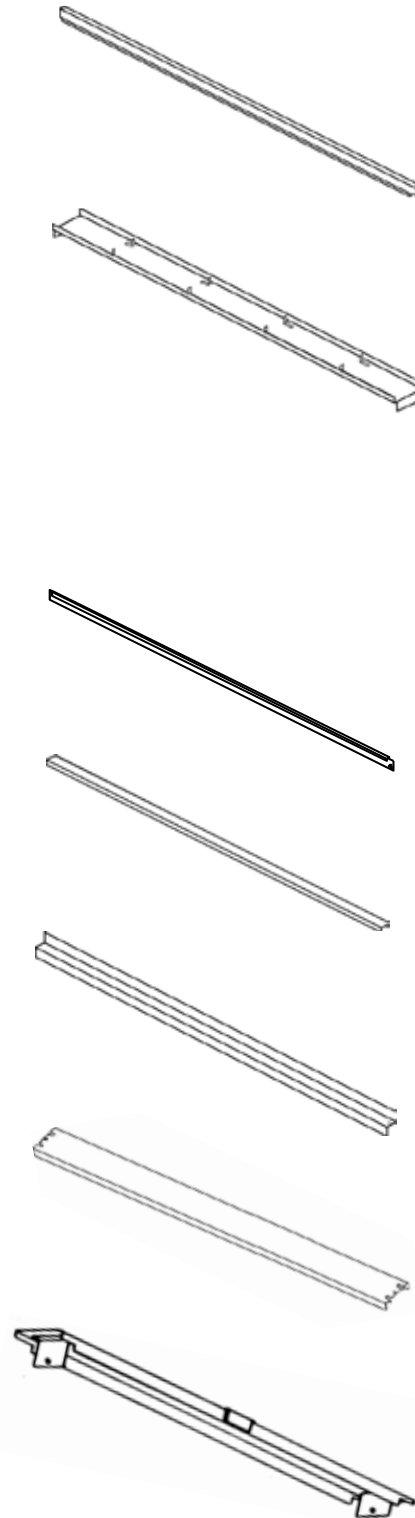

COMPONENTS

TOP CAP FOR METAL BACKING

SB CODE	ANJOU CODE	MEASURE (IN.)
U-SHAPED FOR SINGLE UPRIGHT		
010-04-0024	007150024	24
010-04-0030	007150030	30
010-04-0036	007150036	36
010-04-0048	007150048	48
Z-SHAPED FOR SINGLE UPRIGHT		
010-06-0024	-	24
010-06-0030	-	30
010-06-0036	-	36
010-06-0048	-	48
REGULAR FOR DOUBLE UPRIGHT - without backing angle		
010-01-0124	007010024	24
010-01-0130	007010030	30
010-01-0136	007010036	36
010-01-0148	007010048	48
WITH ANCHOR FOR DOUBLE UPRIGHT - without backing angle		
043-00-0024	007010624	24
043-00-0030	007010630	30
043-00-0036	007010636	36
043-00-0048	007010648	48

UNIVERSAL T CAP (3 pcs x 48 in.) FOR END CAP HARDWARE INCLUDED

ANJOU CODE	MEASURE (IN.)
C07030124	24
C07030130	30
C07030136	36
C07030142	42
C07030148	48

S SERIES END DISPLAY CAP CLIP

ANJOU CODE	MEASURE (IN.)
207010203	4 1/16

ETALEX S END DISPLAY CAP CLIP

ANJOU CODE	MEASURE (IN.)
007010203	3 9/16

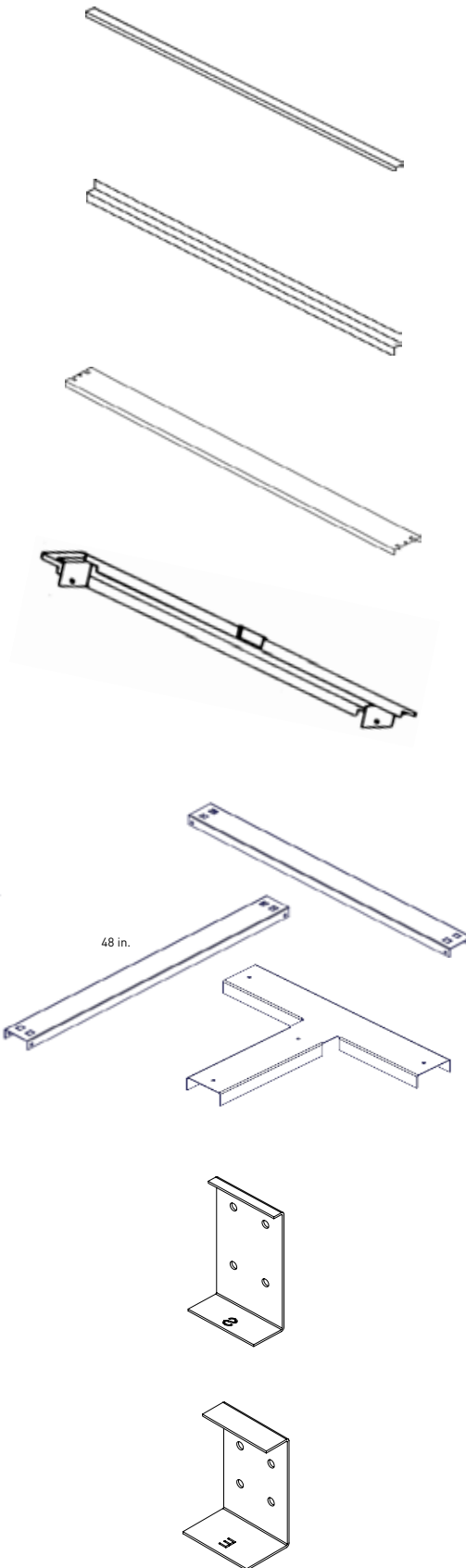

COMPONENTS

GALVANIZED CROSSBAR

SB CODE	ANJOU CODE	MEASURE (IN.)
REGULAR		
011-01-0024	024070424	24
011-01-0030	024070430	30
011-01-0036	024070436	36
011-01-0048	024070448	48
HEAVY DUTY		
011-01-0124	-	24
011-01-0130	-	30
011-01-0136	024070536	36
011-01-0148	024070548	48

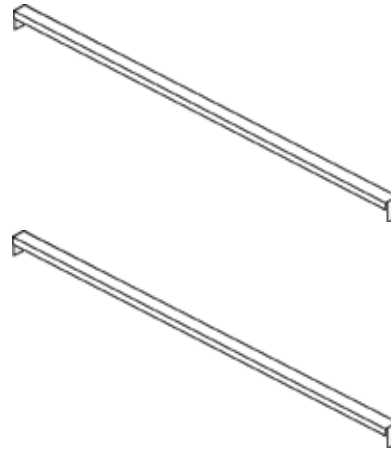

E SERIES CROSSBAR

SB CODE	ANJOU CODE	MEASURE (IN.)
REGULAR		
E025040024	025040024	24
E025040030	025040030	30
E025040036	024040036	36
E025040042	-	42
E025040048	024040048	48
HEAVY DUTY		
011-02-0124	B011020124	24
011-02-0130	B011020130	30
011-02-0136	B011020136	36
011-02-0148	B011020148	48

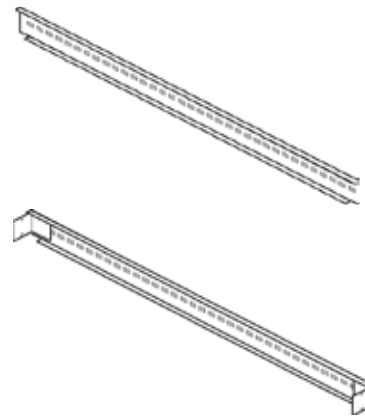

E SERIES KICKPLATE

SB CODE	ANJOU CODE	MEASURE (IN.)
REGULAR		
004-01-0024	005010024	24
004-01-0030	005010030	30
004-01-0036	005010042	36
004-01-0048	005010048	48
FOR BACK		
004-02-0024	005020024	24
004-02-0030	005020030	30
004-02-0036	005020036	36
004-02-0048	005020048	48

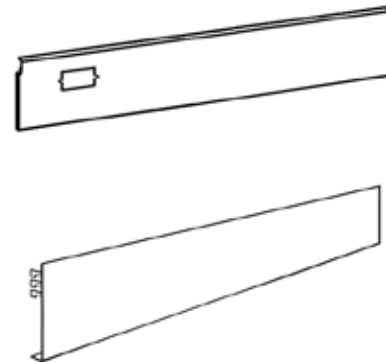

COMPONENTS

E SERIES FINISHING CAP

SB CODE	ANJOU CODE	
010-01-0000	530CAPRECT3ETALEX	Black
-	530CAPRECT3ETALEXB	White

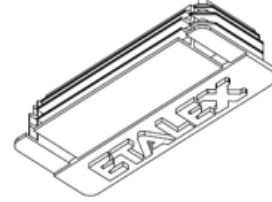

SHOE GUARD

SB CODE	MEASURE (IN.)
004-10-C001	Center
004-10-0001	End
004-10-0002	End with power outlet box

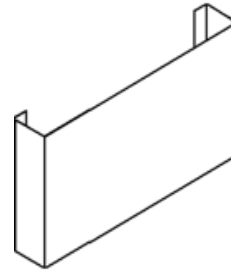

SHOE GUARD E SERIES

ANJOU CODE	MEASURE (IN.)	
005-07-0003	3	End
005-07-0007	7	End
005-07-0004	12	End
005-07-0002	3	Center
005-07-0005	12	Center

PRODUCTS AND PARTS CATALOG



www.etalex.ca

CONTACT US

ANJOU PLANT

850 Jarry Street East
Montreal (QC) H1J 1H7

SAINT-BRUNO PLANT

1299 Marie-Victorin Street
St-Bruno (QC) J3V 6B7

RAY-LAWSON PLANT

10251 Ray-Lawson Blvd.
Anjou (QC) H1J 1L6

T 514 351-2000

TF 1 800 351-3125



FACEBOOK/ETALEX



LINKEDIN/ETALEX



YOUTUBE/ETALEX

MADE IN CANADA 